

2012
AMTA
20Years

The Tenth Biennial Conference of the
Association for Machine Translation in the Americas

Open Source Statistical Machine Translation



Philipp Koehn
University of Edinburgh

Hieu Hoang
University of Edinburgh

SAN DIEGO, CA
OCTOBER 28- NOVEMBER 1, 2012

If you are interested in open-source machine translation but lack hands-on experience, this is the tutorial for you!

We will start with background knowledge of statistical machine translation and then walk you through the process of installing and running an SMT system. We will show you how to prepare input data, and the most efficient way to train and use your translation systems. We shall also discuss solutions to some of the most common issues that face LSPs when using SMT, including how to tailor systems to specific clients, preserving document layout and formatting, and efficient ways of incorporating new translation memories.

Previous years' participants have included software engineers and managers who need to have a detailed understanding of the SMT process. This is a fast-paced, hands-on tutorial that will cover the skills you need to get you up and running with open-source SMT.

The teaching will be based on the Moses toolkit, the most popular open-source machine translation software currently available. No prior knowledge of MT is necessary, only an interest in it. A laptop is required for this tutorial, and you should have rudimentary knowledge of using the command line on Windows or Linux.

Presenters

- Philipp Koehn, PhD, Professor for Machine Translation at the University of Edinburgh.
- Hieu Hoang, PhD, Research Assistant in the Machine Translation group at the University of Edinburgh

MOSES

Machine Translation with Open Source Software

Philipp Koehn and Hieu Hoang

1 November 2012



Outline



09:30-10:00 Introduction

10:00-11:00 Hands-on Session — you will need a laptop

11:00-11:30 Break

11:30-12:30 Advanced Topics

Basic Idea

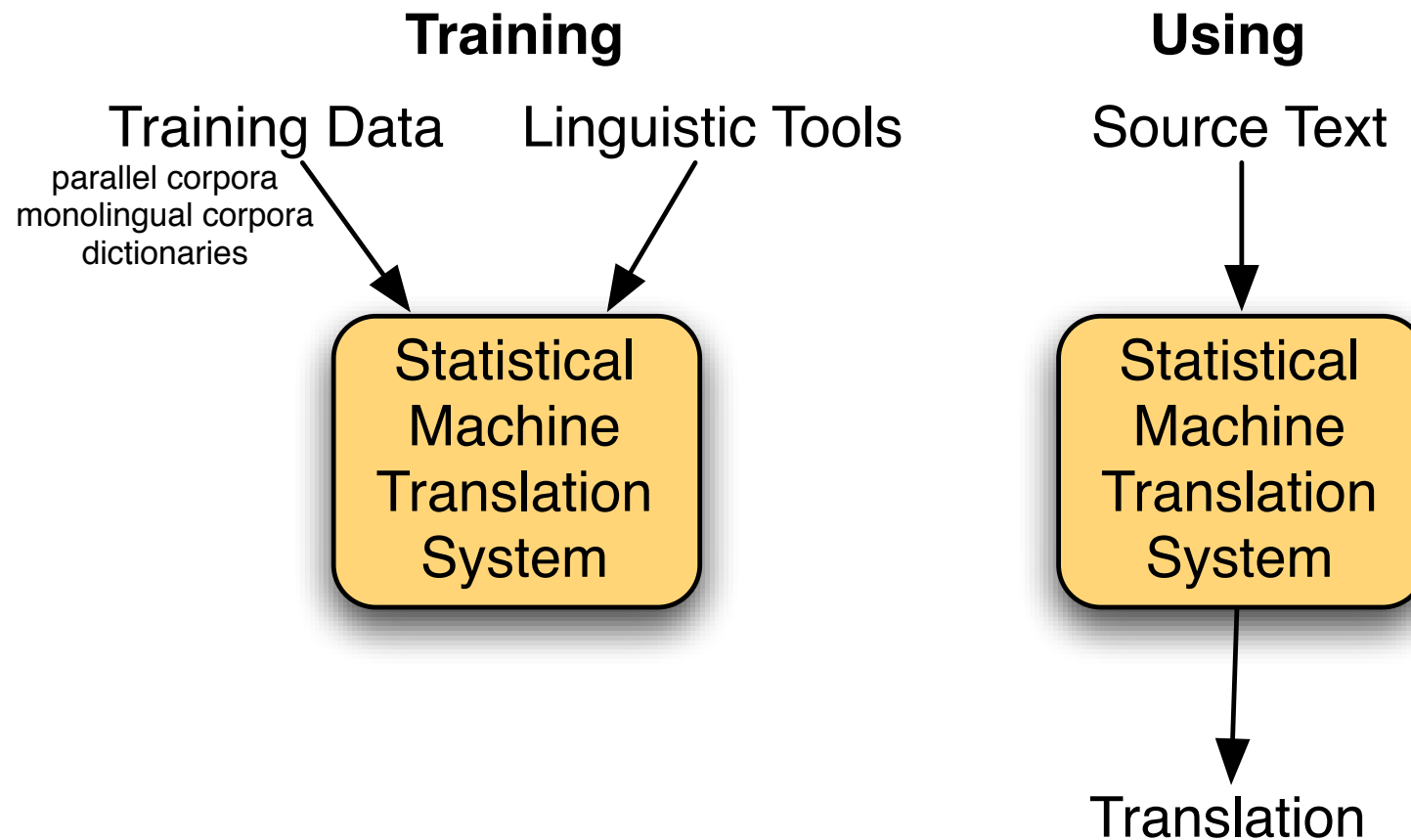

Statistical Machine Translation History



around 1990

Pioneering work at IBM, inspired by success in speech recognition

1990s

Dominance of IBM's word-based models, support technologies

early 2000s

Phrase-based models

late 2000s

Tree-based models

Moses History

- 2002** Pharaoh decoder, precursor to Moses (phrase-based models)
- 2005** Moses started by Hieu Hoang and Philipp Koehn (factored models)
- 2006** JHU workshop extends Moses significantly
- since late 2006** Funding by EU projects EuroMatrix, EuroMatrixPlus
- 2009** Tree-based models implemented in Moses
- 2012** MosesCore project. Full-time staff to maintain and enhance Moses

Moses in Academia

- Built by academics, for academics
- Reference implementation of state of the art
 - researchers develop new methods on top of Moses
 - developers re-implement published methods
 - used by other researchers as black box
- Baseline to beat
 - researchers compare their method against Moses



Developer Community

- Main development at University of Edinburgh, but also:
 - Fondazione Bruno Kessler (Italy)
 - Charles University (Czech Republic)
 - DFKI (Germany)
 - RWTH Aachen (Germany)
 - others...
- Code shared on github.com
- Main forum: support and developer mailing lists
- Main event: Machine Translation Marathon (next: 2013, Prague)
 - annual open source convention
 - presentation of new open source tools
 - hands-on work on new open source projects
 - summer school for statistical machine translation

Open Source Components



- Moses distribution uses external open source tools
 - word alignment: GIZA++, MGIZA, Berkeley aligner
 - language model: SRILM, IRSTLM, RANDLM
 - scoring: BLEU, TER, METEOR
- Other useful tools
 - sentence aligner
 - syntactic parsers
 - part-of-speech taggers
 - morphological analyzers



Other Open Source MT Systems

- **Joshua** — Johns Hopkins University
<http://joshua.sourceforge.net/>
- **CDec** — University of Maryland
<http://cdec-decoder.org/>
- **Jane** — RWTH Aachen
<http://www-i6.informatik.rwth-aachen.de/jane/>
- Very similar technology
 - Joshua implemented in Java, others in C++
 - Joshua and Jane support only tree-based models
 - Phrasal supports only phrase-based models
- Open sourcing tools increasing trend in NLP research

Moses in Industry



- Distributed with LGPL — free to use
- Competitive with commercial SMT solutions (Language Weaver, Google, ...)
- But:
 - not easy to use
 - requires significant expertise for optimal performance
 - integration into existing workflow not straight-forward

Case Studies



European Commission —

uses Moses in-house to aid human translators

Autodesk —

showed productivity increases in translating manuals when post-editing output from a custom-build Moses system

Systran —

developed statistical post-editing using Moses

Asia Online —

offers translation technology and services based on Moses

Many others ...

World Trade Organisation, Adobe, Symantec, WIPO, Sybase, Safaba

Phrase-Based Model

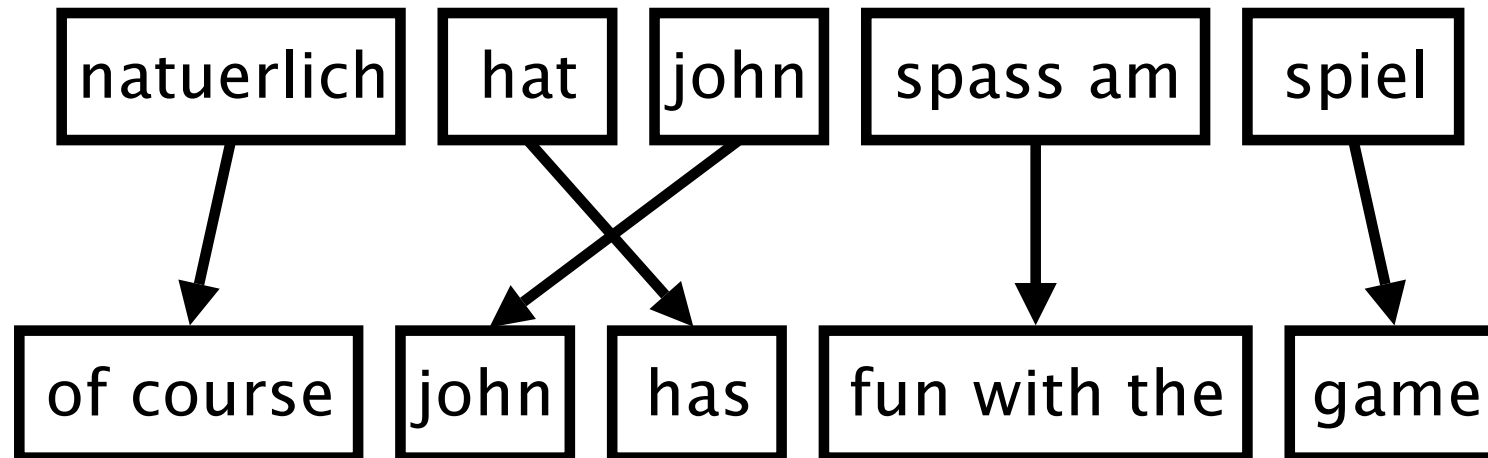

- Foreign input is segmented in phrases
- Each phrase is translated into English
- Phrases are reordered

Phrase Translation Options

er	geht	ja	nicht	nach	hause
he	is	yes	not	after	house
it	are	is	do not	to	home
, it	goes	, of course	does not	according to	chamber
, he	go	,	is not	in	at home
it is		not		home	
he will be		is not		under house	
it goes		does not		return home	
he goes		do not		do not	
	is		to		
	are		following		
	is after all		not after		
	does		not to		
	not				
	is not				
	are not				
	is not a				

- Many translation options to choose from

Phrase Translation Options

er	geht	ja	nicht	nach	hause
he	is	yes	not	after	house
it	are	is	do not	to	home
, it	goes	, of course	does not	according to	chamber
, he	go		is not	in	at home
it is		not		home	
he will be		is not		under house	
it goes		does not		return home	
he goes		do not		do not	
	is		to		
	are		following		
	is after all		not after		
	does		not to		
	not				
	is not				
	are not				
	is not a				

- The machine translation decoder does not know the right answer
 - picking the right translation options
 - arranging them in the right order
- Search problem solved by heuristic beam search

Decoding: Precompute Translation Options¹⁴

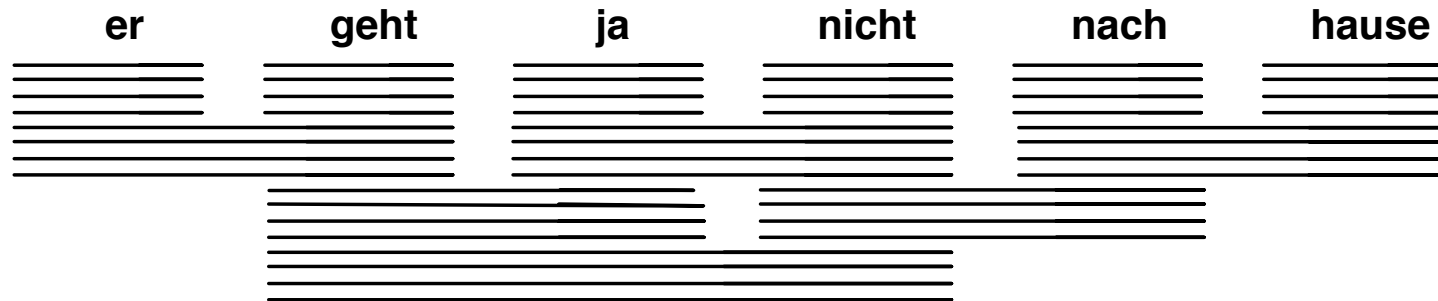

consult phrase translation table for all input phrases

Decoding: Start with Initial Hypothesis

15

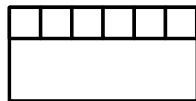
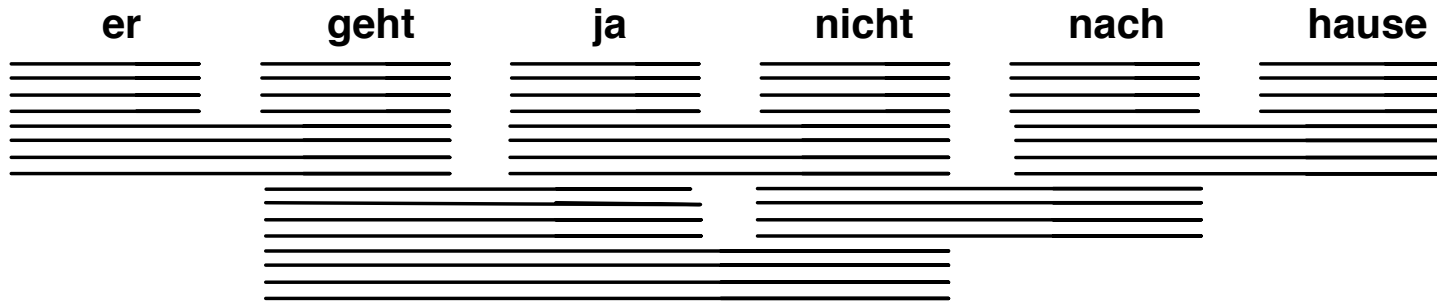

initial hypothesis: no input words covered, no output produced

Decoding: Hypothesis Expansion

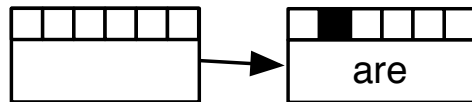
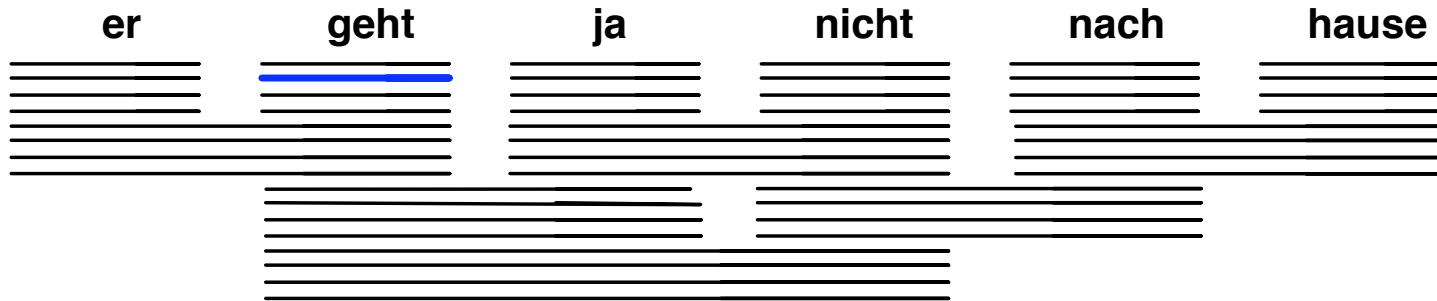

pick any translation option, create new hypothesis

Decoding: Hypothesis Expansion

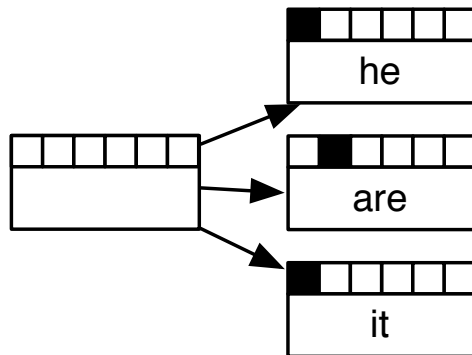
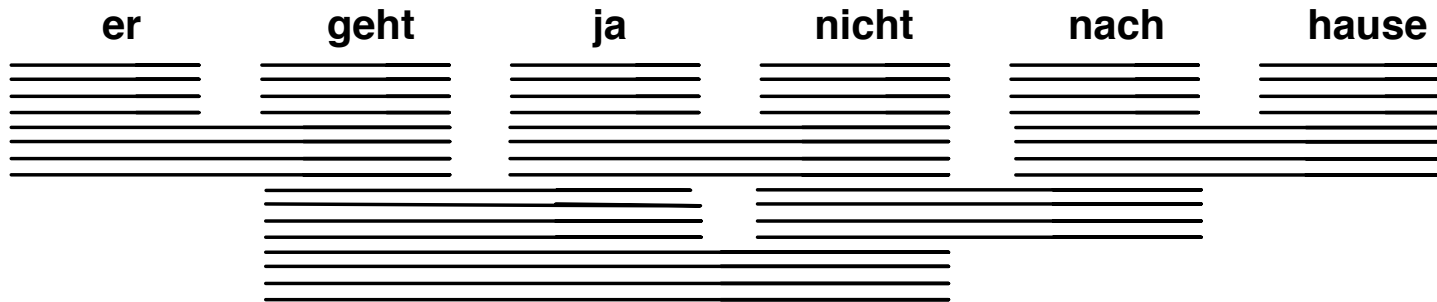

create hypotheses for all other translation options

Decoding: Hypothesis Expansion

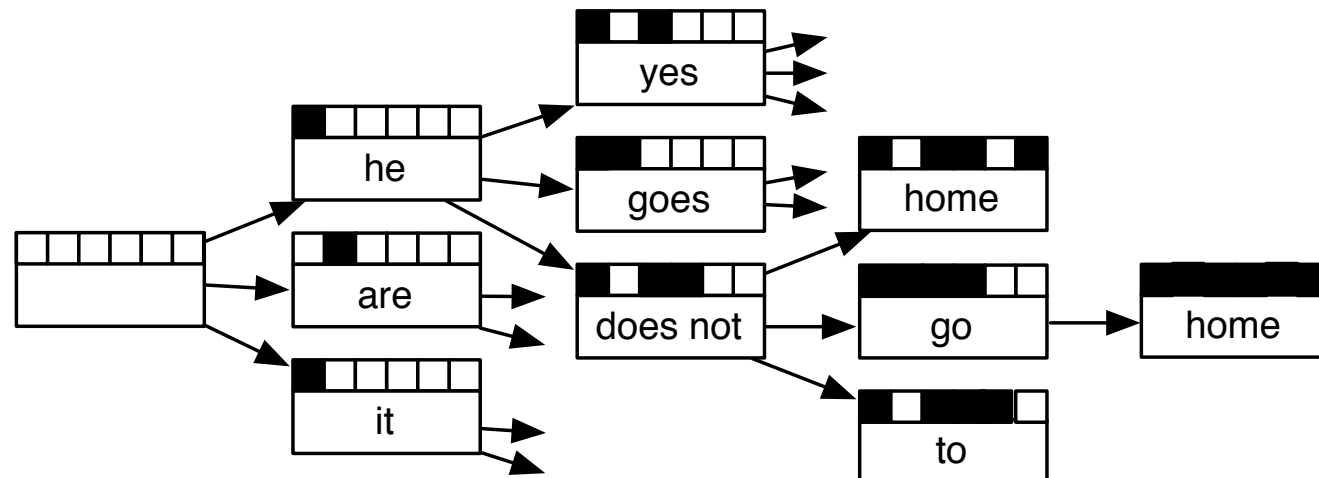
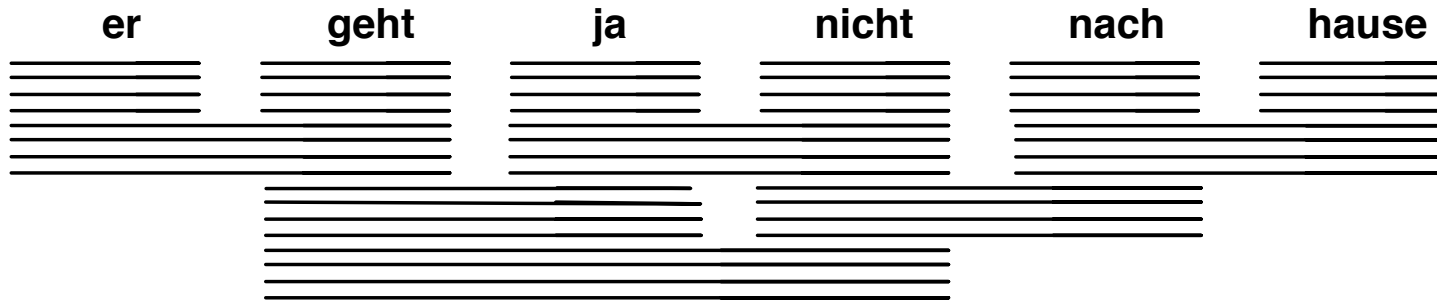

also create hypotheses from created partial hypothesis

Decoding: Find Best Path

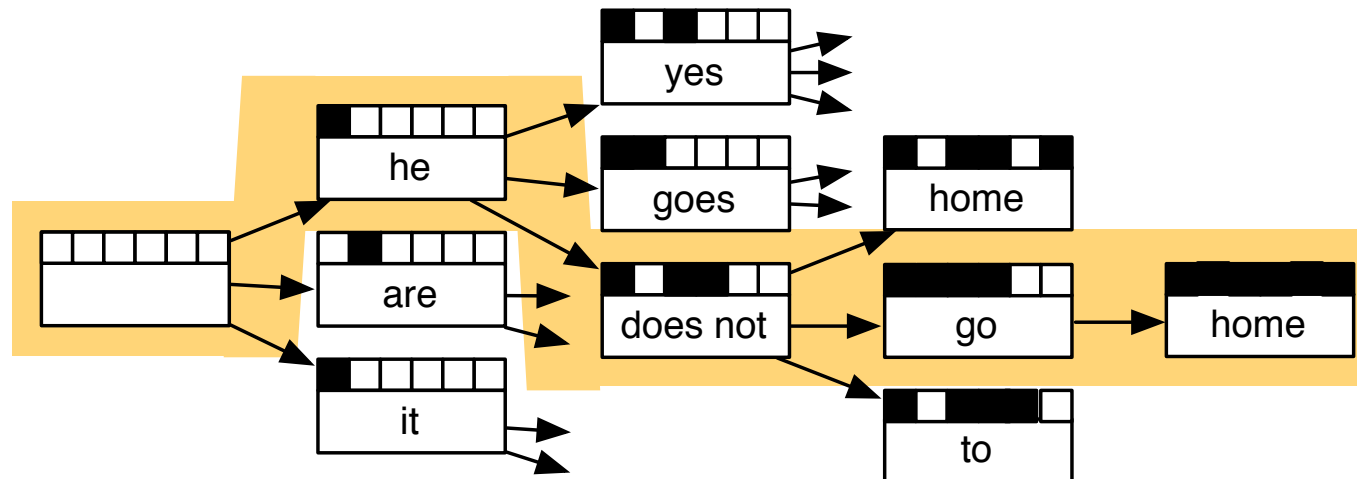
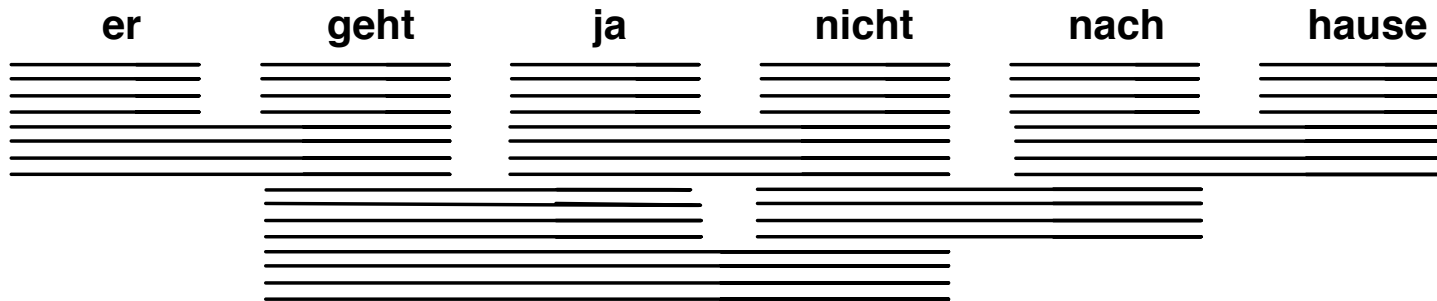

backtrack from highest scoring complete hypothesis

Computational Complexity



- The suggested process creates exponential number of hypothesis
 - Reduction of search space: pruning
- Decoder may not find the model-best translation

Factored Representation

- Factored representation of words

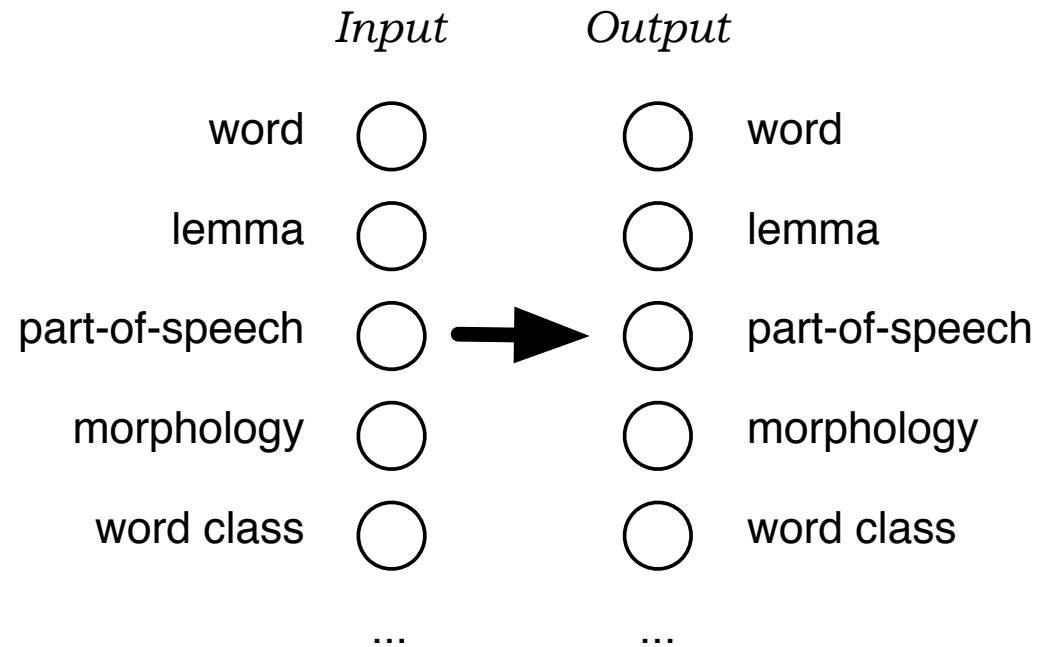

- Goals
 - generalization, e.g. by translating lemmas, not surface forms
 - richer model, e.g. using syntax for reordering, language modeling)

Factored Model

Example:

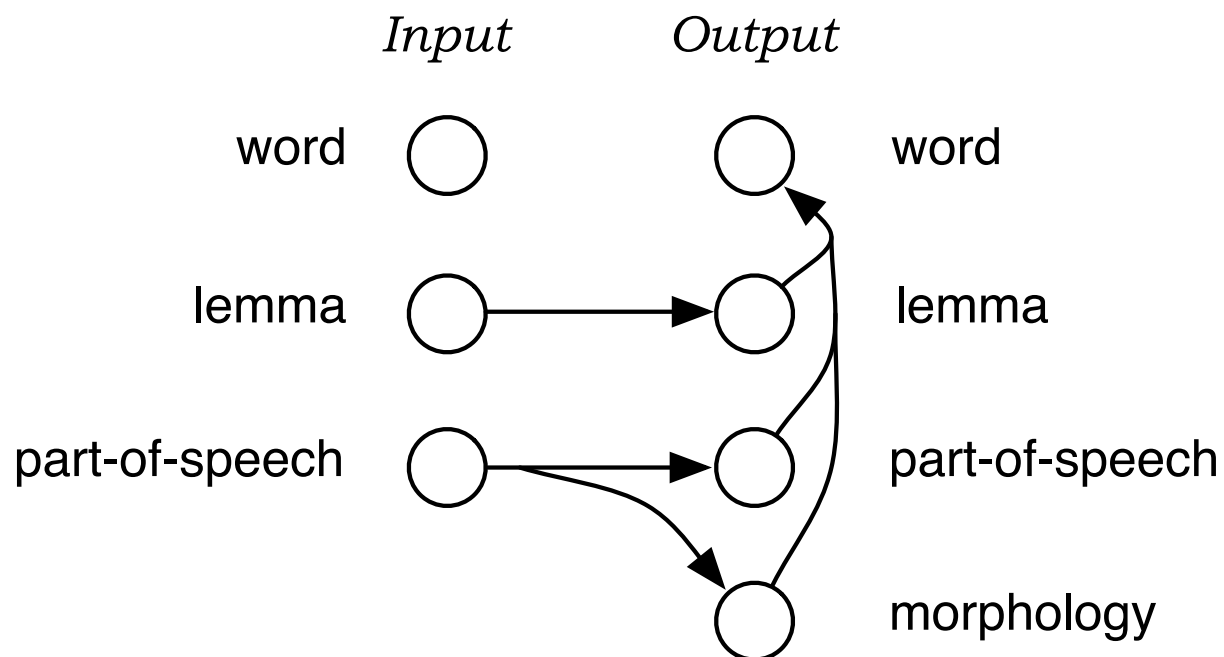

Decomposing the translation step

Translating lemma and morphological information more robust

Syntax Models

String to String

John misses Mary

⇒ Marie manque à Jean

String to Tree

John misses Mary

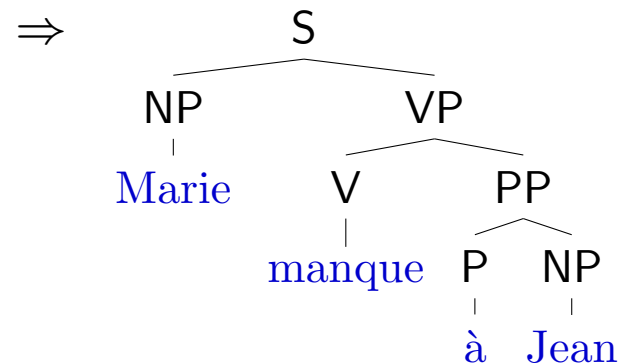

Tree to String

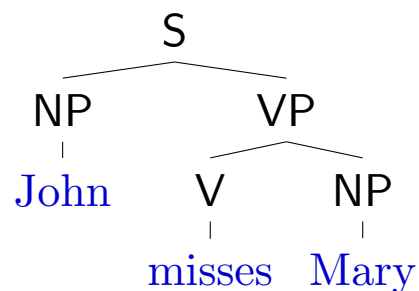

⇒ Marie manque à Jean

Tree to Tree

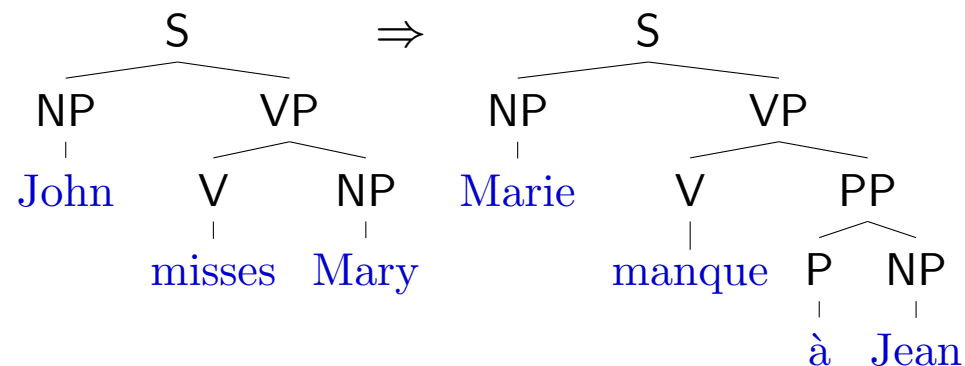

Syntax Decoding

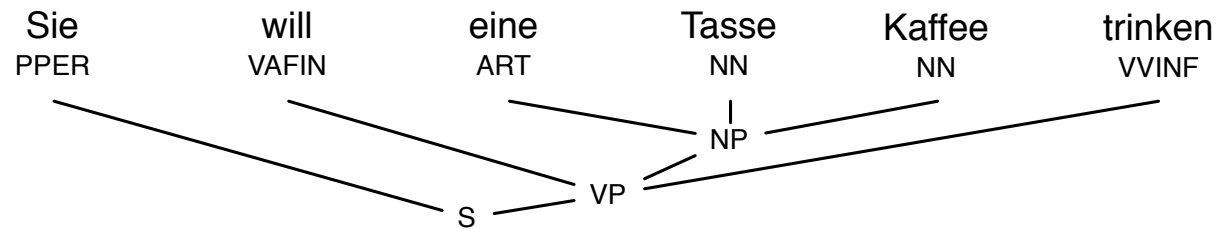

Syntax Decoding

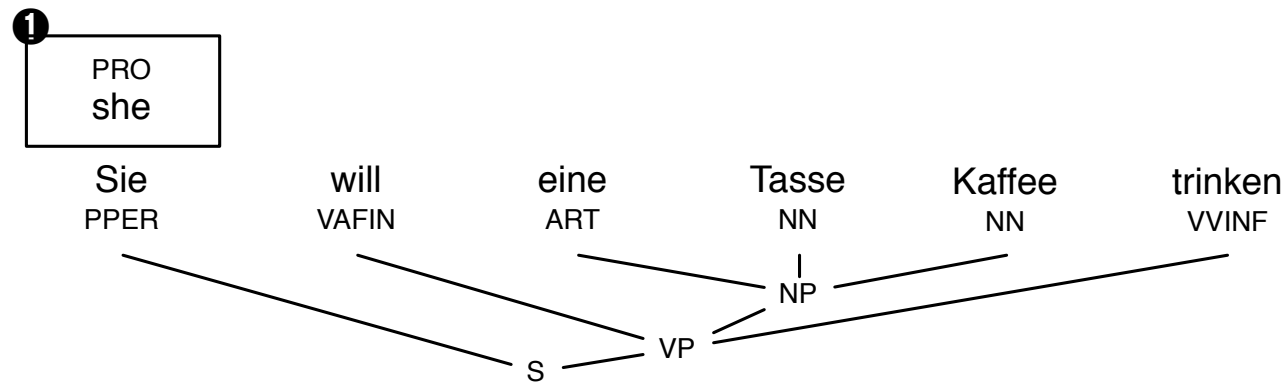

Syntax Decoding

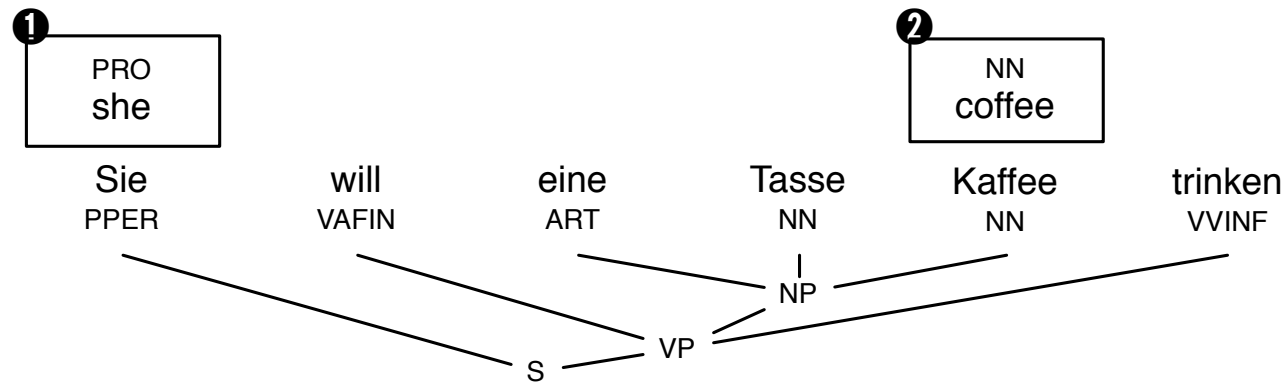

Syntax Decoding

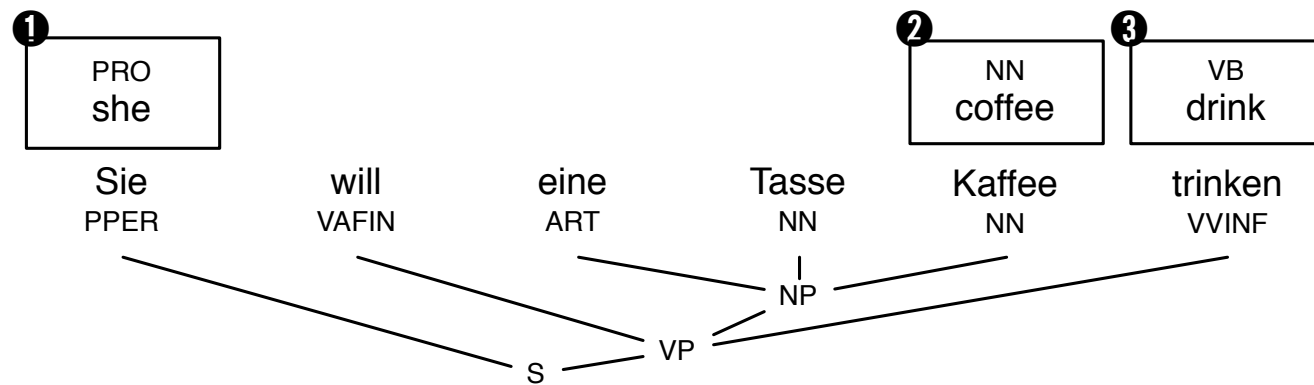

Syntax Decoding

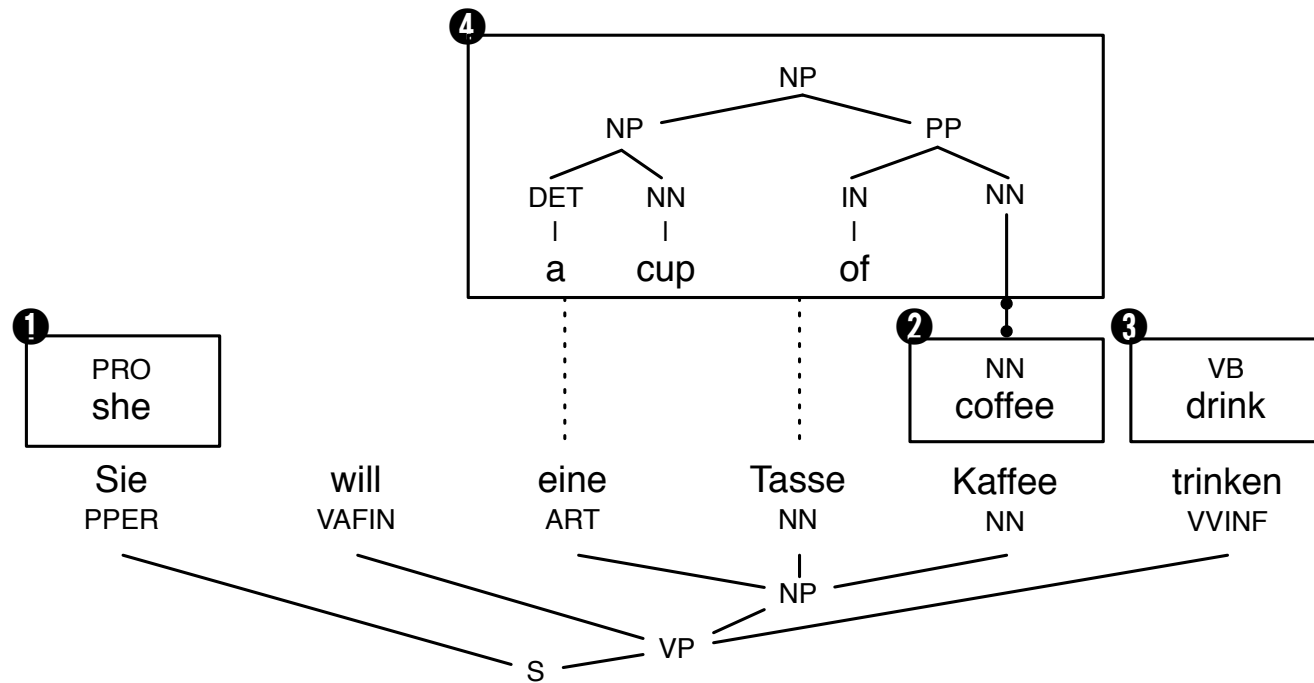

Syntax Decoding

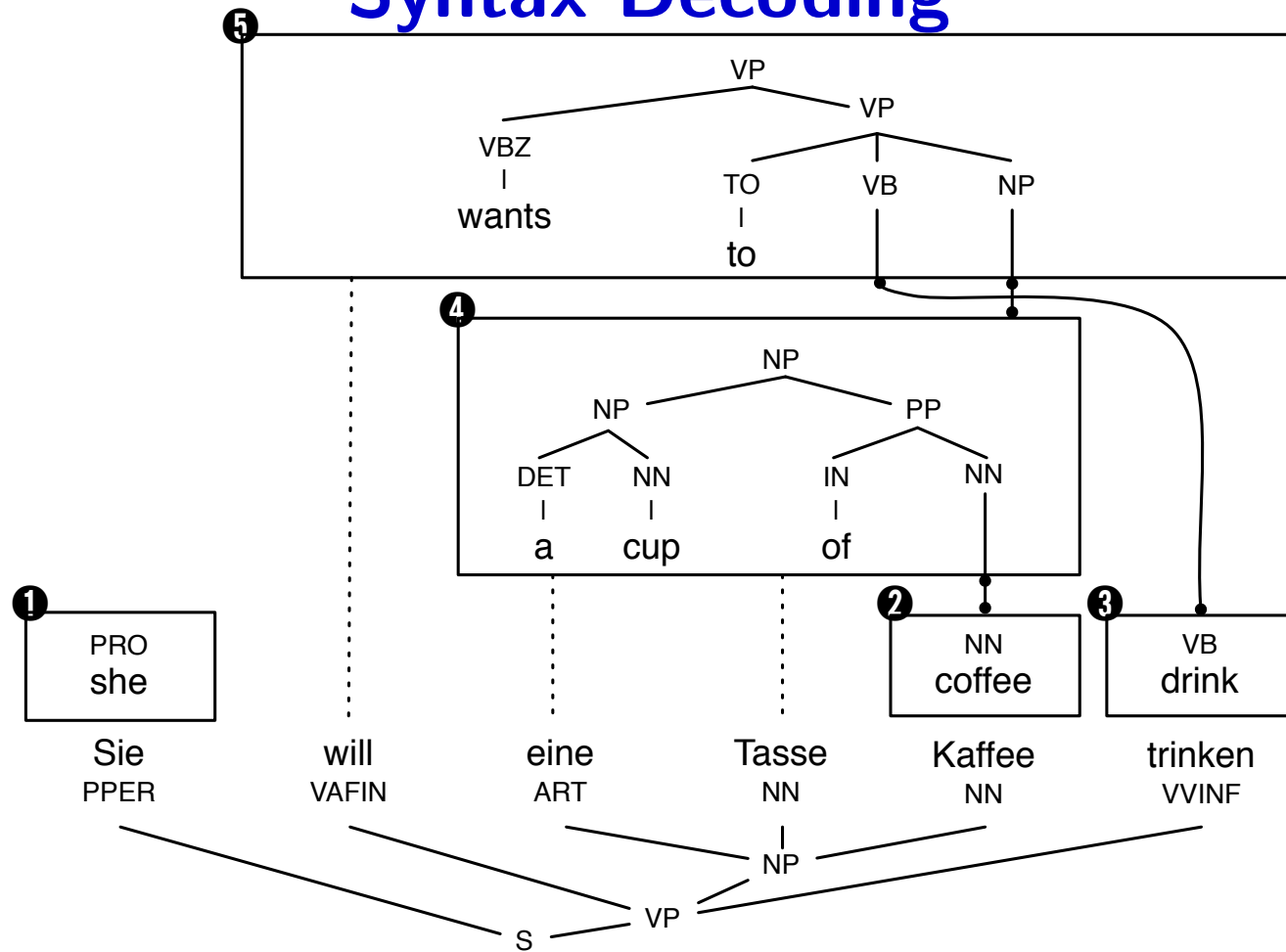

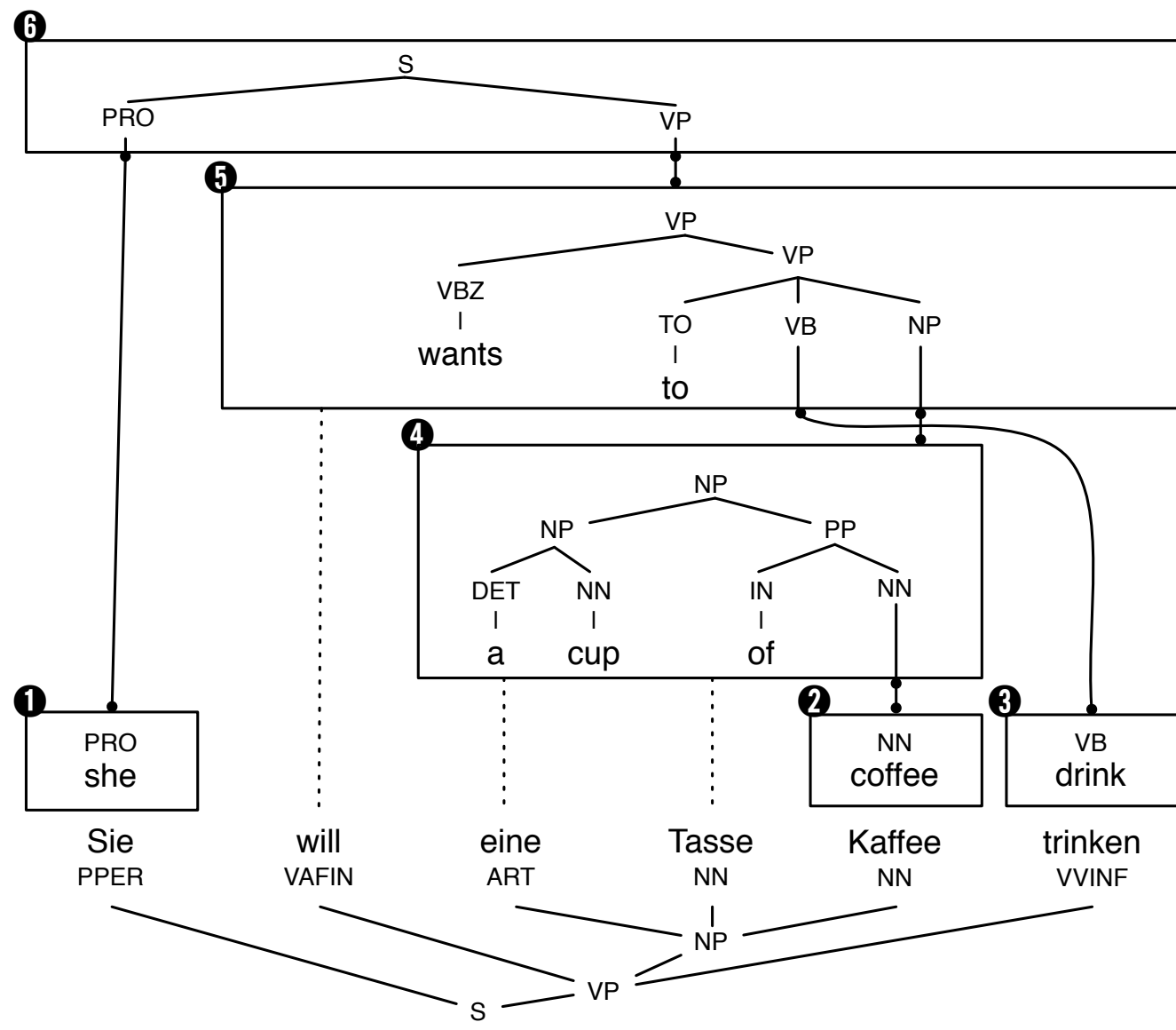

Advanced Features



- **How do I get started?**
- Experiment Management System
- Faster Training
- Faster Decoding
- Moses Server
- Data and domain adaptation
- Instructions to decoder
- Input formats
- Output formats
- Translation models

How do I get started?

- Collect your data
 - Parallel data
 - Translation memories
 - Open-sourced data, eg. Europarl, UN, TAUS Data Association
 - Monolingual data
- Set up Moses
 - Download source code for Moses, GIZA++, MGIZA
 - Compile, install
 - More info: <http://www.statmt.org/moses/>
 - Prepackaged Moses: Precision Tools, MacPorts, Debian packages, M4Loc

How do I get started?

Execute a lot of scripts

```
tokenize < corpus.en > corpus.en.tok  
lowercase < corpus.en.tok > corpus.en.lc  
...  
mert.perl ....  
moses ...  
mteval-v13.pl ...
```

Change a part of the process, execute everything again

```
tokenize < corpus.en > corpus.en.tok  
lowercase < corpus.en.tok > corpus.en.lc  
...  
mert.perl ....  
moses ...  
mteval-v13.pl ...
```

Advanced Features



- How do I get started?
- **Experiment Management System**
- Faster Training
- Faster Decoding
- Moses Server
- Data and domain adaptation
- Instructions to decoder
- Input formats
- Output formats
- Translation models

Experiment Management System



- One configuration file for all settings: record of all experimental details
- Scheduler of individual steps in pipeline
 - automatically keeps track of dependencies
 - runs on single machine, multi-core machine, GridEngine cluster
 - parallel execution
 - crash detection
 - automatic re-use of prior results
- Fast to use
 - set up a new experiment in minutes
 - set up a variation of an experiment in seconds
- Disadvantage — not all Moses features are integrated

Workflow automatically generated by experiment.perl

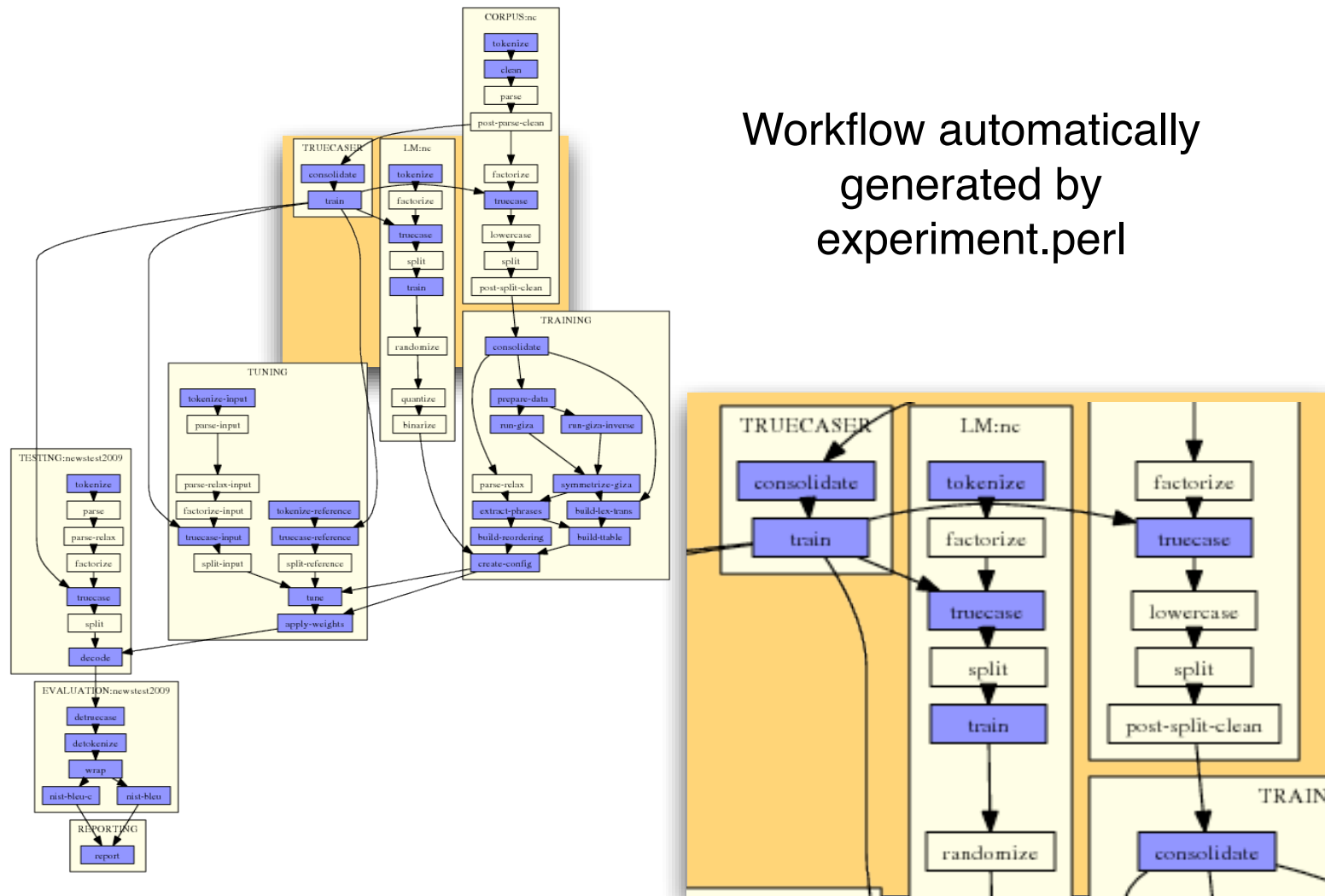

How does it work?

- Write a configuration file (typically by adapting an existing file)

- Test:

```
experiment.perl -config config
```

- Execute:

```
experiment.perl -config config -exec
```

Web Interface



All Experimental Setups

ID	User	Task	Directory
97	pkoehn	Acquis Truecased	/group/project/statmt2/pkoehn/acquis-truecase
96	pkoehn	Chinese-English AGILE 2008	/group/project/statmt2/pkoehn/agile08-chinese
95	miles	Randlm testing	/group/project/statmt7/miles/experiments /ep-enfr/work
94	joseph	Proj2008 Impl.Adapted experiment(fr-en)for News Comm.	/group/project/statmt2/joseph/experimentJo/task6
93	joseph	Proj2008 Impl.Baseline experiment(fr-en)for News Comm.	/group/project/statmt2/joseph/experimentJo/task5
92	jschroe1	FR-EN System Combination Components	/group/project/statmt9/josh/experiments /fr-syscomb/work

List of experiments

List of Runs

Task: WMT10 German-English (pkoehn)

[Wiki Notes](#) | [Overview of experiments](#) | [/fs/bragi2/pkoehn-experiment/wmt10-de-en](#)

<input type="checkbox"/> compare	ID	start	end	avg	newstest2009		newstest2010	
<input type="checkbox"/> cfglparlimg	[1042-16] 11+analysis	16 May	16 May	BLEU-c: 21.74 BLEU: 22.91	21.03 (1.002)	<input type="checkbox"/> A	22.45 (1.041)	<input type="checkbox"/> A
<input type="checkbox"/> cfglparlimg	[1042-15] 11+Internal emplus test set	21 Apr	crashed	-	-		-	
<input type="checkbox"/> cfglparlimg	[1042-14] 9+interpolated-tm.lm-weighted	21 Feb	21 Feb 9: 0.239258 -> 0.239296	-	20.81 (1.003)	<input type="checkbox"/> A	-	
<input type="checkbox"/> cfglparlimg	[1042-13] 9+only-ep	21 Feb	21 Feb 13: 0.235046 -> 0.235053	-	22.06 (1.003)	<input type="checkbox"/>	-	
<input type="checkbox"/> cfglparlimg	[1042-12] 9+only-nc	21 Feb	21 Feb 7: 0.222237 ->	-	20.42 (1.002)	<input type="checkbox"/> A	-	
<input type="checkbox"/> cfglparlimg					21.69 (1.002)	<input type="checkbox"/>		
					18.96 (1.002)	<input type="checkbox"/> A		
					20.16	<input type="checkbox"/>		

Analysis: Basic Statistics

Coverage			Phrase Segmentation				
	model	corpus		1	2	3	4+
0	2047 (3.1%)	1708 (2.6%)	1 to	26897 (40.7%)	2145 (3.2%)	278 (0.4%)	90 (0.1%)
1	738 (1.1%)	518 (0.8%)	2 to	4144 (6.3%)	14414 (21.8%)	2518 (3.8%)	432 (0.7%)
2-5	1483 (2.2%)	818 (1.2%)	3 to	639 (1.0%)	3522 (5.3%)	4821 (7.3%)	1272 (1.9%)
6+	61745 (93.5%)	62969 (95.4%)	4+ to	158 (0.2%)	855 (1.3%)	1693 (2.6%)	2135 (3.2%)
	by token / by type / details			by word / by phrase			

- Basic statistics
 - n-gram precision
 - evaluation metrics
 - coverage of the input in corpus and translation model
 - phrase segmentations used

Analysis: Unknown Words

grouped by count in test set

unknown words

	4:	3:	2:	1:
18 Eatonville	Eatonvilles,	Anmil,	Abfertigungen,	-Ach, -Minister, -Pakets, -weiss, .docx, .pptx, .xlsx, 1,45,
16 Hurston	Együtt,	Atlasz, BR23C,	Albums, Alondra,	1.106,55, 1.983,73, 10.365,45, 10.579, 10.809,25, 106,85,
12 Barrick	Garver,	BSA, Bayón,	Andoh, Anm., Armiñon,	11,9, 11.743,61, 12.595.75, 14,2, 14,7, 145.29, 16,8, 17,9,
12 Hema	Harmadik,	Biztos, Bt.,	Ashford, BZÖ, Baloldal,	18,6, 18.286,90, 1802, 1834, 1880ern, 1920ern, 1925,
12 Stewards	Hurstons,	Butch, Casado,	Bani, Baugesellschaften,	19252008, 199,61, 2,178, 2,37, 2.400, 26,3, 270.000, 29,2,
11 Gebrselassie	Jobb, Jol,	Dal, Embraer,	Bedienkomfort, Bento,	3,30, 3,632, 3,827, 3.0.0, 4,161, 4,357, 42,2, 43,4, 499,
10 Flamenco	Jos, Jövőért,	FT, Faymann,	Bentos, Bingleys, Bojen,	49sten, 5.839, 506,43, 6,98, 684,81, 729,700, 75,5, 777,68,
10 Mango	Kovalev,	Fiatal, Gregg,	Bowens, Bowery, Boyd,	8,25, 8,81, 9,14, 99,80, AAC, ADQ, ART, Aareal,
9 Glitter	Krever,	Gélineau, HSV,	Bringley, Browser,	Abbremsens, Abhöraktion, Absenzen, Abwesenheiten,
9 ÚOHS	Lados,	Hanzelka,	Bělohávek, CBGB,	Abwiegen, Abwärtssog, Achronot, Actor, AdSense,
9 ČTÚ	Mercandelli,	Illhäusern, Iván,	Carci, Cera, Charts,	AdWords, Aday, Adobe, Adressverzeichnisses, Adwards,
8 Coles	Stehplätze,	Jansen, Jančura,	Chemical, Chigi,	Adélar, Agazio, Akku, Akron, Aktuálně.cz, Alameda,
8 Deka	Tauro,	Joanne,	Cineast, Comics,	Alatriste, Alcolock, Aleš, Alhambra, Alleinregierer,
8 Garci	Tórtola,	Kemrová, Kid,	Commerzbank, Coppola,	Amazonengebiet, Amil, Aminei, Amministrazione, Amway,
8 ITV	Zenobia,	Llamazares,	Corker, Cowon, DF,	Andalusierin, Andik, Android, Anděl, Angeklagtem, Ansa,
	fon,	Loafs, Mangas,	Dinkins, Download,	Anthologie, Antiasthmatica, Apnoe, Aquel, Arabija,
	Évezredért,	Medikamentes,	Drehbewegung,	Arbeiternehmers, Arcandor, Arriaga, Asiana, Askale,
	Ózd	Mobil.cz,	Drzewiecki, Drápal,	Astronomen, Aufeislegen, Augäpfel, Ausdrückstärke,
		Mutual,	Düsseldorfer, Ella,	Ausführungs-, Ausgeruhter, Ausscheidungsspiele,

Analysis: Output Annotation



[0.2152] This time was the reason for the collapse on Wall Street .
[ref] This time the fall in stocks on Wall Street is responsible for the drop .

Color highlighting to indicate n-gram overlap with reference translation
darker bleu = word is part of larger n-gram match

Analysis: Input Annotation

100 occurrences in corpus, 52 distinct translations, translation entropy: 3.08447

[#4]

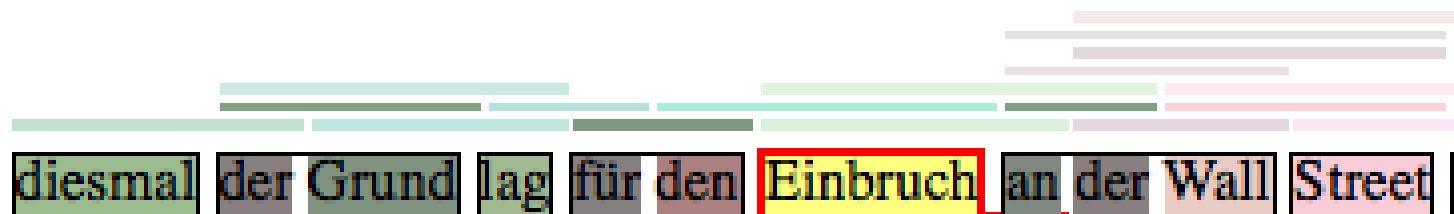

- For each word and phrase, color coding and stats on
 - number of occurrences in training corpus
 - number of distinct translations in translation model
 - entropy of conditional translation probability distribution $\phi(e|f)$ (normalized)

Analysis: Bilingual Concordancer

entre autres(560/1554)

...d and made recommendations , " **inter alia** " , with respect to the follow...
 ...on (EC) No 1995 / 2000 imposing , **inter alia** , a definitive anti @-@ dumping dut...
 ...ervices . this increase , arising , **inter alia** , as a result of economic growth , ...
 ...of paragraph 1 the Commission may , **inter alia** , bring forward :
 ... of stocks of obsolete pesticides , **inter alia** , by supporting projects aimed at s...
 ...wn rules of procedure which shall , **inter alia** , contain provisions for convening ...
 ...uch specific agreements may cover , **inter alia** , financing provisions , assignment...
 ...he internal market and concerning , **inter alia** , health and environmental protecti...
 ...e product concerned) originating , **inter alia** , in Belarus and Russia (the count...
 ...e product concerned) originating , **inter alia** , in India .

... des recommandations concernant , **entre autres** , les questions spécifiques suiva...
 ...995 / 2000 du Conseil instituant , **entre autres** , un droit antidumping définitif ...
 ...nsports . cette augmentation , due **entre autres** facteurs à la croissance économi...
 ...aragraphe 1 , la Commission peut , **entre autres** , présenter :
 ...r les stocks de vieux pesticides , **entre autres** en soutenant des projets à cet ef...
 ...lement intérieur , qui contient , **entre autres** dispositions , les modalités de c...
 ...ords spécifiques peuvent porter , **entre autres** , sur les mécanismes financiers s...
 ...hé intérieur et qui concernent , **entre autres** , la santé et la protection de l&...
 ...it concerné ") originaire , **entre autres** , du Belarus et de Russie (ci @-@ ...
 ...t concerné ") originaires , **entre autres** , de l ' Inde .

notamment(447/1554)

... the EU budget by addressing " **inter alia** " the problems of accountabili...
 ...ates , the Commission has adopted , **inter alia** , Decision 2003 / 526 / EC (3) wh...
 ...d equitable development involving , **inter alia** , access to productive resources , ...
 ...ertain products which could be used **inter alia** , as equipment on board ships but w...
 ...nexes , taking into consideration , **inter alia** , available scientific , technical ...
 ...w that it is absolutely necessary , **inter alia** , because of enlargement , to find ...
 ...paragraphs 1 and 2 as appropriate , **inter alia** , by conducting studies and compili...
 ...liability and efficiency , caused , **inter alia** , by insufficient technical and adm...
 ...in the Programme shall be pursued , **inter alia** , by the following means :

...get de l' Union , ce qui passe **notamment** par la résolution du problème de r...
 ...es États membres , la Commission a **notamment** arrêté la décision 2003 / 526 / C...
 ... durable et équitable , impliquant **notamment** l' accès aux ressources produc...
 ...susceptibles d' être utilisés **notamment** comme équipements mis à bord , mai...
 ...ion et à ses annexes , compte tenu **notamment** des informations scientifiques , tec...
 ...os ; il est absolument nécessaire , **notamment** en raison de l' élargissement ...
 ...ragraphes 1 et 2 le cas échéant , **notamment** en menant des études et en compilan...
 ... et d' efficacité en raison , **notamment** , d' une interopérabilité tec...
 ...nis dans le programme , il convient **notamment** de mettre en oeuvre les moyens ci @-...

translation of input phrase in training data context

Analysis: Alignment

diesmal	der Grund	lag	für den	Einbruch	an der	Wall	Street	.
52]	This time	was	the reason	for the	collapse	on Wall	Street	.

Phrase alignment of the decoding process
(red border, interactive)

Analysis: Tree Alignment

[#5] 4 . the following is to be substituted for the introductory section of Article 11 (1) :

[0.4787] 4 . Pour la partie introductive de l'article 11 , paragraphe 1 , est remplacé par le texte suivant :

Uses nested boxes to indicate tree structure
(red border, yellow shaded spans in focus, interactive)
for syntax model, non-terminals are also shown

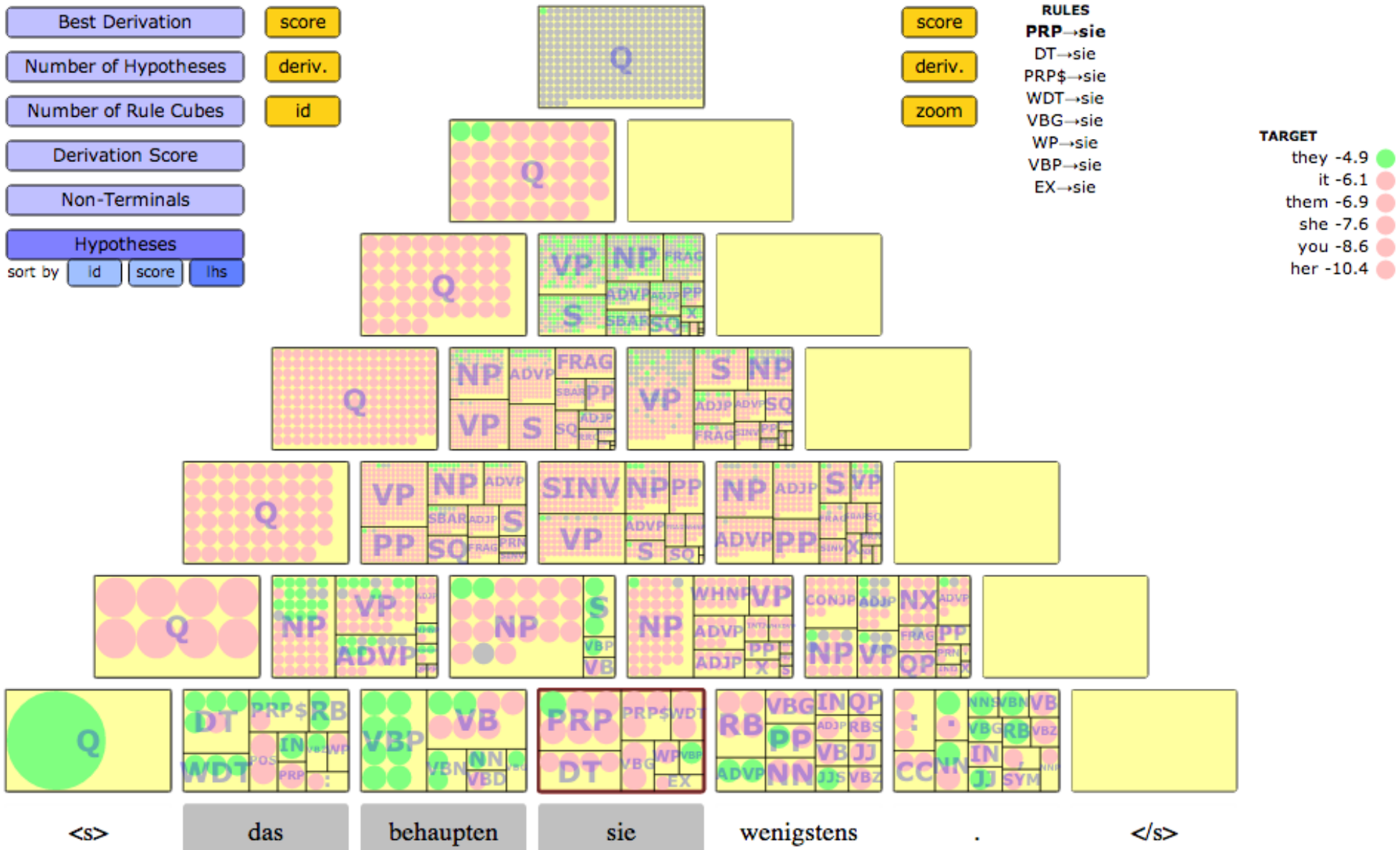

Analysis: Comparison of 2 Runs

annotated sentences

sorted by [order](#) order [worse](#) display [fullscreen](#) showing 5 [more](#) [all](#)

identical same better worse

2348 51 57 69

93% 2% 2% 3%

[2143:0.2974] In Austria , Haider and Co. are ready to govern to prevent a red and black coalition .

[2143:0.1754] In Austria , Haider and Co. are prepared to rule to prevent a red and black coalition .

[ref] Haider and his party are ready to govern Austria in order to avoid red @-@ black coalition .

[2165:0.3174] The SPÖ wants to show that the cooperation of both parties is possible - in some countries and in the social partnership that is already the case .

[2165:0.2061] The SPÖ wants to show that a cooperation of both parties is possible - in some countries and in the social partnership that is already the case .

[ref] SPÖ would like to show that the cooperation of the two parties is possible - it does exist in some of the provinces as well as in social partnership .

Different words are highlighted
sortable by most improvement, deterioration

Hands-On Session

Advanced Features



- How do I get started?
- Experiment Management System
- **Faster Training**
- Faster Decoding
- Moses Server
- Data and domain adaptation
- Instructions to decoder
- Input formats
- Output formats
- Translation models

Advanced Features

- How do I get started?
- Experiment Management System
- **Faster Training**
 - Tokenization
 - Tuning
 - Alignment
 - Phrase-Table Extraction
 - Train language model

...

Faster Training

- Run steps in parallel (that do not depend on each other)
- Multicore Parallelization

```
.../train-model.perl -parallel
```

- EMS:

```
[TRAINING]  
parallel = yes
```

Advanced Features



- How do I get started?
- Experiment Management System
- Faster Training
 - **Tokenization**
 - Tuning
 - Alignment
 - Phrase-Table Extraction
 - Train language model

...

Faster Training

- Multi-threaded tokenization
- Specify number of threads

```
.../tokenizer.perl -threads NUM
```

- EMS:

```
input-tokenizer = "$moses-script-dir/tokenizer/tokenizer.perl  
-threads NUM "
```

Advanced Features



- How do I get started?
- Experiment Management System
- Faster Training
 - Tokenization
 - **Tuning**
 - Alignment
 - Phrase-Table Extraction
 - Train language model

...

Faster Training



- Multi-threaded tokenization
- Specify number of threads

```
.../mert -threads NUM
```

- EMS:

```
tuning-settings = "-threads NUM"
```

Advanced Features

- How do I get started?
- Experiment Management System
- Faster Training
 - Tokenization
 - Tuning
 - **Alignment**
 - Phrase-Table Extraction
 - Train language model

...

Faster Training

- Word Alignment
- Multi-threaded
 - Use MGIZA, not GIZA++

```
.../train-model.perl -mgiza -mgiza-cpus NUM
```

EMS:

```
training-options = " -mgiza -mgiza-cpus NUM "
```

- On: memory-limited machines
 - snt2cooc program requires 6GB+ memory
 - Reimplementation uses 10MB, but take longer to run

```
.../train-model.perl -snt2cooc snt2cooc.pl
```

EMS:

```
training-options = "-snt2cooc snt2cooc.pl"
```

Advanced Features

- How do I get started?
- Experiment Management System
- Faster Training
 - Tokenization
 - Tuning
 - Alignment
 - **Phrase-Table Extraction**
 - Train language model

...

Faster Training

- Phrase-Table Extraction
 - Split training data into NUM equal parts
 - Extract concurrently

```
.../train-model.perl -cores NUM
```

Faster Training



- Sorting
 - Rely heavily on Unix 'sort' command
 - may take 50%+ of translation model build time
 - Need to optimize for
 - * speed
 - * disk usage
 - Dependent on
 - * sort version
 - * Unix version
 - * available memory

Faster Training

- Plain sorted

```
sort < extract.txt > extract.sorted.txt
```

- Optimized for large server

```
sort --buffer-size 10G --parallel 5  
    --batch-size 253 --compress-program gzip ...
```

- Use 10GB of RAM — the more the better
- 5 CPUs — the more the better
- mergesort at most 253 files
- compress intermediate files — less disk i/o

- In Moses:

```
.../train-model.perl -sort-buffer-size 10G -sort-parallel 5  
    -sort-batch-size 253 -sort-compress gzip
```

Advanced Features

- How do I get started?
- Experiment Management System
- Faster Training
 - Tokenization
 - Tuning
 - Alignment
 - Phrase-Table Extraction
 - **Train language model**

...

IRSTLM: Training

- Developed by FBK-irst, Trento, Italy
- Specialized training for large corpora
 - parallelization
 - reduce memory usage
- Quantization of probabilities
 - reduces memory but lose accuracy
 - probability stored in 1 byte instead of 4 bytes

IRSTLM: Training

- Training:

```
build-lm.sh -i "gunzip -c corpus.gz" -n 3  
            -o train.irstlm.gz -k 10
```

- `-n 3` = n-gram order
- `-k 10` = split training procedure into 10 steps

- EMS:

```
irst-dir = [IRST path]  
lm-training = "$moses-script-dir/generic/trainlm-irst.perl  
              -cores NUM -irst-dir $irst-dir"
```

Advanced Features



- How do I get started?
- Experiment Management System
- Faster Training
- **Faster Decoding**
- Moses Server
- Data and domain adaptation
- Instructions to decoder
- Input formats
- Output formats
- Translation models

Advanced Features

- How do I get started?
- Experiment Management System
- Faster Training
- **Faster Decoding**
 - Multi-threading
 - Speed vs. Memory
 - Speed vs. Quality

...

Advanced Features

- How do I get started?
- Experiment Management System
- Faster Training
- Faster Decoding
 - **Multi-threading**
 - Speed vs. Memory
 - Speed vs. Quality

...

Fast Decoding

- Multi-threaded decoding

```
.../moses --threads NUM
```

- Easy speed-up

Advanced Features

- How do I get started?
- Experiment Management System
- Faster Training
- Faster Decoding
 - Multi-threading
 - **Speed vs. Memory**
 - Speed vs. Quality

...

Speed vs. Memory Use

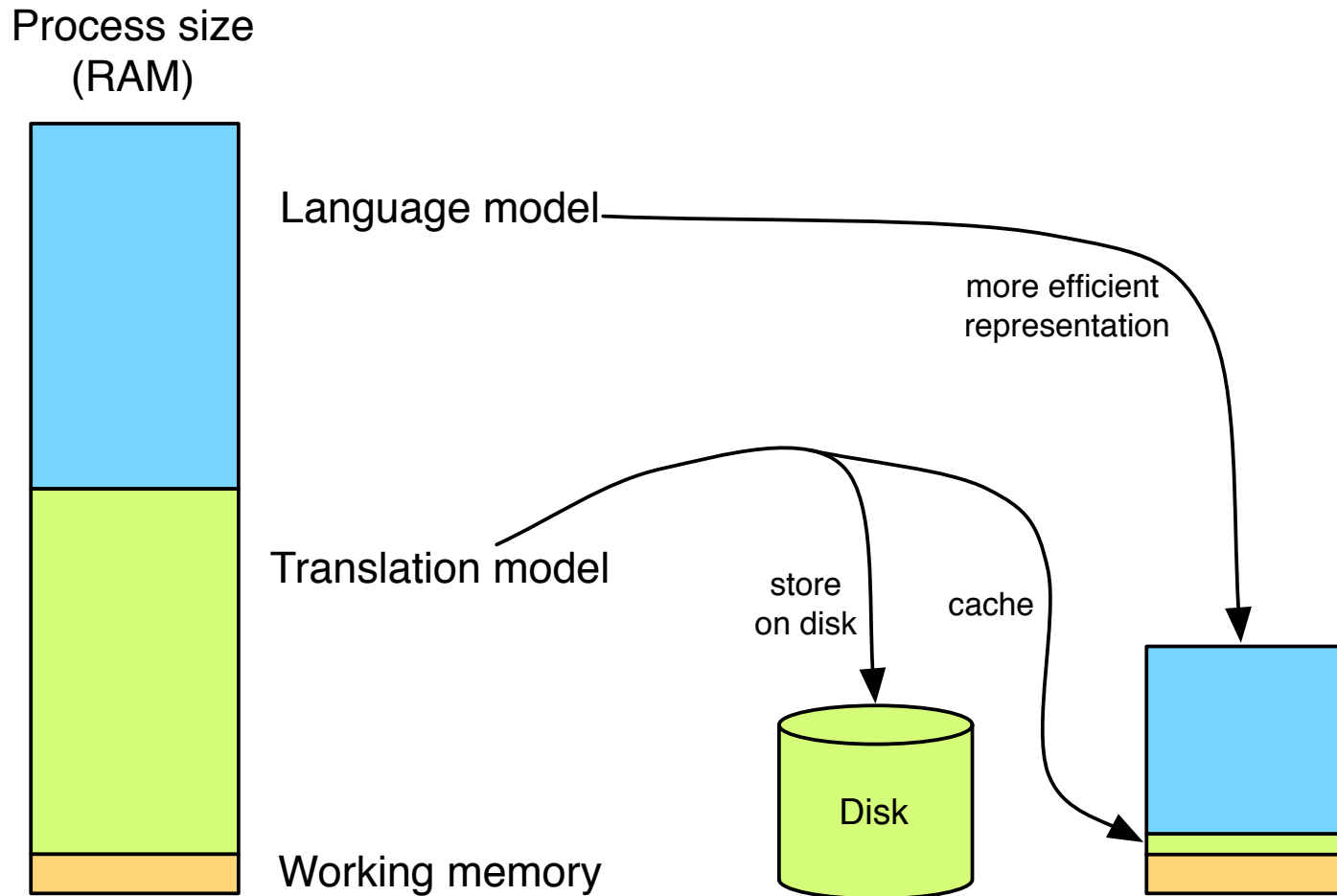

Speed vs. Memory Use

Typical Europarl file sizes:

- Language model
 - 170 MB (trigram)
 - 412 MB (5-gram)
- Phrase table
 - 11GB
- Lexicalized reordering
 - 9.4GB

→ total = 20.8 GB

Process size
(RAM)

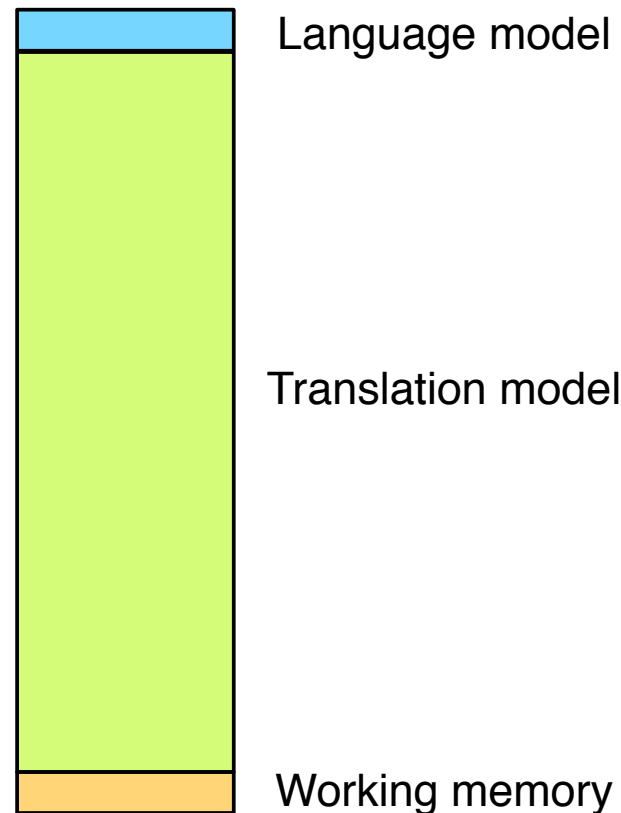

Speed vs. Memory Use

- Load into memory
 - long load time
 - large memory usage
 - fast decoding
- Load-on-demand
 - store indexed model on disk
 - binary format
 - minimal start-up time, memory usage
 - slower decoding

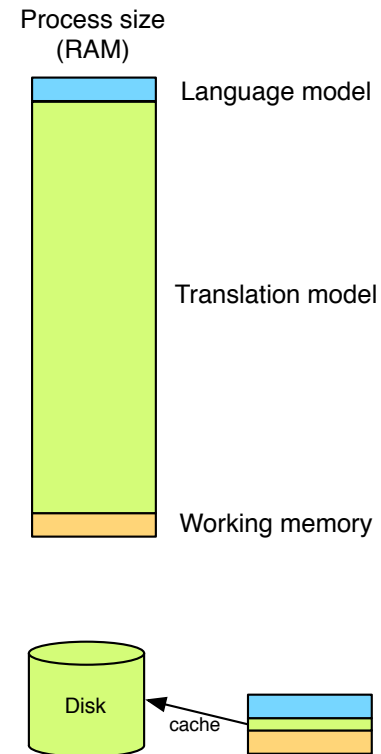

Speed vs. Memory Use

Phrase Table:

Phrase-based

```
export LC_ALL=C
cat pt.txt | sort | ./processPhraseTable -ttable 0 0 - \
-nscores 5 -out out.file
```

Hierarchical / Syntax

```
export LC_ALL=C
./CreateOnDiskPt 1 1 5 100 2 pt.txt out.folder
```

Lexical Reordering Table:

```
export LC_ALL=C
processLexicalTable -in r-t.txt -out out.file
```

Language Models (later)

Speed vs. Memory Use

Change ini file

Phrase-based

```
[ttable-file]  
1 0 0 5 out.file
```

Hierarchical / Syntax

```
[ttable-file]  
2 0 0 5 out.folder
```

Lexical Reordering Table

```
[distortion-file]  
0-0 wbe-msd-bidirectional-fe-allff 6 out.file
```

IRSTLM: Binary Format



- Create binary format:

```
compile-lm language-model.srilm language-model.blm
```

- Load-on-demand:

```
rename file .mm
```

IRSTLM in Moses



- Compile Moses with IRSTLM library

```
./bjam --with-irstlm=[root dir of the IRSTLM toolkit]
```

- Change ini file to use IRSTLM implementation

```
[lmodel-file]  
1 0 3 file/path
```

KenLM



- Another binary LM implementation
- Advantages:
 - Built into Moses. No need to compile separate library
 - Faster than IRSTLM and SRILM
 - Multi-threadable

- Create binary LM

```
build_binary lm.arpa lm.binlm
```

- Use in Moses

```
[lmodel-file]  
9 0 5 lm.binlm
```

Advanced Features

- How do I get started?
- Experiment Management System
- Faster Training
- Faster Decoding
 - Multi-threading
 - Speed vs. Memory
 - **Speed vs. Quality**

...

Speed vs. Quality

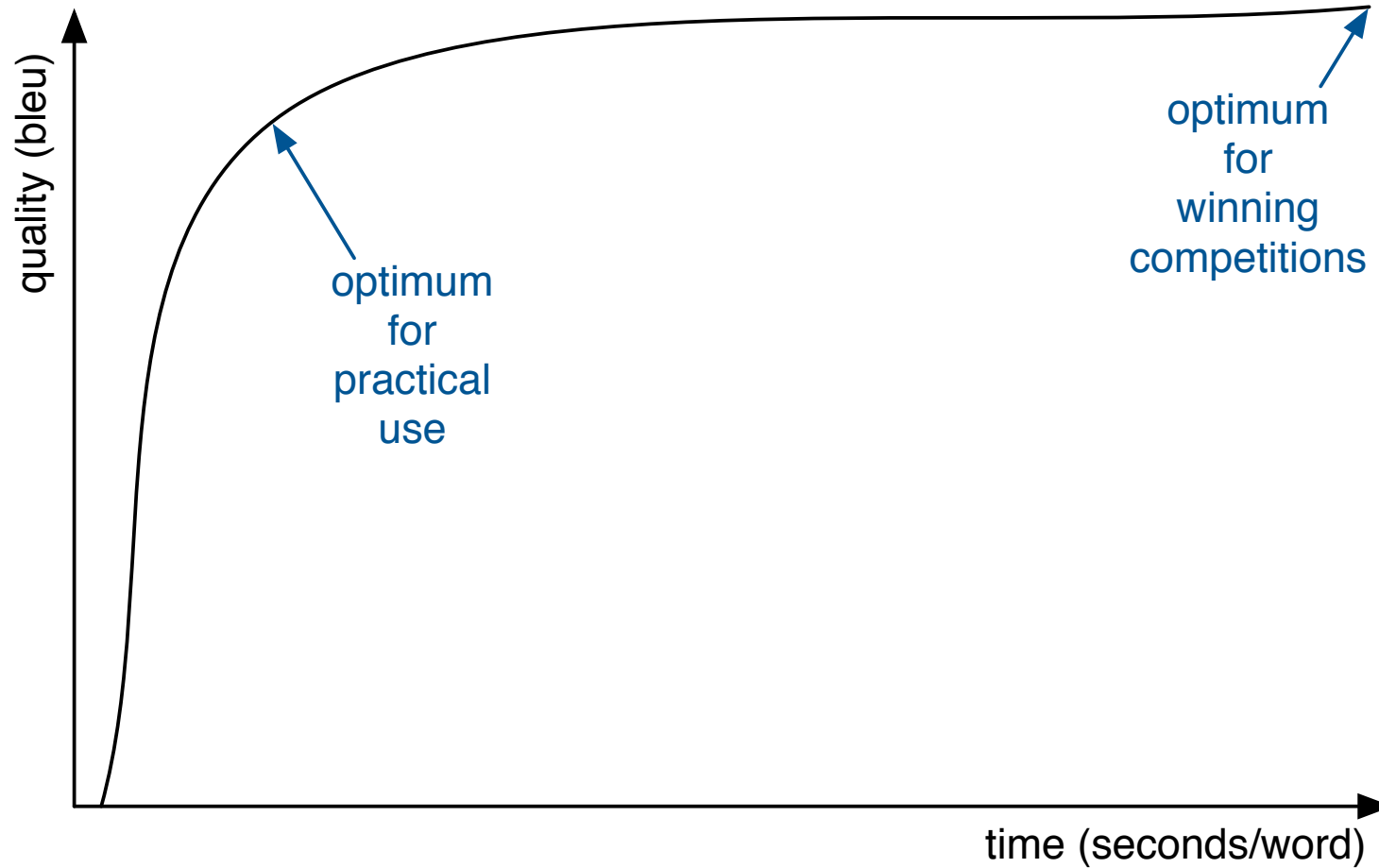

Speed vs. Quality

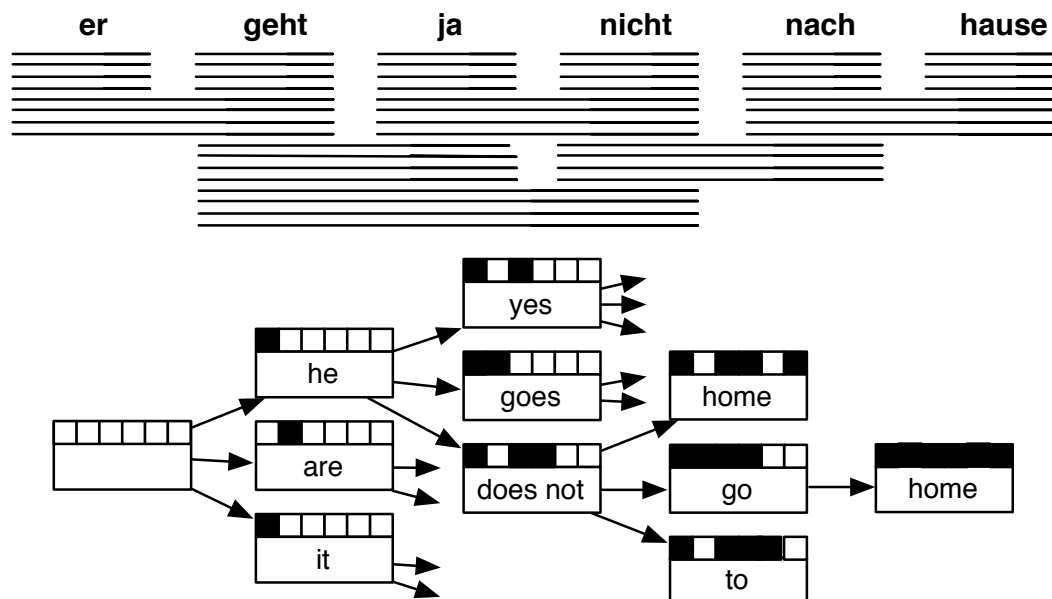

- Decoder search creates very large number of partial translations ("hypotheses")
- Decoding time \sim number of hypotheses created
- Translation quality \sim number of hypothesis created

Hypothesis Stacks

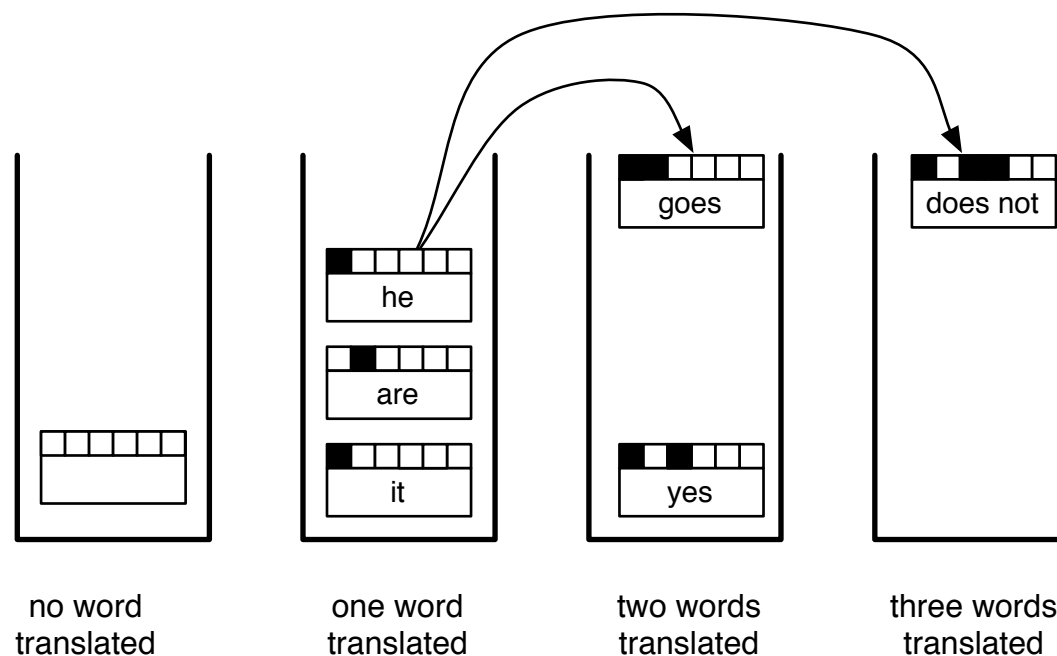

- Phrase-based: One stack per number of input words covered
- Number of hypothesis created =
sentence length \times stack size \times applicable translation options

Pruning Parameters

- Regular beam search
 - `--stack NUM` max. number of hypotheses contained in each stack
 - `--ttable-limit NUM` max. num. of translation options per input phrase
 - search time roughly linear with respect to each number
- Cube pruning
(fixed number of hypotheses are added to each stack)
 - `--search-algorithm 1` turns on cube pruning
 - `--cube-pruning-pop-limit NUM` number of hypotheses added to each stack
 - search time roughly linear with respect to pop limit
 - note: stack size and translation table limit have little impact in speed

Syntax Hypothesis Stacks

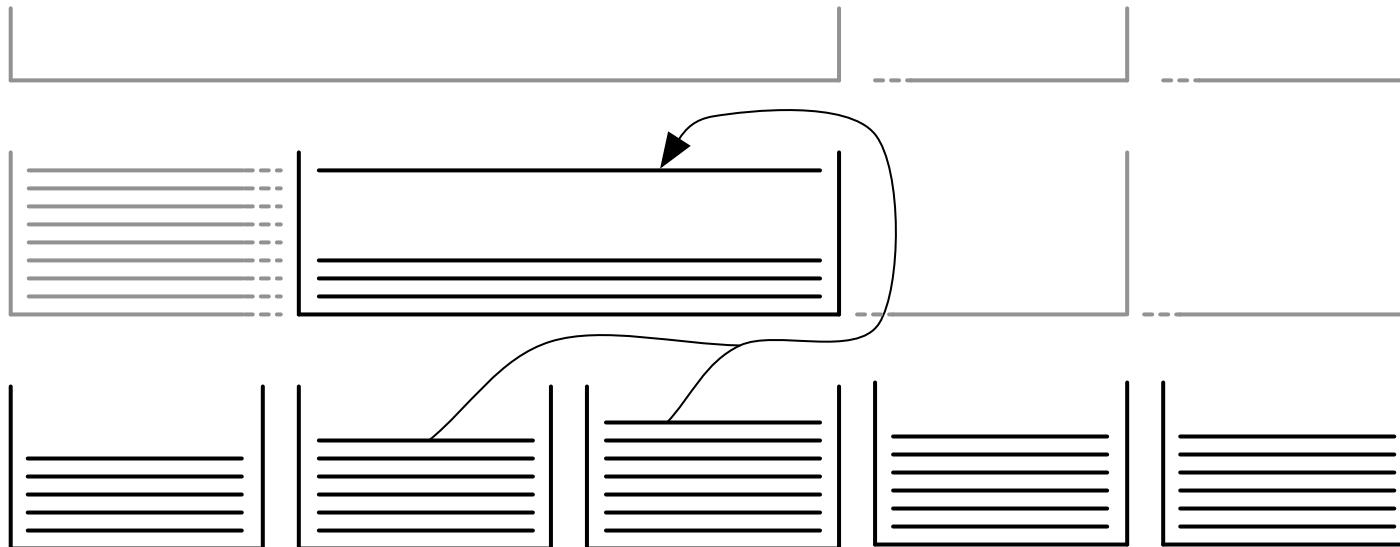

- One stack per input word span
- Number of hypothesis created =
sentence length² × number of hypotheses added to each stack
`--cube-pruning-pop-limit NUM` number of hypotheses added to each stack

Advanced Features



- How do I get started?
- Experiment Management System
- Faster Training
- Faster Decoding
- **Moses Server**
- Data and domain adaptation
- Instructions to decoder
- Input formats
- Output formats
- Translation models

Moses Server

- Moses command line:

```
.../moses -f [ini] < [input file] > [output file]
```

- Not practical for commercial use

- Moses Server:

```
.../mosesserver -f [ini] --server-port [PORT] --server-log [LOG]
```

- Accept HTTP input. XML SOAP format

- Client:

- Communicate via http
- Example clients in Java and Perl
- Write your own client
- Integrate into your own application

Advanced Features



- How do I get started?
- Experiment Management System
- Faster Training
- Faster Decoding
- Moses Server
- **Data and domain adaptation**
 - Train everything together
 - Secondary phrase table
 - Domain indicator features
 - Interpolated language models
 - TM-MT integration

Data



- Parallel corpora → translation model
 - sentence-aligned translated texts
 - translation memories are parallel corpora
 - dictionaries are parallel corpora
- Monolingual corpora → language model
 - text in the target language
 - billions of words easy to handle

Domain Adaptation

- The more data, the better
- The more in-domain data, the better
(even in-domain monolingual data very valuable)
- Multiple models
 - train a translation model for each domain corpus
 - train a language model for each domain corpus
 - use all, tune weights for each model
 - alternative: interpolate language model
- Always tune towards target domain

Domain Adaptation



- Retrain everything
- Secondary phrase table
- Domain indicator features
- Interpolated language models
- TM-MT integration

Advanced Features

- How do I get started?
- Experiment Management System
- Faster Training
- Faster Decoding
- Moses Server
- Data and domain adaptation
 - **Train everything together**
 - Secondary phrase table
 - Domain indicator features
 - Interpolated language models
 - TM-MT integration

Default: Train Everything Together



- Easy to implement
 - Concatenate new data with existing data
 - Retrain
- Disadvantages:
 - Slower training for large amount of data
 - Cannot weight old and new data separately

Default: Train Everything Together



Specification in EMS:

- Phrase-table

```
[CORPUS]
[CORPUS:in-domain]
raw-stem = ....
[CORPUS:background]
raw-stem = ....
```

- LM

```
[LM]
[LM:in-domain]
raw-corpus = ....
[LM:background]
raw-corpus = ....
```

Advanced Features

- How do I get started?
- Experiment Management System
- Faster Training
- Faster Decoding
- Moses Server
- Data and domain adaptation
 - Train everything together
 - **Secondary phrase table**
 - Domain indicator features
 - Interpolated language models
 - TM-MT integration

Secondary Phrase Table

- Train initial phrase table and LM on baseline data
- Train secondary phrase table and LM new/in-domain data
- Use both in Moses

```
[ttable-file]
1 0 0 5 .../path.1
1 0 0 5 .../path.2
```

```
[mapping]
0 T 0
1 T 1
```

– Secondary phrase table

Secondary Phrase Table

- – Secondary LM

```
[lmodel-file]
9 0 5 .../path.1
9 0 5 .../path.2
```

- Can give different weights for primary and secondary tables
- Not integrated into the EMS

Advanced Features

- How do I get started?
- Experiment Management System
- Faster Training
- Faster Decoding
- Moses Server
- Data and domain adaptation
 - Train everything together
 - Secondary phrase table
 - **Domain indicator features**
 - Interpolated language models
 - TM-MT integration

Domain Indicator Features



- One translation model
- Flag each phrase pair's origin
 - indicator: binary flag if it occurs in specific domain
 - ratio: how often it occurs in specific domain relative to all
 - subset: similar to indicator, but if in multiple domains, marked with multiple-domain feature
- In EMS:

```
[TRAINING]
domain-features = "indicator"
```

Advanced Features

- How do I get started?
- Experiment Management System
- Faster Training
- Faster Decoding
- Moses Server
- Data and domain adaptation
 - Train everything together
 - Secondary phrase table
 - Domain indicator features
 - **Interpolated language models**
 - TM-MT integration

Interpolated Language Models



- Train one language model per corpus
- Combine them by weighting each according to its importance
 - weights obtained by optimizing perplexity of resulting language model on tuning set (not the same as machine translation quality)
 - models are linearly combined
- EMS provides a section [INTERPOLATED-LM] that needs to be commented out
- Alternative: use multiple language models (disadvantage: larger process, slower)

Advanced Features



- How do I get started?
- Experiment Management System
- Faster Training
- Faster Decoding
- Moses Server
- Data and domain adaptation
 - Train everything together
 - Secondary phrase table
 - Domain indicator features
 - Interpolated language models
 - **TM-MT integration**

TM-MT Integration

- Input sentence:

The second paragraph of Article 21 is deleted .

- Fuzzy match in translation memory:

The second paragraph of Article 5 is deleted .

=

À l' article 5 , le texte du deuxième alinéa est supprimé .

Output word(s) taken from the target TM

Input word(s) that still need to be translated by SMT

TM-MT Integration

- Translation memory-style fuzzy match
 - For hierarchical decoding
 - Create long translation rule 'templates'
 - Best for use with parallel corpus with lots of repetition
- Add TM and word alignment as a special phrase table
 - Use in addition to normal phrase table

```
[ttable-file]
11 0 0 3 source-corpus;target-corpus;word-alignment
2 0 0 3 phrase table
6 0 0 3 glue-rules
```

Advanced Features



- How do I get started?
- Experiment Management System
- Faster Training
- Faster Decoding
- Moses Server
- Data and domain adaptation
- **Instructions to decoder**
- Input formats
- Output formats
- Translation models

Specifying Translations with XML

- Translation tables for numbers?

f	e	$p(f e)$
2003	2003	0.7432
2003	2000	0.0421
2003	year	0.0212
2003	the	0.0175
2003

- Instruct the decoder with XML instruction

the revenue for `<num translation="2003"> 2003 </num>` is higher than ...

- Deal with different number formats

er erzielte `<num translation="17.55"> 17,55 </num>` Punkte .

Walls and Zones

- Specification of reordering constraints
- Zone
sequence to be translated without reordering with outside material
- Wall
hard reordering constraint, no words may be reordered across
- Local wall
wall within a zone, not valid outside zone

Walls and Zones: Examples

- Requiring the translation of quoted material as a block

He said <zone> " yes " </zone> .

- Hard reordering constraint

Number 1 : <wall/> the beginning .

- Local hard reordering constraint within zone

A new plan <zone> (<wall/> maybe not new <wall/>) </zone> emerged .

- Nesting

The <zone> " new <zone> (old) </zone> " </zone> proposal .

Preserving Markup

- How do you translate this:

`<h1>My Home Page</h1>`
I really like to `eat` chicken!

- Solution 1: XML translations, walls and zones

```
<x translation="<h1>" /> <wall/> My Home Page <wall/>  
<x translation="</h1>" />
```

```
I really like to <zone><x translation="<b>" /> <wall/> eat <wall/>  
<x translation="</b>" /> </zone> chicken !
```

(note: special XML characters like `<` and `>` need to be escaped)

Preserving Markup

- Solution 2: Handle markup externally

- track word positions and their markup

I	really	like	to	eat	chicken	!
1	2	3	4	5	6	7
-	-	-	-		-	-

- translate without markup

I really like to eat chicken !

- keep word alignment to source

Ich	esse	wirklich	gerne	Hühnchen	!
1	5	2	3-4	6	7

- re-insert markup

Ich esse wirklich gerne Hühnchen!

Advanced Features



- How do I get started?
- Experiment Management System
- Faster Training
- Faster Decoding
- Moses Server
- Data and domain adaptation
- Instructions to decoder
- **Input formats**
- Output formats
- Translation models

Example: Misspelt Words

- Misspelt sentence:

The room was *excellent but the hallway was *filty .

- Strategies for dealing with spelling errors:
 - Create correct sentence with correction
 - ✗ problem: if not corrected properly, adds more errors
 - Create many sentences with different corrections
 - ✗ problem: have to decode each sentence, slow

Confusion Network

The room was *excellent but the hallway was *filthy .

Input to decoder:

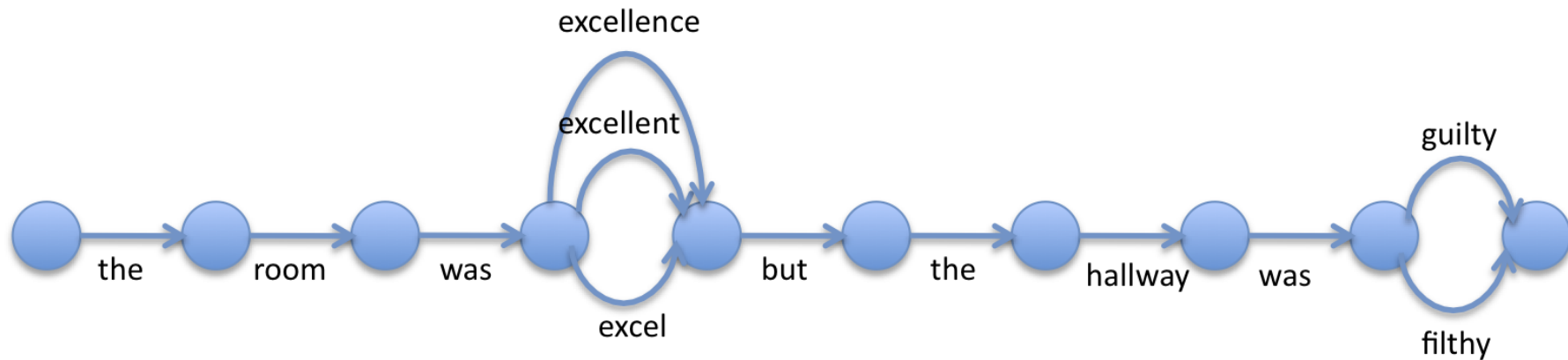

Let the decoder decide

Example: Diacritics

- Correct sentence

Trung Quốc cảnh báo Mỹ về luật tiền tệ

- Something a non-native person might type

Trung Quoc canh bao My ve luat tien te

- Confusion network

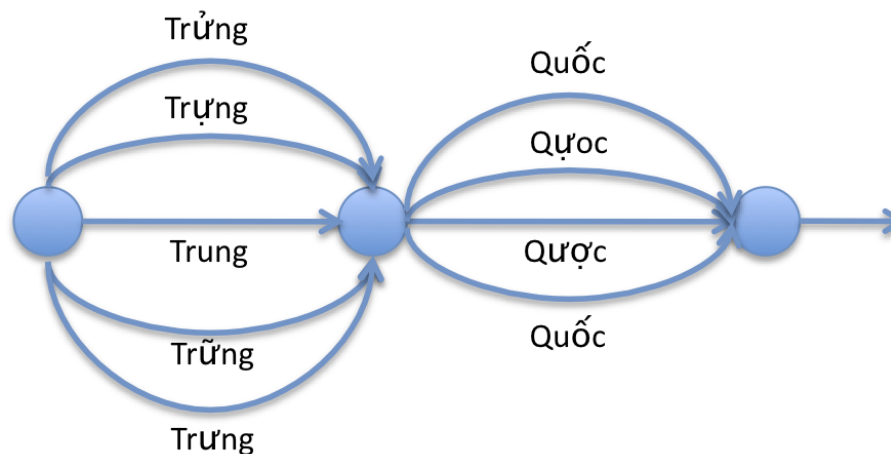

Confusion Network Specification

Argument on command line

```
./moses -inputtype 1
```

Input to moses

```
the 1.0  
room 1.0  
was 1.0  
excel 0.33 excellent 0.33 excellence 0.33  
but 1.0  
the 1.0  
hallway 1.0  
was 1.0  
guilty 0.5 filthy 0.5
```

Lattice

Example: Chinese Word Segmentation

- Unsegmented sentence

硬质合金号称"工业牙齿"

- Incorrect segmentation

硬质 合金 号称 " 工业 牙齿 "

- Correct segmentation

硬 质 合金 号称 " 工业 牙齿 "

Lattice

Input to decoder:

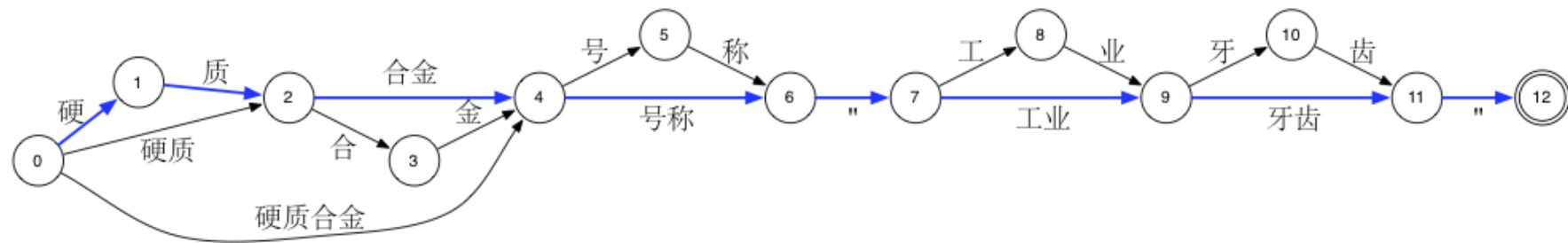

Let the decoder decide

Example: Compound Splitting

- Input sentence

einen wettbewerbsbedingten preissturz

- Different compound splits

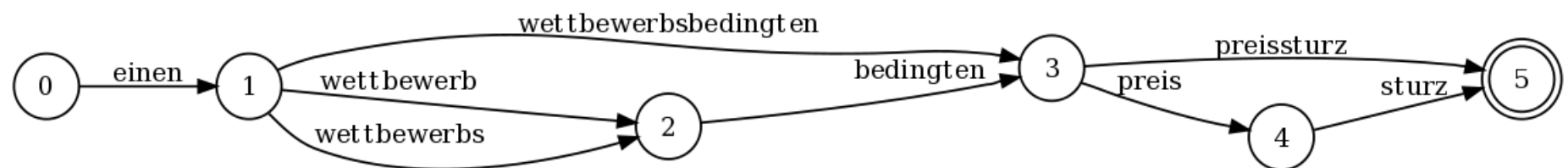

- Let the decoder decide

Lattice Specification

Command line argument

```
./moses -inputtype 1
```

Input to Moses (PLF format - Python Lattice Format)

```
(  
  (  
    ('einen', 1.0, 1),  
  ),  
  (  
    ('wettbewerbsbedingen', 0.5, 2),  
    ('wettbewerbs', 0.25, 1),  
    ('wettbewerb', 0.25, 1),  
  ),  
  (  
    ('bedingen', 1.0, 1),  
  ),  
  (  
    ('preissturz', 0.5, 2),  
    ('preis', 0.5, 1),  
  ),  
  (  
    ('sturz', 1.0, 1),  
  ),  
)
```

Advanced Features



- How do I get started?
- Experiment Management System
- Faster Training
- Faster Decoding
- Moses Server
- Data and domain adaptation
- Instructions to decoder
- Input formats
- **Output formats**
- Translation models

N-Best List

- Input

es gibt verschiedene andere meinungen .

- Best Translation

there are various different opinions .

- Next nine best translations

there are various other opinions .
there are different different opinions .
there are other different opinions .
we are various different opinions .
there are various other opinions of .
it is various different opinions .
there are different other opinions .
it is various other opinions .
it is a different opinions .

Uses of N-Best Lists

- Let the translator choose from possible translations
- Reranker
 - add more knowledge sources
 - can take global view
 - coherency of whole sentence
 - coherency of document
- Used to tune component weights

N-Best Lists in Moses

Argument to command line

```
./moses -n-bestlist n-best.file.txt [distinct] 100
```

Output

```
0 ||| there are various different opinions . ||| d: 0 lm: -21.6664 w: -6 ... ||| -113.734
0 ||| there are various other opinions . ||| d: 0 lm: -25.3276 w: -6 ... ||| -114.004
0 ||| there are different different opinions . ||| d: 0 lm: -27.8429 w: -6 ... ||| -117.738
0 ||| there are other different opinions . ||| d: -4 lm: -25.1666 w: -6 ... ||| -118.007
0 ||| we are various different opinions . ||| d: 0 lm: -28.1533 w: -6 ... ||| -118.142
0 ||| there are various other opinions of . ||| d: 0 lm: -33.7616 w: -7 ... ||| -118.153
0 ||| it is various different opinions . ||| d: 0 lm: -29.8191 w: -6 ... ||| -118.222
0 ||| there are different other opinions . ||| d: 0 lm: -30.426 w: -6 ... ||| -118.236
0 ||| it is various other opinions . ||| d: 0 lm: -32.6824 w: -6 ... ||| -118.395
0 ||| it is a different opinions . ||| d: 0 lm: -20.1611 w: -6 ... ||| -118.434
```

Search Graph

- Input

er geht ja nicht nach hause

- Return internal structure from the decoder

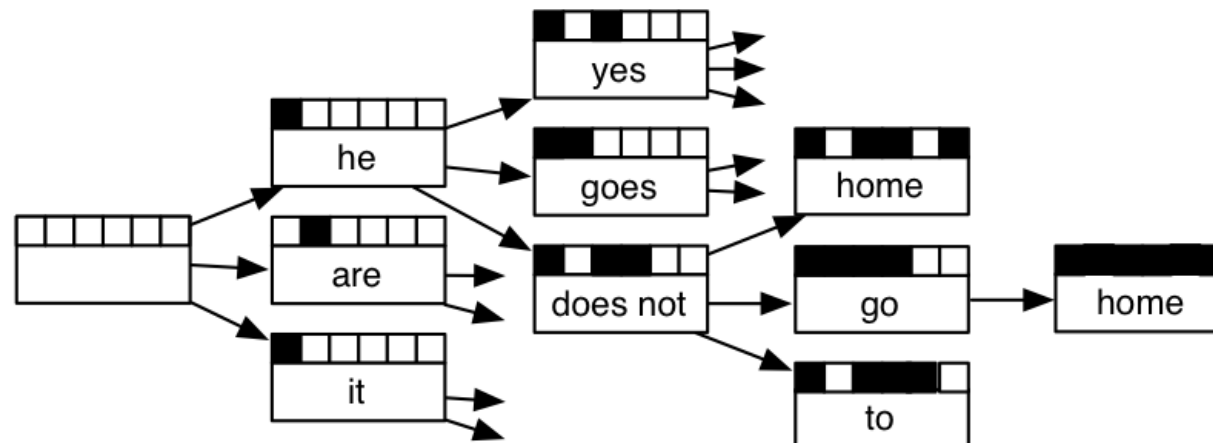

- Encode millions of other possible translations
(every path through the graph = 1 translation)



Uses of Search Graphs

- Let the translator choose
 - Individual words or phrases
 - 'Suggest' next phrase
- Reranker
- Used to tune component weights
 - More difficult than with n-best list

[1] **New probe into US attorney affair** >>
 Neuer Vorstoß in den USA Anwalt neue Affäre sonde (9 edits)

neue sonde

enter in

new	probe	into	US	attorney	affair
neue	Sonde	in	Anwalt	die	
die	testet	In	die	Staatsanwalt	Affäre
die	prüfen	In	In	Anwälte	die
der	Vorstoß	In	die	Testamentsvollstreckers	sie
eine	auszuforschen	In	die	Vollmachten	Angelegenheit
neuer	prüfen	auch	In	Anwalt	um
die	prüfen	In	der		Sache
das	prüfen	zu	amerikanische		haben
neu	prüfen	In	der		Geschichte
in		nach	die		das

Search Graphs in Moses

Argument to command line

```
./moses -output-search-graph search-graph.file.txt
```

Argument to command line

```
0 hyp=0 stack=0 forward=36 fscore=-113.734
0 hyp=75 stack=1 back=0 score=-104.943 ... covered=5-5 out=.
0 hyp=72 stack=1 back=0 score=-8.846 ... covered=4-4 out=opinions
0 hyp=73 stack=1 back=0 score=-10.661 ... covered=4-4 out=opinions of
```

- hyp - hypothesis id
- stack - how many words have been translated
- score - total weighted score
- covered - which words were translated by this hypothesis
- out - target phrase

Advanced Features



- How do I get started?
- Experiment Management System
- Faster Training
- Faster Decoding
- Moses Server
- Data and domain adaptation
- Instructions to decoder
- Input formats
- Output formats
- **Translation models**

Phrase-Based Model

- Advantages

- fast: under half a second per sentence for fast configuration
- low-memory requirement
 - * 200-300MB for lowest configuration
 - * suitable for netbooks and mobile devices
- outperform more complicated models for many language pairs
 - * especially for related languages pairs

- Command line

```
./moses -f moses.ini -i in.txt > out.txt
```

- Output

```
there are various different opinions .
```

Hierarchical Models

Advantages

- able to model non-contiguous phrases
 - ne..pas → not
- low-memory requirement
 - 200-300MB for lowest configuration
 - suitable for netbooks and mobile devices
- outperform phrase-based models when translating between widely different languages
 - Chinese-English consistently better with hierarchical model
 - better at medium range re-ordering
- Linguistically motivated

Disadvantages

- slower
 - 0.5 - 2 sec/sent. for fastest configuration
- more memory requirement
 - 1-2GB ram
- more disk usage
 - translation model ×10 larger than phrase-based

Command line `./moses_chart -f moses.ini -i in.txt > out.txt`

Syntax Models



- Hierarchical model + use of syntactic information (constituency parser, chunkers)
- Advantage
 - Can use outside linguistic information
 - promises to solve important problems in SMT, eg. long-range reordering
- Disadvantages
 - difficult to get right
 - for many language pairs still worse than phrase-based and hierarchical models
 - need syntactic parse information
 - * unreliable
 - * available only for some languages
 - * not designed for machine translation

Phrase-Based Model Training



- Command line

```
train-model.perl ...
```

- Model

```
Bndnisse ||| alliances ||| 1 1 1 1 2.718 ||| ||| 1 1  
General Musharraf betrat am ||| general Musharraf appeared on ||| 1 1 1 1 2.718 ||| ||| 1 1
```

Hierarchical Model

- Training

```
train-model.perl ... -hierarchical
```

- Decoding

```
./moses-chart -f moses.ini -i in.txt > out.txt
```

Hierarchical Model

- Example rule from model

```
Bündnisse [X][X] Kräften [X] ||| alliances [X][X] forces [X] ||| 1 1 1 1 2.718 ||| 1-1 ||| 0.0526316 0.0526316
```

- Visualization of rule

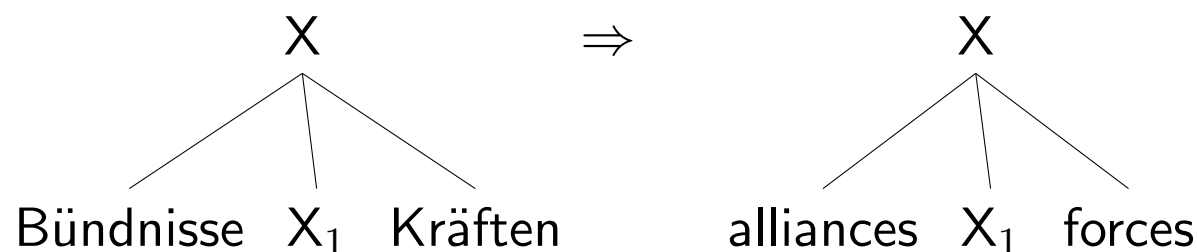

Hierarchical Model

Comparison with phrase-based model:

		Phrase-based	Hierarchical
BLEU (Europarl)	fr-en	25.10	24.58
	de-en	18.11	17.99
	es-en	25.81	25.17
	de-en	18.11	17.99
	cs-en	18.00	17.86
Phrase-table size	fr-en	2.5GB	20.0GB
Decoding time (sec)	per sentence	2.27	6.45
	per word	0.09	0.26

Things to look out for

- Sparse features
- Incremental model updating
- Confidence measures
- Open source computer aided translation



- Bigger, better, faster, more!

Acknowledgements

135



Moses Developers

136



Abhishek Arun
Amittai Axelrod
Barry Haddow
Christian Hardmeier
Edmund Huber
Frederic Blain
Hieu Hoang
Jean-Baptiste Fouet
Abby Levenberg
Mauro Cettolo
Mark Fishel
Nicola Bertoldi
Phil Williams
Joao Lus Rosas
Sara Stymne
Yizhao Ni
Suzy Howlett
Alexander Fraser

Adam Lopez
Ankit Srivastava
Ondrej Bojar
Christian Federmann
Evan Herbst
Brooke Cowan
H. Leal Fontes
Joern Wuebker
Alexandra Birch
Marcello Federico
Gabriele Antonio Musillo
Oliver Wilson
Bruno Pouliquen
Rico Sennrich
Steven B. Parks
David Kolovratnak
Wade Shen
Richard Zens

Ales Tamchyna
Anthony Rousseau
Chris Callison-Burch
Lane Schwartz
Andreas Eisele
Grace M. Ngai
Holger Schwenk
Jorge Civera
Bo Fu
Michael Auli
Miles Osborne
Pascual Martinez
Raphael Payen
Herve Saint-Amand
Steven Buraje Poggel
Sergio Penkale
Yang Gao

Alex
Benjamin Gottesman
Christine Corbett
David Talbot
Eva Hasler
Kenneth Heafield
Josh Schroeder
Konrad Rawlik
M.J.Bellino-Machado
John Joseph Morgan
Nadi Tomeh
Philipp Koehn
Chris Dyer
Felipe Sanchez Martinez
Andre Lynum
Stephan
Tsuyoshi Okita