

Large Scale QA-SRL Parsing

Nicholas FitzGerald, Julian Michael, Luheng He, and Luke Zettlemoyer

ACL 2018



<http://qasrl.org/>



Semantic Role Labelling

Subject

Manner

Verb

Object

Time

John surreptitiously ate the burrito at 2am.

Semantic Role Labelling

Subject

Manner

Verb

Object

Time

John surreptitiously ate the burrito at 2am.

- Applied to improve state-of-the-art in NLP tasks such as Question Answering [Shen 2007] and Machine Translation [Liu and Gildea, 2010]

Semantic Role Labelling

Subject

Manner

Verb

Object

Time

John surreptitiously ate the burrito at 2am.

- Applied to improve state-of-the-art in NLP tasks such as Question Answering [Shen 2007] and Machine Translation [Liu and Gildea, 2010]
- Commonly used interface to facilitate Data Exploration and Information Extraction [Stanovsky et al 2018] [Chiticariu et al. 2018]

Semantic Role Labelling

Subject

Manner

Verb

Object

Time

John surreptitiously ate the burrito at 2am.

- Applied to improve state-of-the-art in NLP tasks such as Question Answering [Shen 2007] and Machine Translation [Liu and Gildea, 2010]
- Commonly used interface to facilitate Data Exploration and Information Extraction [Stanovsky et al 2018] [Chiticariu et al. 2018]
- Considerable interest in general-purpose SRL parsers

QA-SRL

Subject

Manner

Verb

Object

Time

John surreptitiously ate the burrito at 2am.

Who ate something?

How was something eaten?

What was eaten?

When was something eaten?

QA-SRL

Subject

Manner

Verb

Object

Time

John surreptitiously ate the burrito at 2am.

Who ate something?

How was something eaten?

What was eaten?

When was something eaten?

QA-SRL 1.0

- Small dataset
- Trained annotators
- Only explored sub-problems

[He et al. 2015]

Goal

**A high-quality, large-scale
parser for QA-SRL**

In 1950 Alan M. Turing **published** "Computing machinery and intelligence" in Mind, in which he **proposed** that machines could be **tested** for intelligence **using** questions and answers.

published	When was something published?	In 1950
	Who published something?	Alan M. Turing
	What was published?	"Computing Machinery and Intelligence"
	Where was something published?	in Mind
proposed	When did someone propose something?	In 1950
	Who proposed something?	Alan M. Turing
	What did someone propose?	that machines could be tested for intelligent using questions and answers
	What did someone propose something in?	"Computing Machinery and Intelligence"
tested	What can be tested?	machines
	What can something be tested for?	intelligence
	How can something be tested?	using questions and answers
using	What was being used?	questions and answers
	Why was something being used?	tested for intelligence

Challenges

1. Scale up QA-SRL data annotation

Challenges

1. Scale up QA-SRL data annotation

Pierre Vinken, 61 years old, will **join** the board as a nonexecutive director Nov. 29.

Who will join something?
Pierre Vinken

Question about "join" (+5c)

What will someone join?
When will someone join something?
Where will someone join something?
Why will someone join something?

How
How long
How much
What
When
Where

In 1668 the king of Portugal **sent** an elephant from the kingdom of Congo to **the king of France**.

Invalid Where did someone send something? from the kingdom of Congo to the king of France

Invalid Where did someone send something from? the kingdom of Congo

Invalid **Who did someone send something to?**--> the king of France / Highlight to add an answer

Bonus: 4c

Challenges

1. Scale up QA-SRL data annotation

Pierre Vinken, 61 years old, will **join** the board as a nonexecutive director Nov. 29.

Who will join something?
Pierre Vinken

Question about "join" (+5c)

What will someone join?
When will someone join something?
Where will someone join something?
Why will someone join something?

How
How long
How much
What
When
Where

In 1668 the king of Portugal **sent** an elephant from the kingdom of Congo to **the king of France**.

Invalid Where did someone send something? from the kingdom of Congo to the king of France

Invalid Where did someone send something from? the kingdom of Congo

Invalid **Who did someone send something to?** --> the king of France / Highlight to add an answer

Bonus: 4c



**75k sentence
dataset in 9 days**

Challenges

1. Scale up QA-SRL data annotation
2. Train a QA-SRL Parser

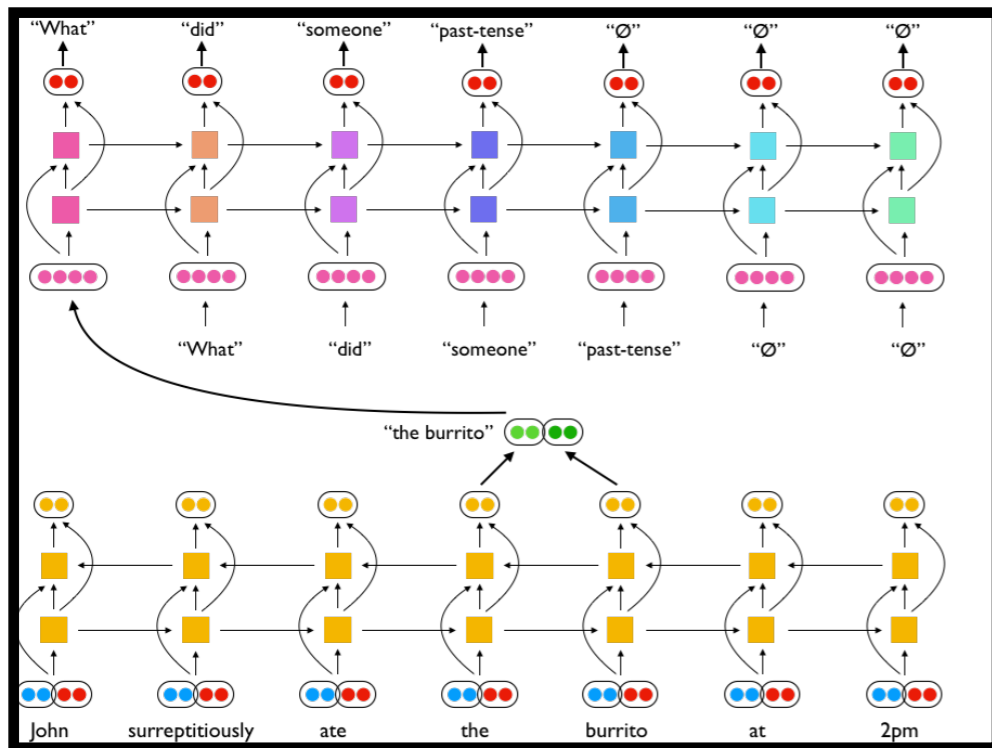

In the video, the perpetrators never appeared to look at the camera.

appeared	Where didn't someone appear to do something?	In the video
	Who didn't appear to do something?	the perpetrators
	When did someone appear?	never
	What didn't someone appear to do?	look at the camera to look at the camera
look	Where didn't someone look at something?	In the video
	Who didn't look?	the perpetrators
	What didn't someone look at?	the camera

Challenges

1. Scale up QA-SRL data annotation
2. Train a QA-SRL Parser
3. Improve Recall

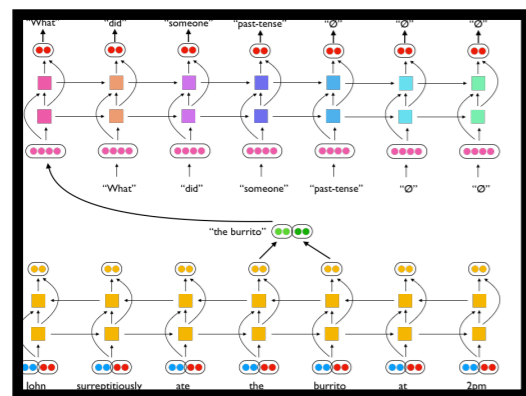

Overgenerate



Validate

**+11% data
+ 2% Fscore**

In 1950 Alan M. Turing **published** "Computing machinery and intelligence" in Mind, in which he **proposed** that machines could be **tested** for intelligence **using** questions and answers.

published	When was something published?	In 1950
	Who published something?	Alan M. Turing
	What was published?	"Computing Machinery and Intelligence"
	Where was something published?	in Mind
proposed	When did someone propose something?	In 1950
	Who proposed something?	Alan M. Turing
	What did someone propose?	that machines could be tested for intelligent using questions and answers
	What did someone propose something in?	"Computing Machinery and Intelligence"
tested	What can be tested?	machines
	What can something be tested for?	intelligence
	How can something be tested?	using questions and answers
using	What was being used?	questions and answers
	Why was something being used?	tested for intelligence

Large-scale QA-SRL Parsing

1. Scale up QA-SRL data annotation
2. Train a QA-SRL Parser
3. Improve Recall

Easier Annotation

UCCA [Abend and Rapaport 2013]	~6k sentences	4 Trained Annotators
Semantic Proto-roles [Reisinger et al. 2015]	~7k sentences	MTurk
Groningen Meaning Bank [Basile et al. 2012]	~40k sentences	Trained annotators/ GWAP
QASRL 1.0 [He et al. 2015]	~3k sentences	Trained annotators

QA-SRL

Questions:

Wh	Aux	Subj	Verb	Obj	Prep	Obj2
Who	∅	∅	∅	∅	∅	∅
What	did	someone	stem	someone	on	someone
Where	didn't	something	past	something	to	something
When	might		past participle		by	
Why	will		present		from	
How	

QA-SRL

John surreptitiously ate the burrito at 2am.

Questions:

Wh	Aux	Subj	Verb	Obj	Prep	Obj2
Who	∅	∅	∅	∅	∅	∅
What	did	someone	stem	someone	on	someone
Where	didn't	something	past	something	to	something
When	might		past participle		by	
Why	will		present		from	
How	

QA-SRL

John surreptitiously ate the burrito at 2am.

Questions:

Who ate something?

Wh	Aux	Subj	Verb	Obj	Prep	Obj2
Who	∅	∅	∅	∅	∅	∅
What	did	someone	stem	someone	on	someone
Where	didn't	something	past	something	to	something
When	might		past participle		by	
Why	will		present		from	
How	

QA-SRL

John surreptitiously ate the burrito at 2am.

Questions:

Who ate something?

What did someone eat?

Wh	Aux	Subj	Verb	Obj	Prep	Obj2
Who	∅	∅	∅	∅	∅	∅
What	did	someone	stem	someone	on	someone
Where	didn't	something	past	something	to	something
When	might		past participle		by	
Why	will		present		from	
How	

QA-SRL

John surreptitiously ate the burrito at 2am.

Questions:

Who ate something?

What did someone eat?

...

QA-SRL

John surreptitiously ate the burrito at 2am.

Questions:

Who ate something?

What did someone eat?

...

Answers:

John

QA-SRL

John surreptitiously ate the burrito at 2am.

Questions:

Who ate something?

What did someone eat?

...

Answers:

John

the burrito



Annotation Pipeline

x

John surreptitiously ate the burrito at 2am



Identify verbs with POS + heuristics

**Predicate
detection**

Annotation Pipeline

x

John surreptitiously ate the burrito at 2am



Identify verbs with POS + heuristics



One worker writes as many QA-SRL questions as possible,
and provides the answer

**Predicate
detection**

**Question
annotation**

Annotation Pipeline

x

John surreptitiously ate the burrito at 2am



Identify verbs with POS + heuristics



One worker writes as many QA-SRL questions as possible,
and provides the answer



2 workers are shows questions,
provide answers or mark as invalid

**Predicate
detection**

**Question
annotation**

Validation

Question Annotation

- Efficiency
- Recall

Question Annotation

- Efficiency
 - Autocomplete

Pierre Vinken, 61 years old, will [join](#) the board as a nonexecutive director Nov. 29.

Who will join|

Who will join as

Who will join by

Who will join do

Who will join doing

Who will join for

Who will join from

Who will join in

Who will join someone

Who will join something

Who will join somewhere

Who will join to

Who will join with

Question Annotation

- Efficiency
 - Autocomplete
- Recall
 - Autosuggest

Pierre Vinken, 61 years old, will [join](#) the board as a nonexecutive director Nov. 29.

Who will join something?

Pierre Vinken

Question about "join" (+5c)

What will someone join?

When will someone join something?

Where will someone join something?

Why will someone join something?

How

How long

How much

What

When

Where

Question Annotation

- Efficiency
 - Autocomplete
- Recall
 - Autosuggest
 - Financial Incentives

Validation Interface

In 1668 the king of Portugal sent an elephant from the kingdom of Congo to **the king of France**.

Invalid Where did someone send something? from the kingdom of Congo to the king of France

Invalid Where did someone send something from? the kingdom of Congo

Invalid **Who did someone send something to?** --> the king of France / Highlight to add an answer

Bonus: 4c

Dataset

- 1 annotator provides questions
- 2 annotators validate -> 3 spans / question
 - Question invalid if any annotator marks invalid
- Additional 3 validators for small dense dev and test set

Dataset

	Wikipedia	Wikinews	Science
Sentences	15,000	14,682	46,715
Verbs	32,758	34,026	66,653
Questions	75,867	80,081	143,388
Valid Qs	67,146	70,555	127,455

[He et al 2015]	This work
3000 sentences	75k sentences
Several weeks	9 days
~50c / verb	33c / verb
2.43 questions / verb	2.05 questions / verb

In 1950 Alan M. Turing **published** "Computing machinery and intelligence" in Mind, in which he **proposed** that machines could be **tested** for intelligence **using** questions and answers.

published	Who published something?	Alan M. Turing
	What was published?	"Computing Machinery and Intelligence"
	When was something published?	In 1950
	Where was something published?	in Mind
proposed	Who proposed something?	Alan M. Turing
	What did someone propose?	that machines could be tested for intelligent using questions and answers
	When did someone propose something?	In 1950
	What did someone propose something in?	"Computing Machinery and Intelligence"
tested	What can be tested?	machines
	What can something be tested for?	intelligence
	How can something be tested?	using questions and answers
using	What was being used?	questions and answers
	Why was something being used?	tested for intelligence

In 1950 Alan M. Turing **published** "Computing machinery and intelligence" in Mind, in which he **proposed** that machines could be **tested** for intelligence **using** questions and answers.

published	Who published something?	Alan M. Turing
	What was published?	"Computing Machinery and Intelligence"
	When was something published?	In 1950
	Where was something published?	in Mind
proposed	Who proposed something?	Alan M. Turing
	What did someone propose?	that machines could be tested for intelligent using questions and answers
	When did someone propose something?	In 1950
	What did someone propose something in?	"Computing Machinery and Intelligence"
tested	What can be tested?	machines
	What can something be tested for?	intelligence
	How can something be tested?	using questions and answers
using	What was being used?	questions and answers
	Why was something being used?	tested for intelligence

In 1950 Alan M. Turing **published** "Computing machinery and intelligence" in Mind, in which he **proposed** that machines could be **tested** for intelligence **using** questions and answers.

published	Who published something?	Alan M. Turing
	What was published?	"Computing Machinery and Intelligence"
	When was something published?	In 1950
	Where was something published?	in Mind
proposed	Who proposed something?	Alan M. Turing
	What did someone propose?	that machines could be tested for intelligent using questions and answers
	When did someone propose something?	In 1950
	What did someone propose something in?	"Computing Machinery and Intelligence"
tested	What can be tested?	machines
	What can something be tested for?	intelligence
	How can something be tested?	using questions and answers
using	What was being used?	questions and answers
	Why was something being used?	tested for intelligence

Large-scale QA-SRL Parsing

1. Scale up QA-SRL data annotation
- 2. Train a QA-SRL Parser**
3. Improve Recall

QA-SRL Parser

Span-Graph for SRL

[He et al 2018]

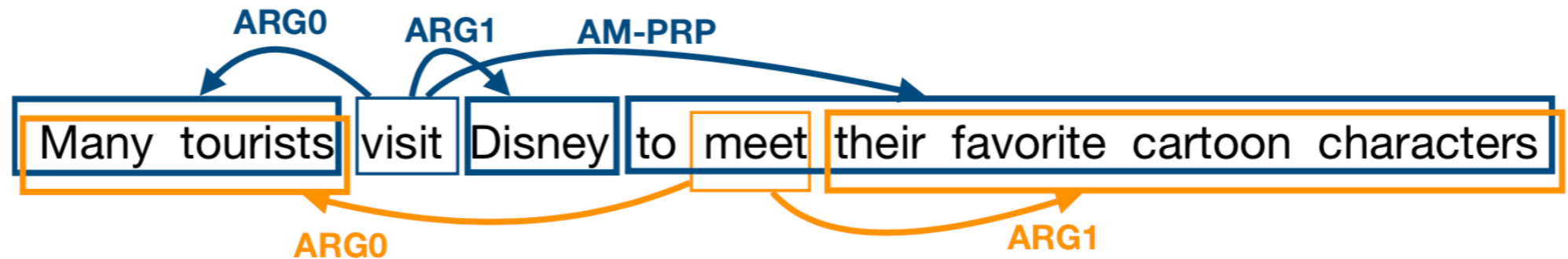

BIO-based Encoding for SRL

[He et al 2017]

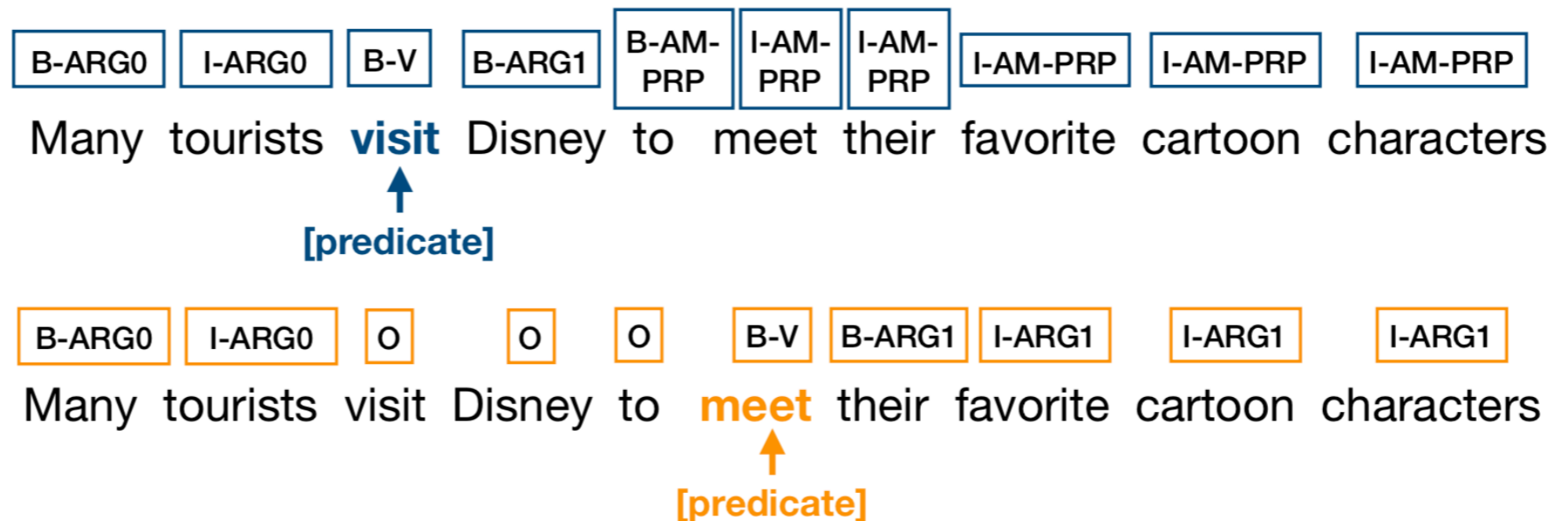

QA-SRL Parser

Span-Graph for SRL

[He et al 2018]

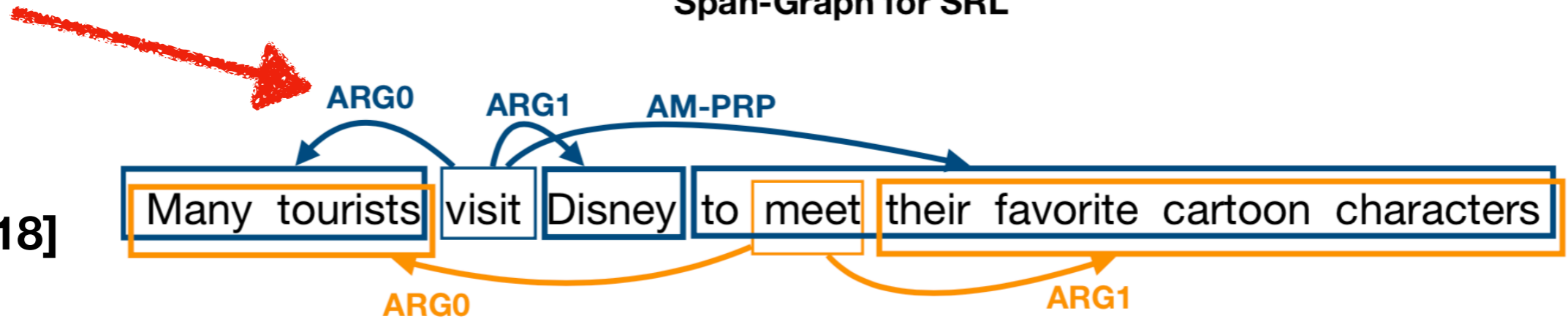

BIO-based Encoding for SRL

[He et al 2017]

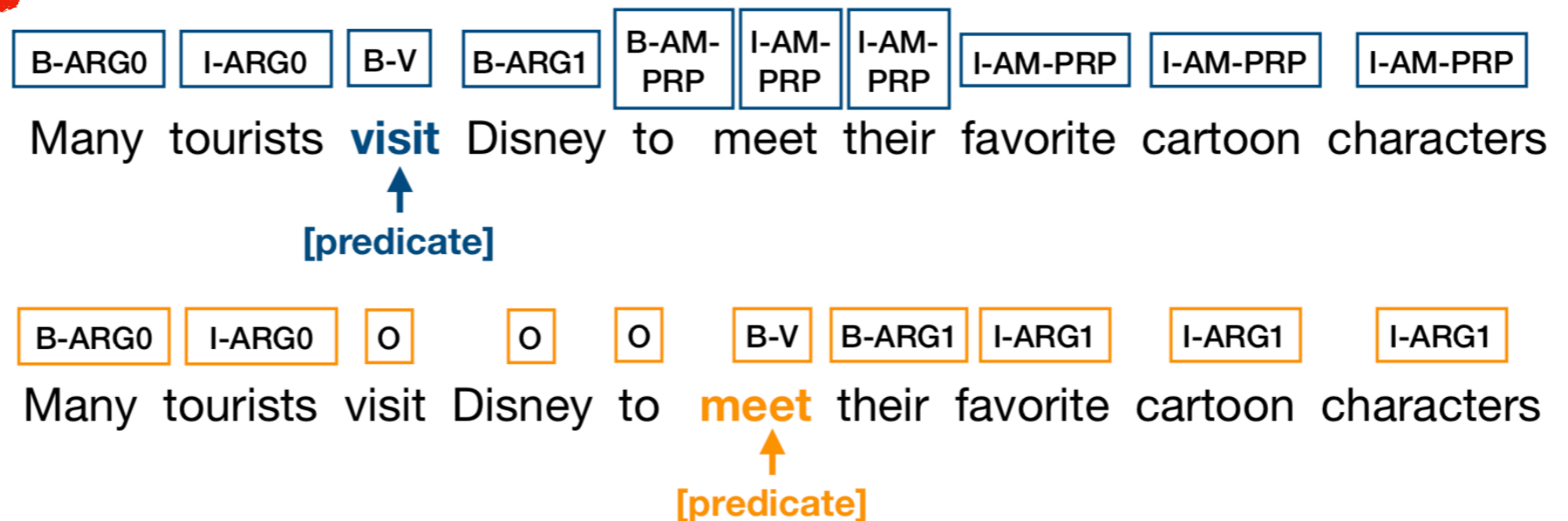

QA-SRL Parser

- Unlabeled Argument Detection
- Question generation

QA-SRL Parsing

x

John surreptitiously ate the burrito at 2pm

QA-SRL Parsing

x

John surreptitiously ate the burrito at 2pm



0 0 1 0 0 0 0

**Predicate
detection**

QA-SRL Parsing

x

John surreptitiously ate the burrito at 2pm



0 0 1 0 0 0 0

**Predicate
detection**

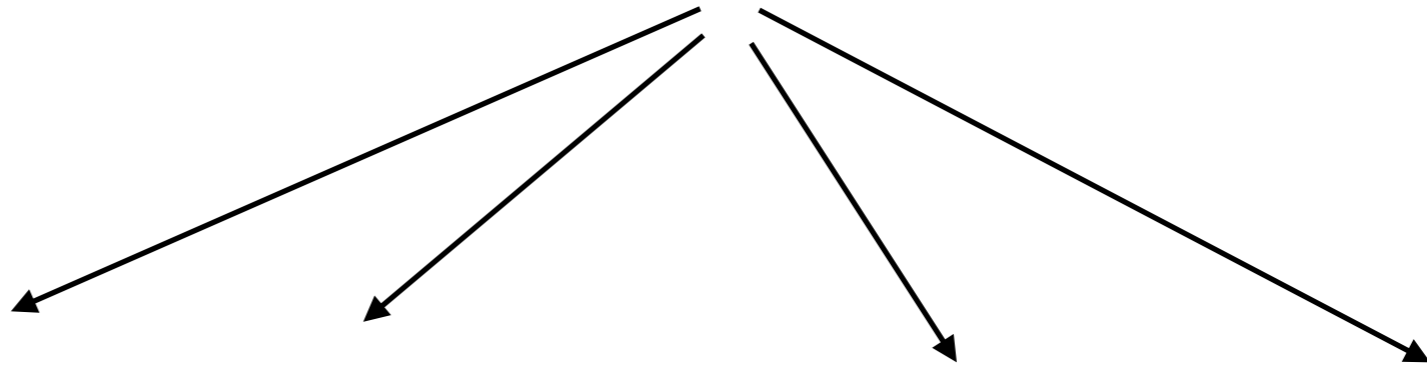

**Argument
detection**

“John”

“surreptitiously”

“the burrito”

“at 2pm”

QA-SRL Parsing

x

John surreptitiously ate the burrito at 2pm



0 0 1 0 0 0 0

**Predicate
detection**

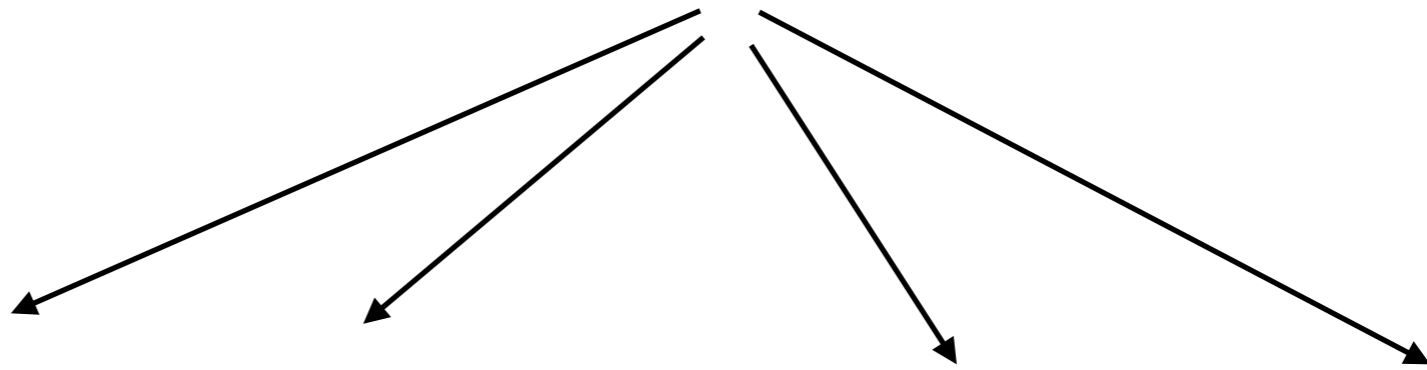

“John”

“surreptitiously”

“the burrito”

“at 2pm”

**Argument
detection**



“Who ate something?”

“How did someone
eat something?”

“What did someone
eat?”

“When did someone
eat something?”

**Question
generation**

QA-SRL Parsing

x

John surreptitiously ate the burrito at 2pm

**Predicate
detection**

Automatic Heuristics
(same as data)

0 0 1 0 0 0 0

**Argument
detection**

“John”

“surreptitiously”

“the burrito”

“at 2pm”

**Question
generation**

“Who ate something?”

“How did someone
eat something?”

“What did someone
eat?”

“When did someone
eat something?”

QA-SRL Parsing

x

John surreptitiously ate the burrito at 2pm

**Predicate
detection**

Automatic Heuristics
(same as data)

0 0 1 0 0 0 0

**Argument
detection**

1. BIO Model
2. Span-based Model

“surreptitiously”

“the burrito”

“at 2pm”

**Question
generation**

“Who ate something?”

“How did someone
eat something?”

“What did someone
eat?”

“When did someone
eat something?”

QA-SRL Parsing

x

John surreptitiously ate the burrito at 2pm

**Predicate
detection**

Automatic Heuristics
(same as data)

0 0 1 0 0 0 0

**Argument
detection**

1. BIO Model
2. Span-based Model

“surreptitiously”

“the burrito”

“at 2pm”

**Question
generation**

1. Local
2. Sequential

“How did someone
eat something?”

“What did someone
eat?”

“When did someone
eat something?”

Argument Detection - BIO Model

- Alternating Bi-LSTM with Highway Connections and Recurrent Dropout [He et al 2017]
- Input includes predicate indicator

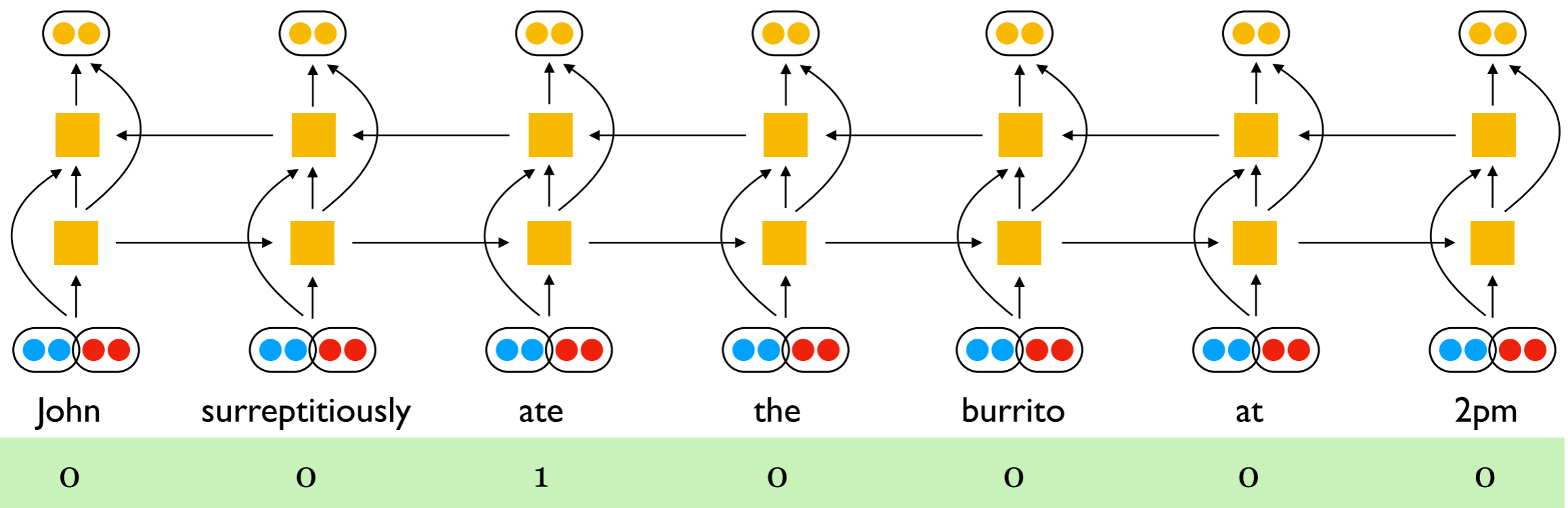

Argument Detection - BIO Model

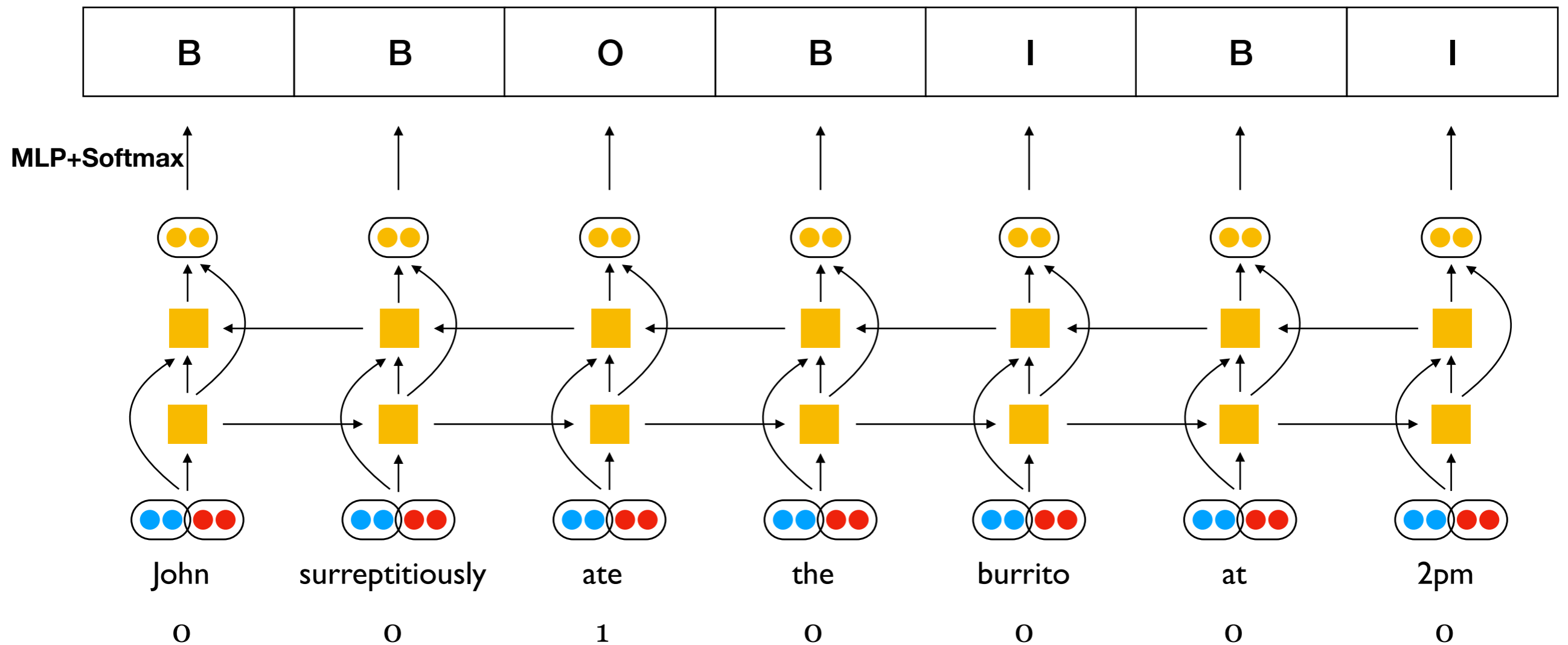

Argument Detection - BIO Model

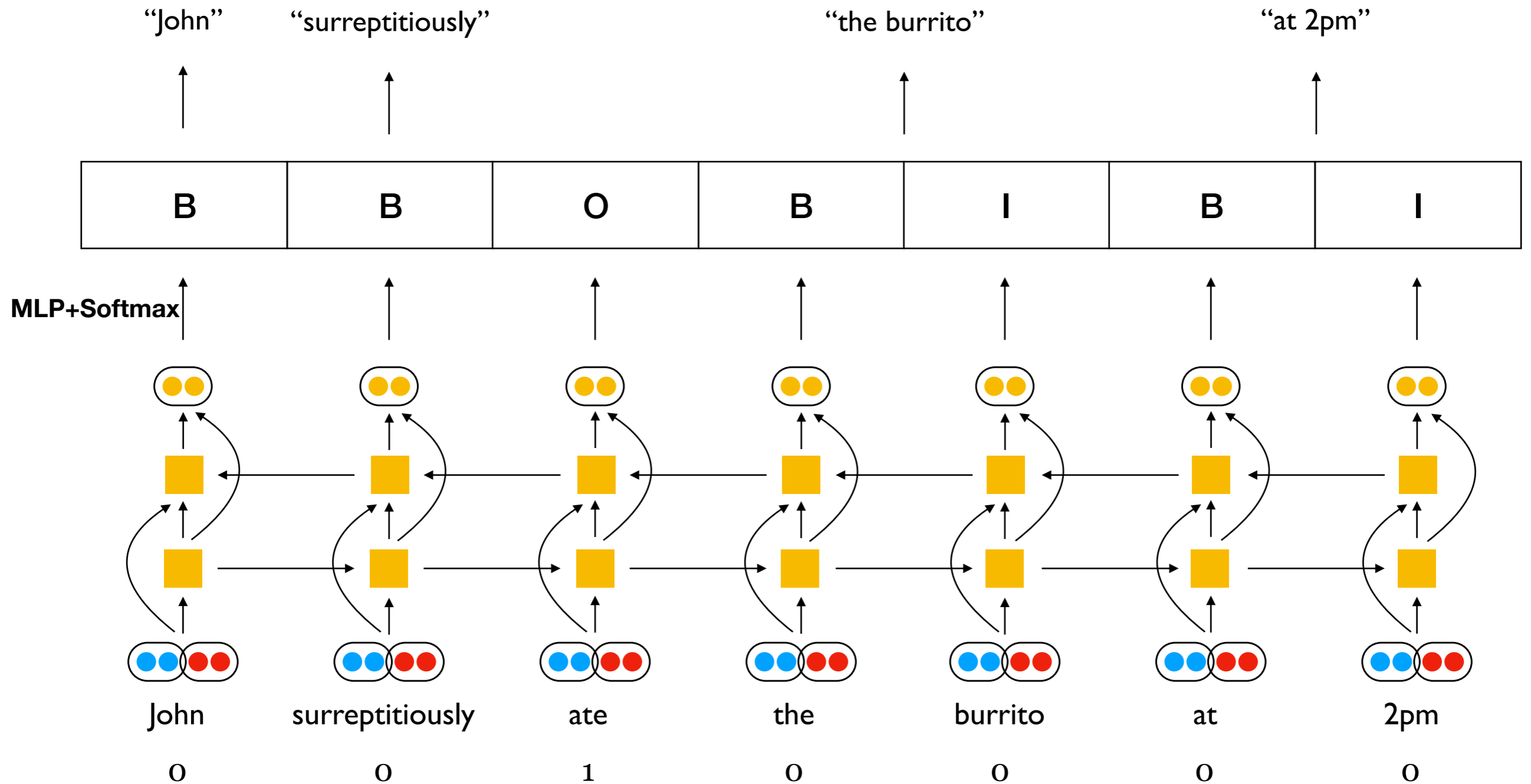

Argument Detection - Span Model

Form a representation of every possible span

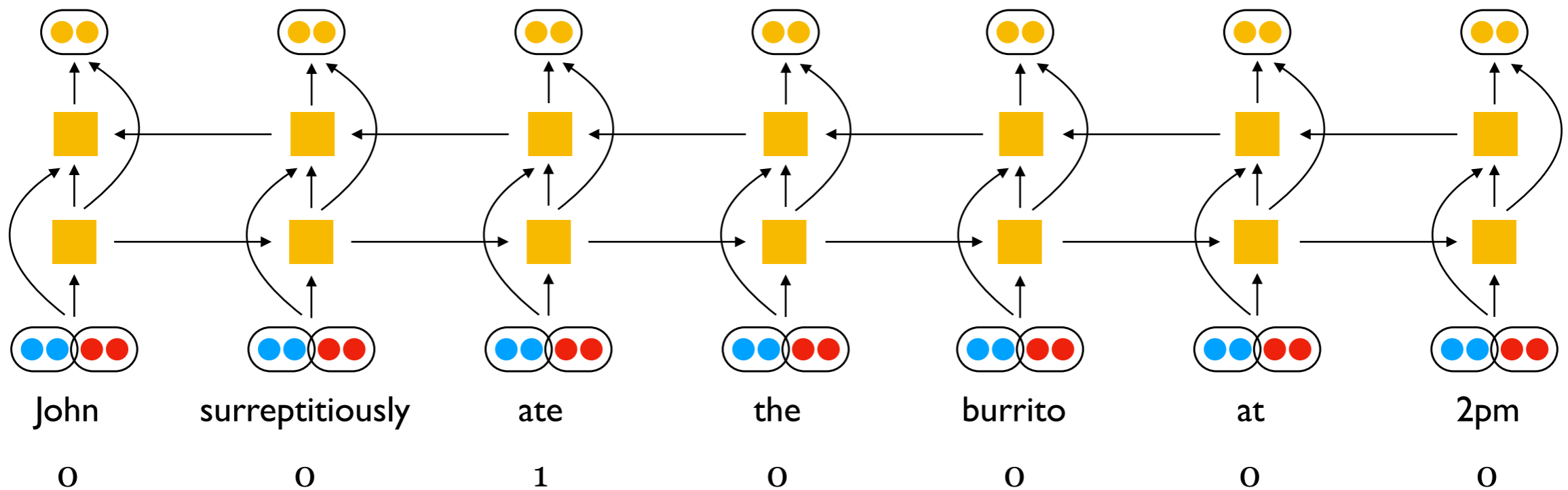

Argument Detection - Span Model

Form a representation of every possible span

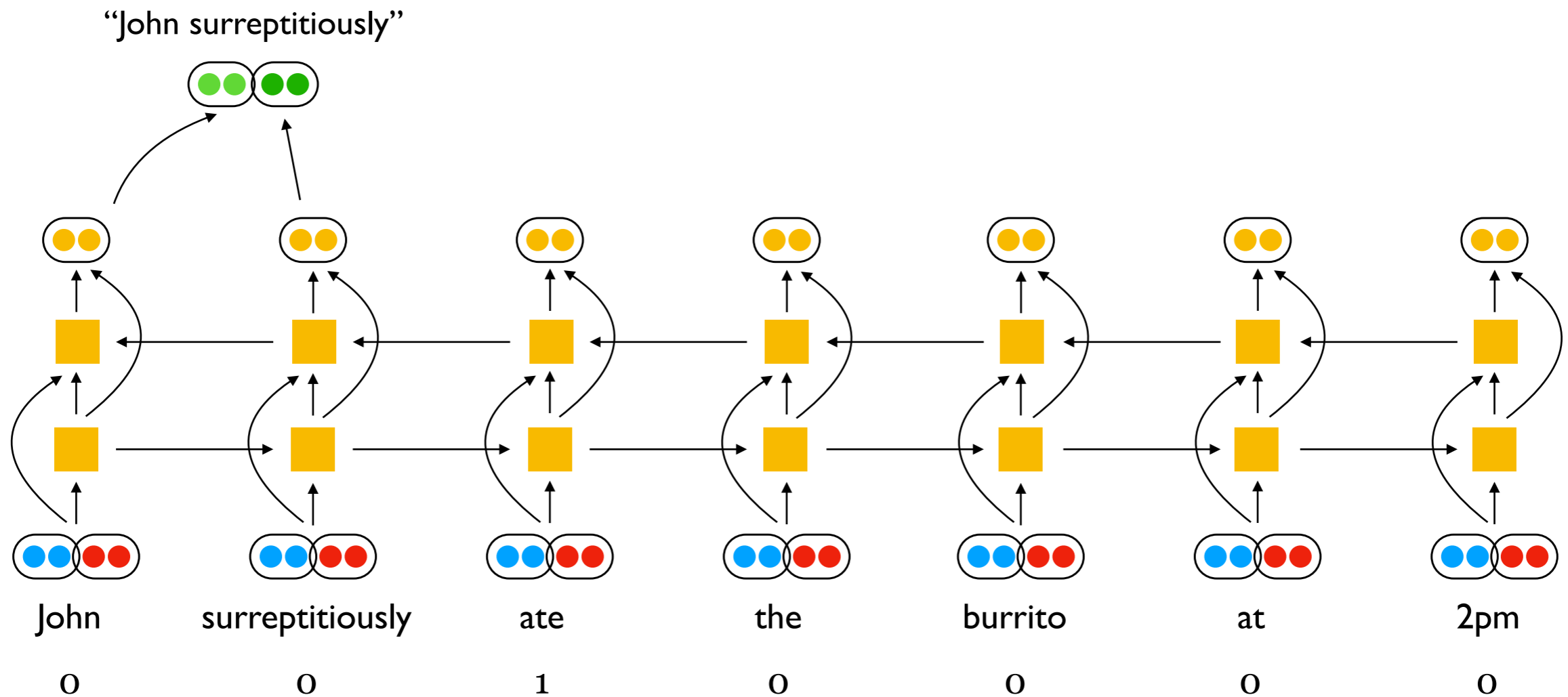

Argument Detection - Span Model

Form a representation of every possible span

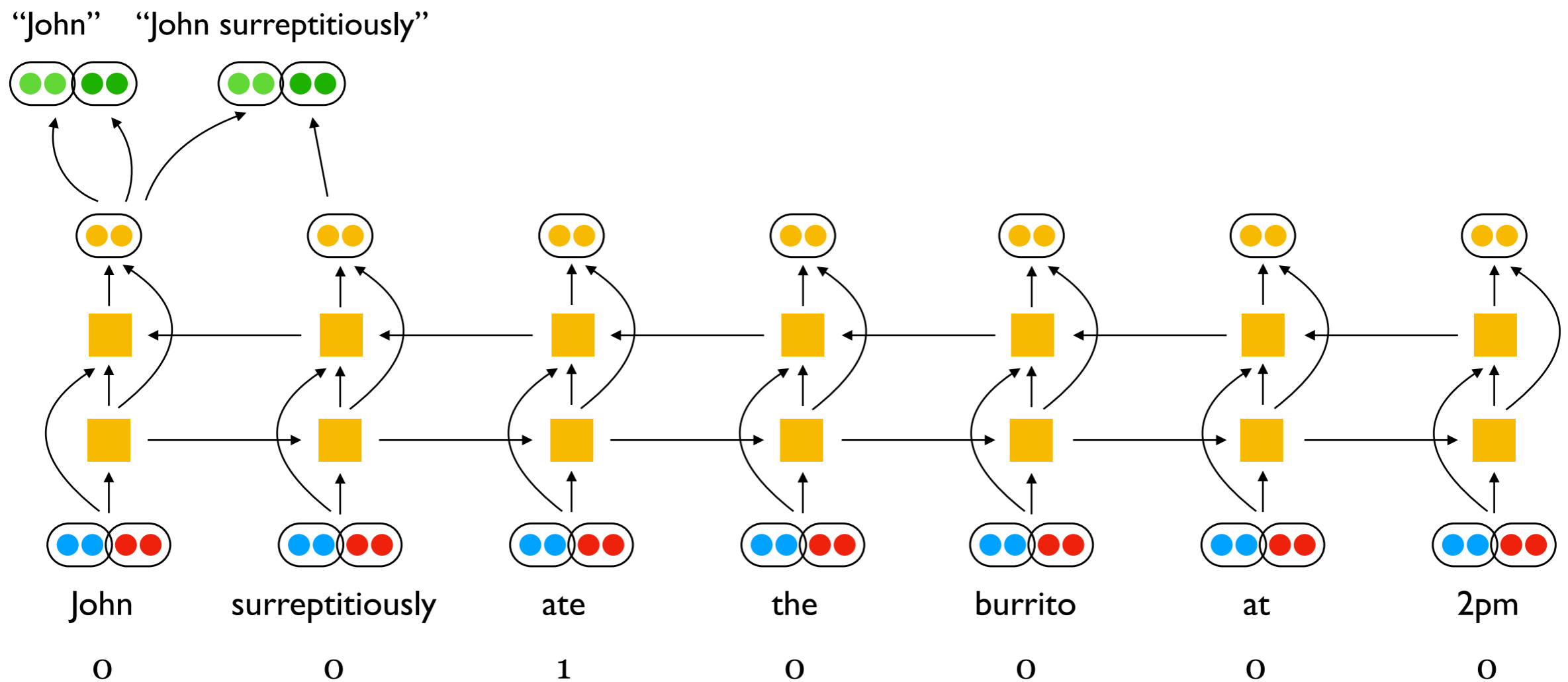

Argument Detection - Span Model

Form a representation of every possible span

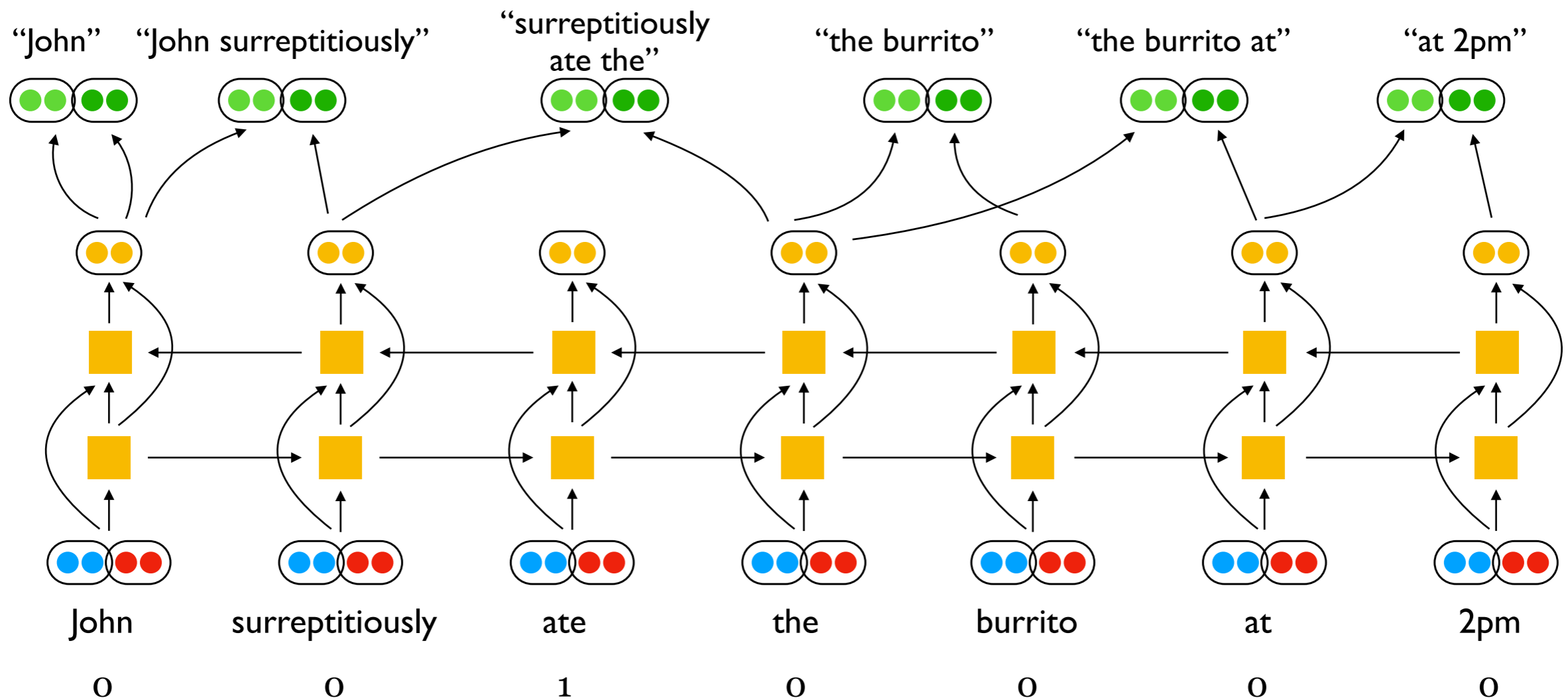

Argument Detection - Span Model

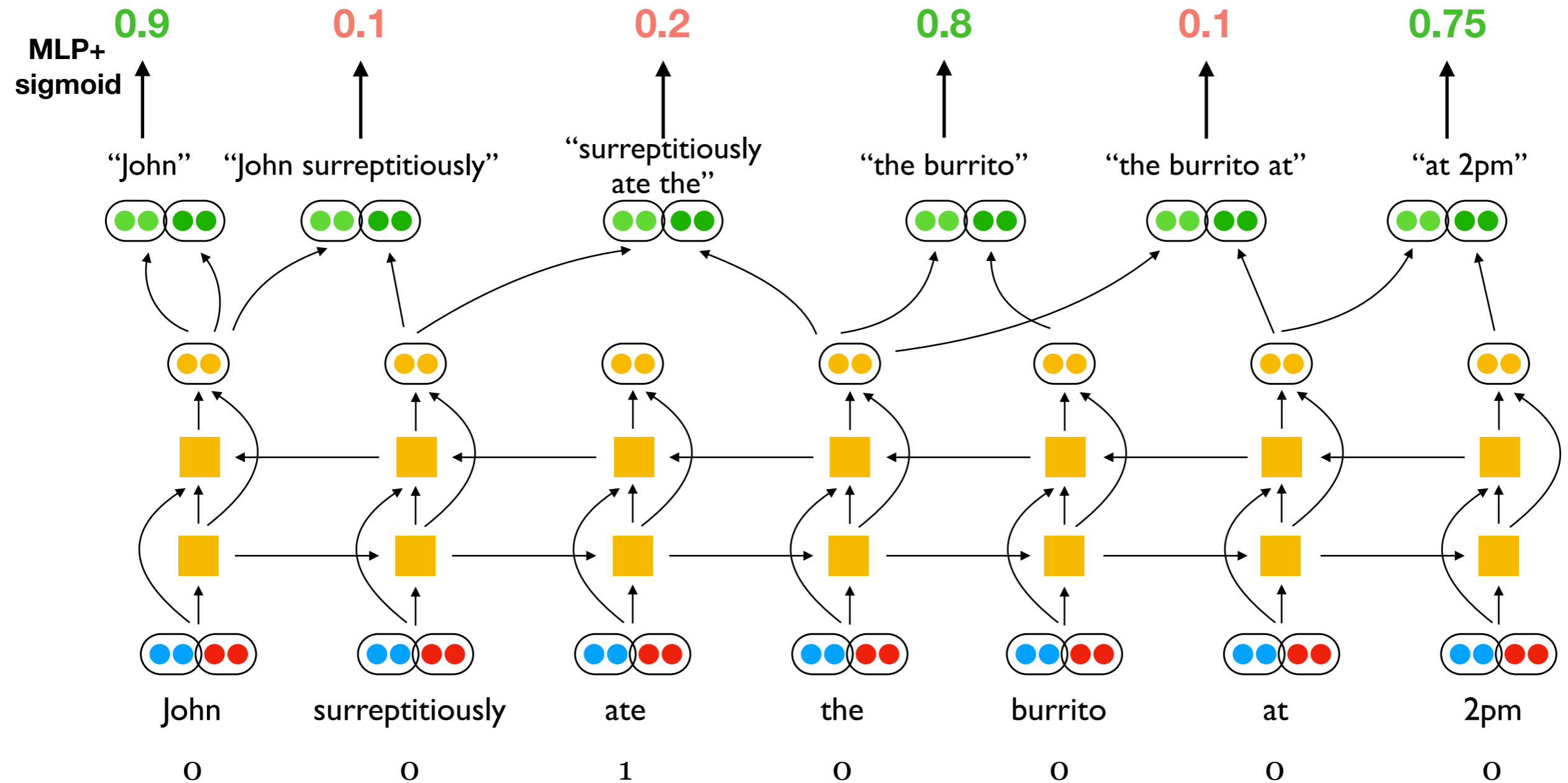

Argument Detection - Span Model

Tunable Threshold

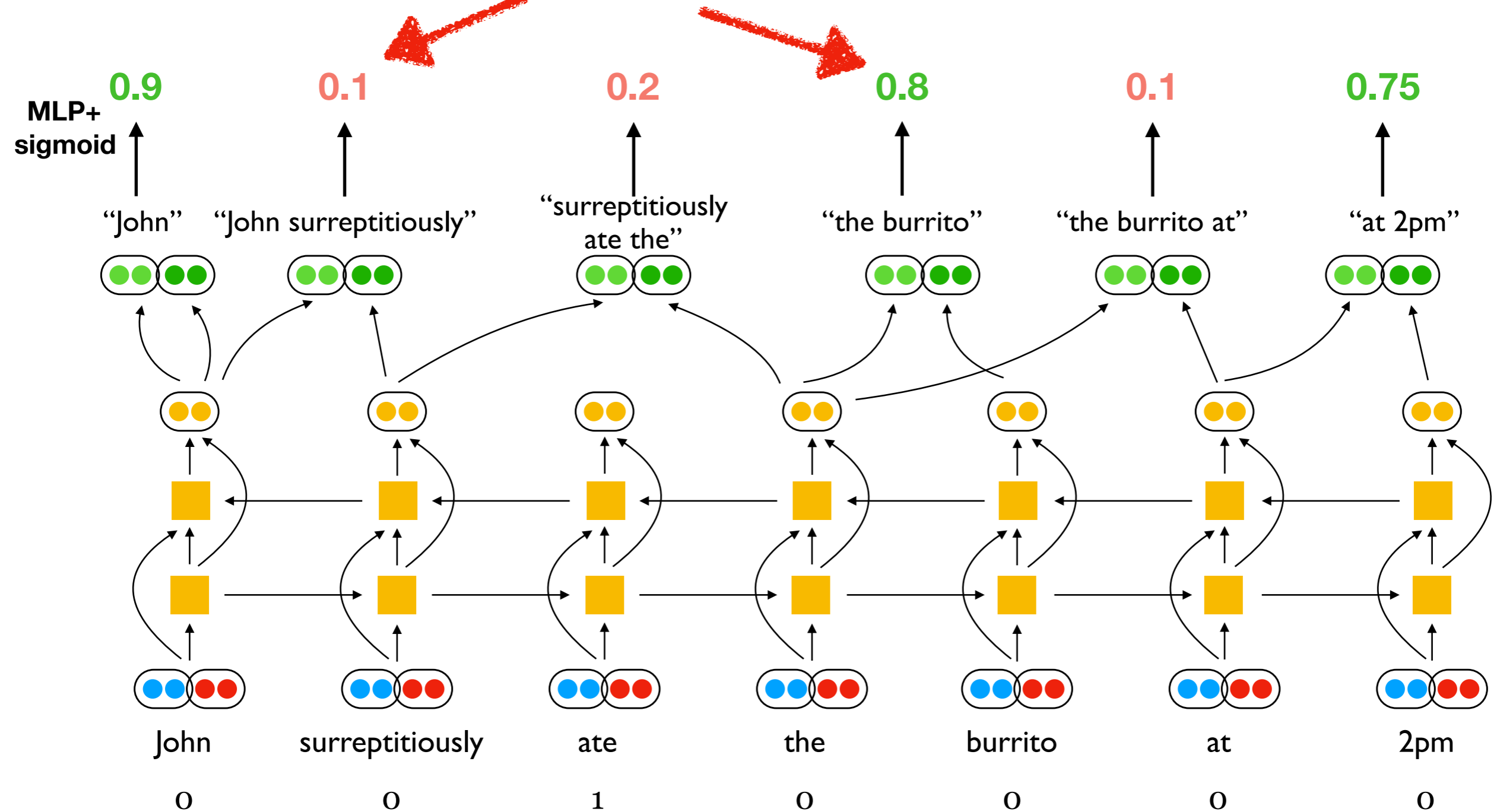

Argument Detection

- 4 layer Alternating Bi-LSTM with Highway Connections and Recurrent Dropout [He et al 2017]
- Trained to maximize log-likelihood

Argument Detection

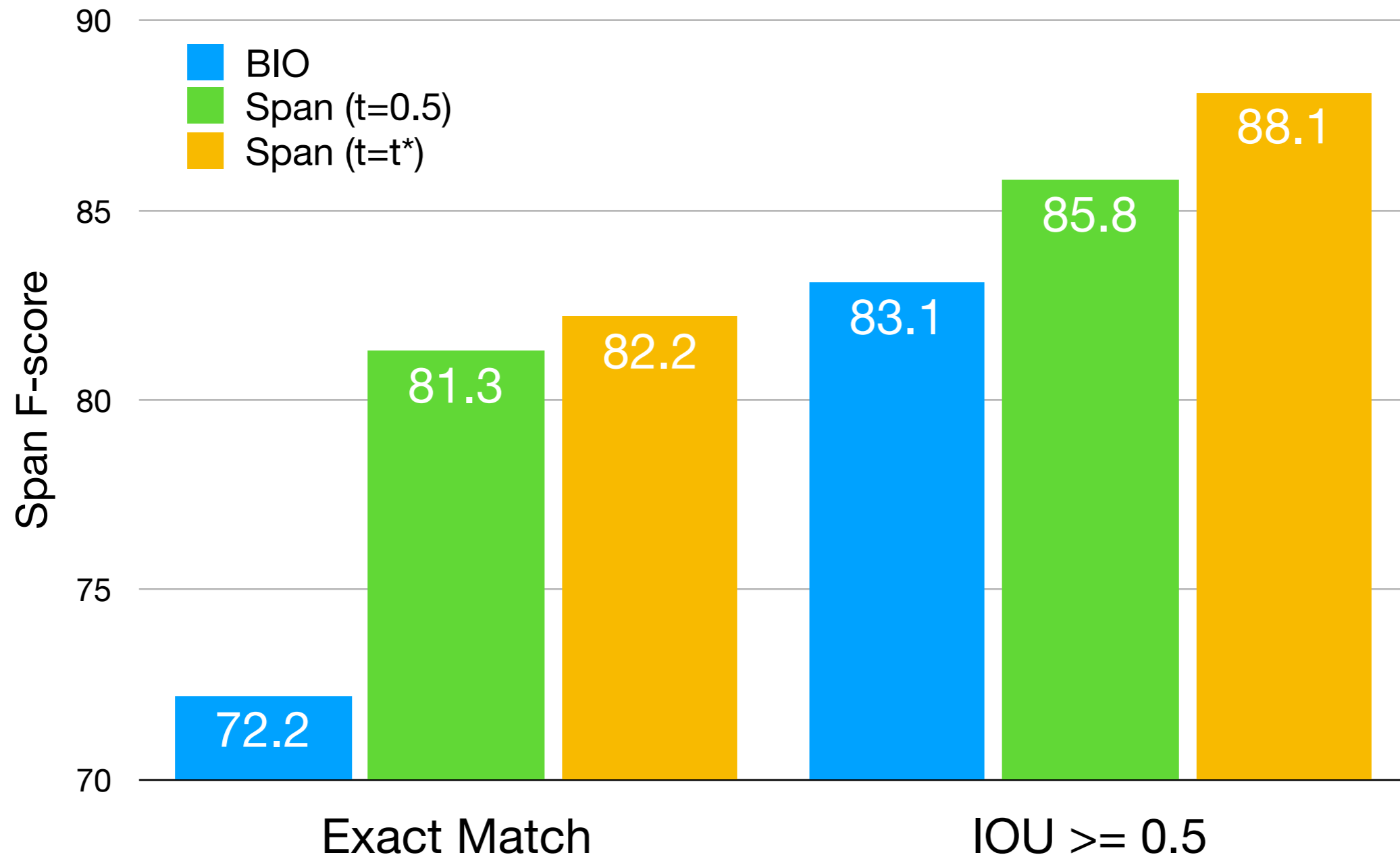

Question Generation

Wh	Aux	Subj	Verb	Obj	Prep	Obj2
Who	∅	∅	∅	∅	∅	∅
What	did	someone	stem	someone	on	someone
Where	didn't	something	past	something	to	something
When	might		past participle		by	
Why	will		present		from	
How	

Question Generation

Wh	Aux	Subj	Verb	Obj	Prep	Obj2
Who	∅	∅	∅	∅	∅	∅
What	did	someone	stem	someone	on	someone
Where	didn't	something	past	something	to	something
When	might		past participle		by	
Why	will		present		from	
How	

- Two models:
 - Local slot prediction
 - Sequential Model (LSTM)

Question Generation - Local

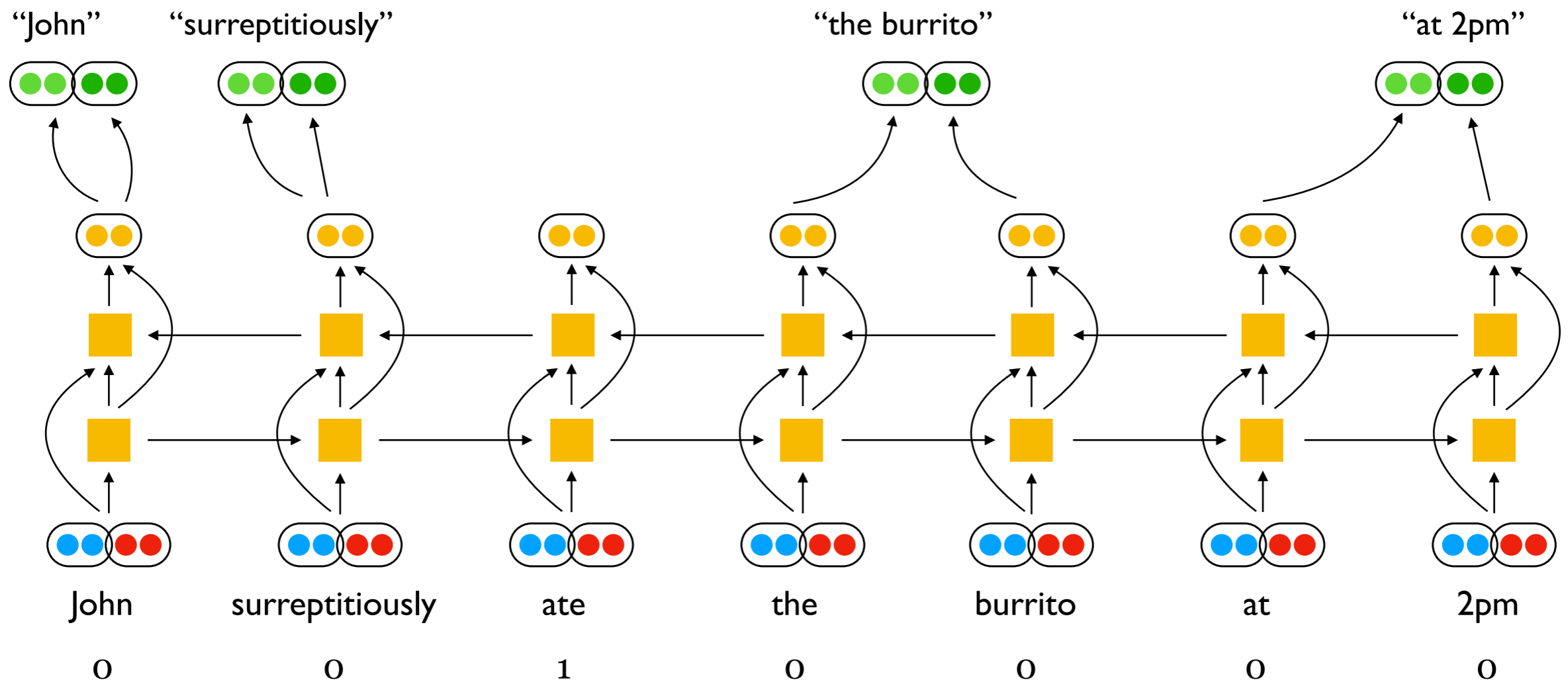

Question Generation - Local

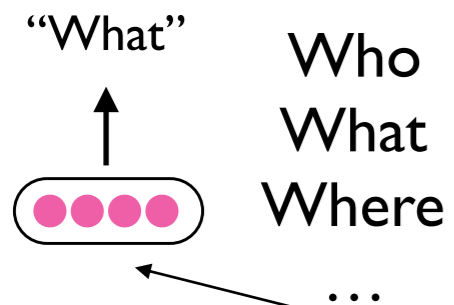
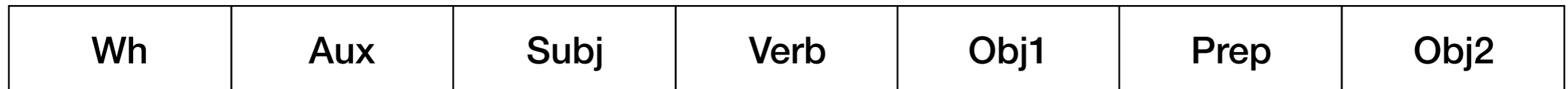

“the burrito”

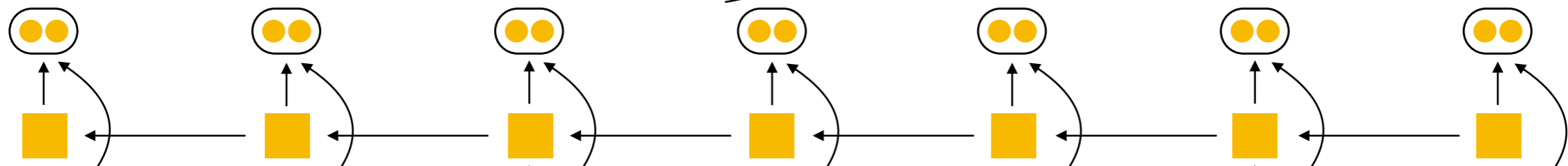

Question Generation - Local

Wh	Aux	Subj	Verb	Obj1	Prep	Obj2
----	-----	------	------	------	------	------

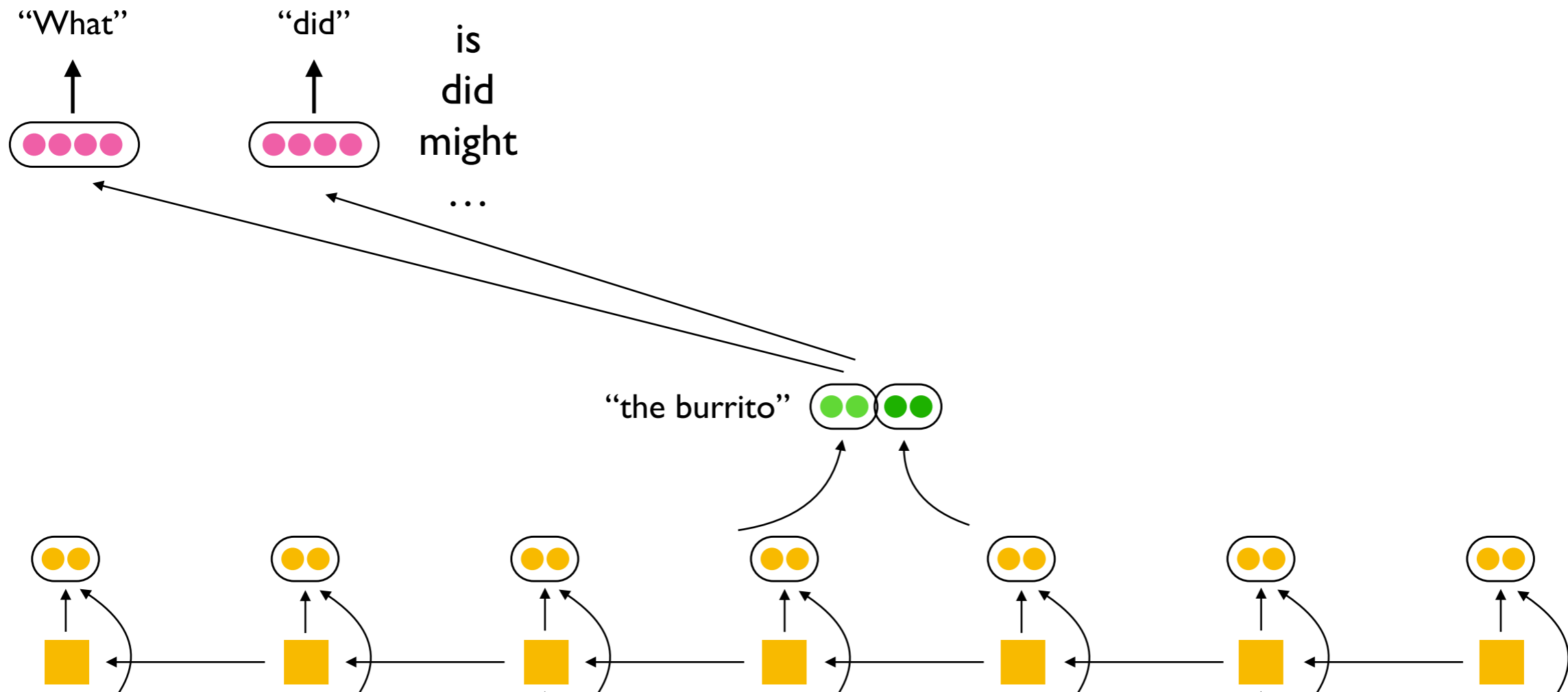

Question Generation - Local

Wh	Aux	Subj	Verb	Obj1	Prep	Obj2
----	-----	------	------	------	------	------

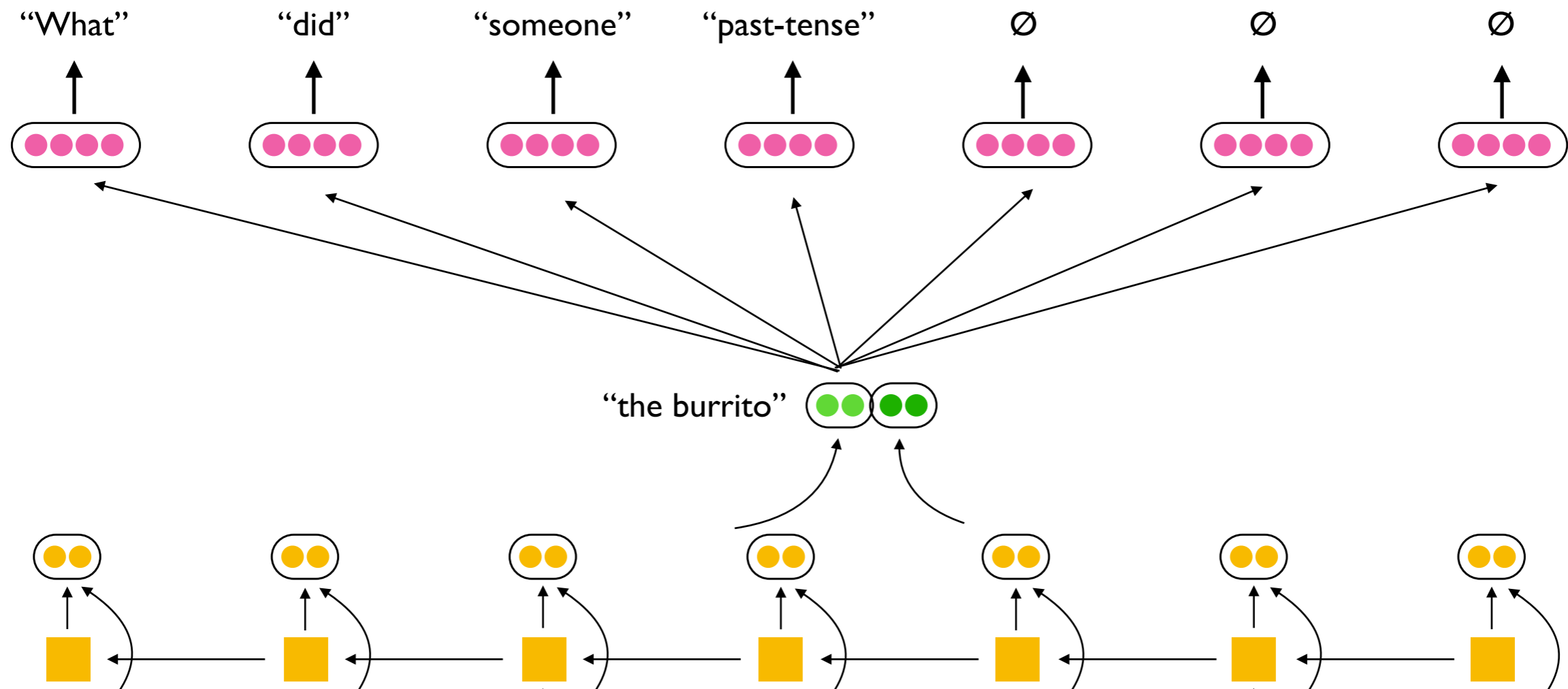

Question Generation - Sequential

Wh	Aux	Subj	Verb	Obj1	Prep	Obj2
----	-----	------	------	------	------	------

“What”

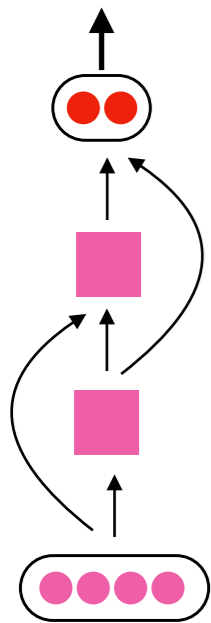

“the burrito”

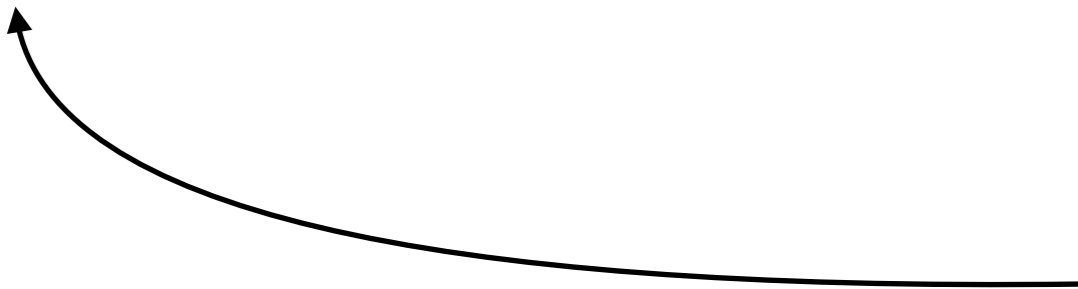

Question Generation - Sequential

Wh	Aux	Subj	Verb	Obj1	Prep	Obj2
----	-----	------	------	------	------	------

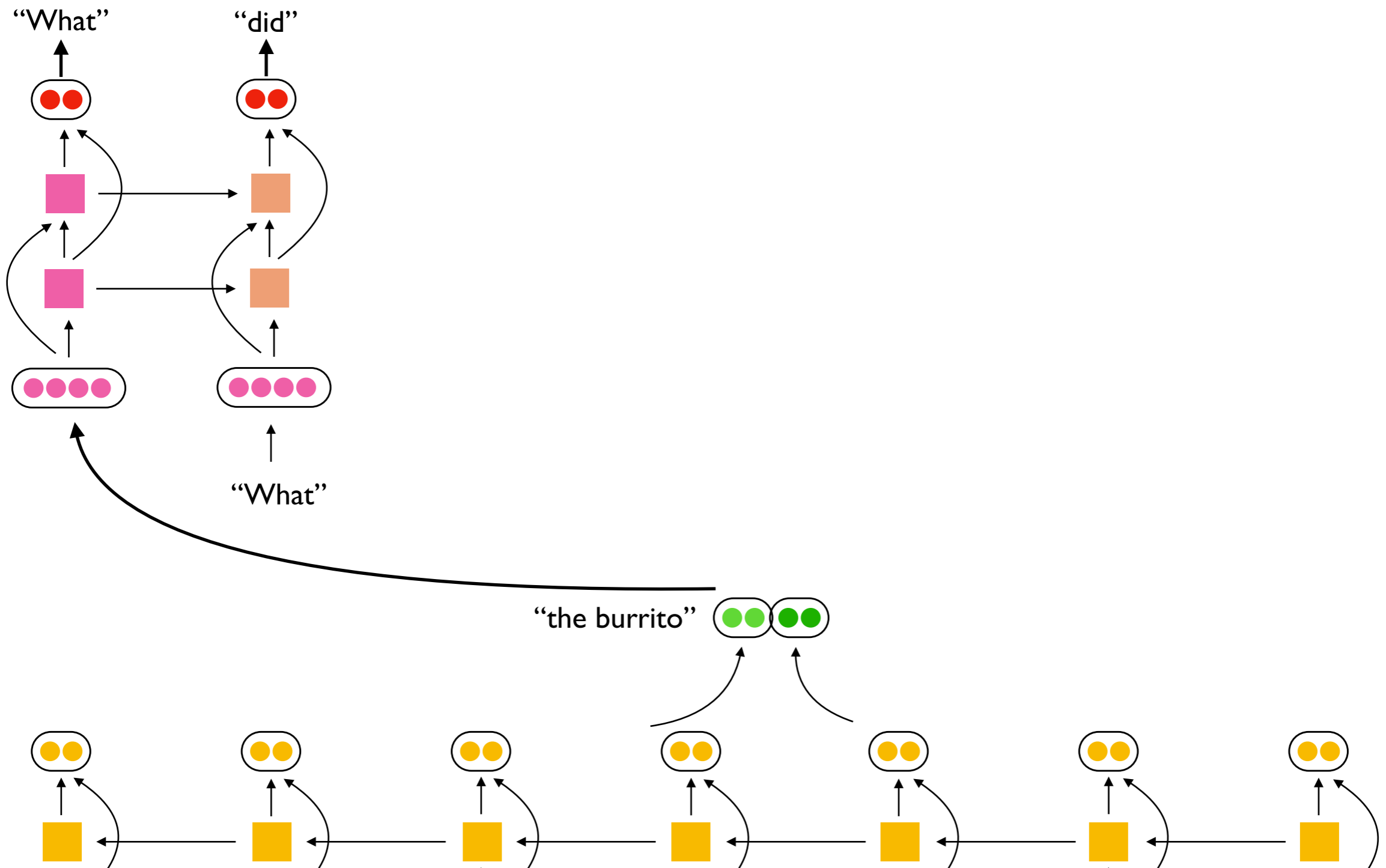

Question Generation - Sequential

Wh	Aux	Subj	Verb	Obj1	Prep	Obj2
----	-----	------	------	------	------	------

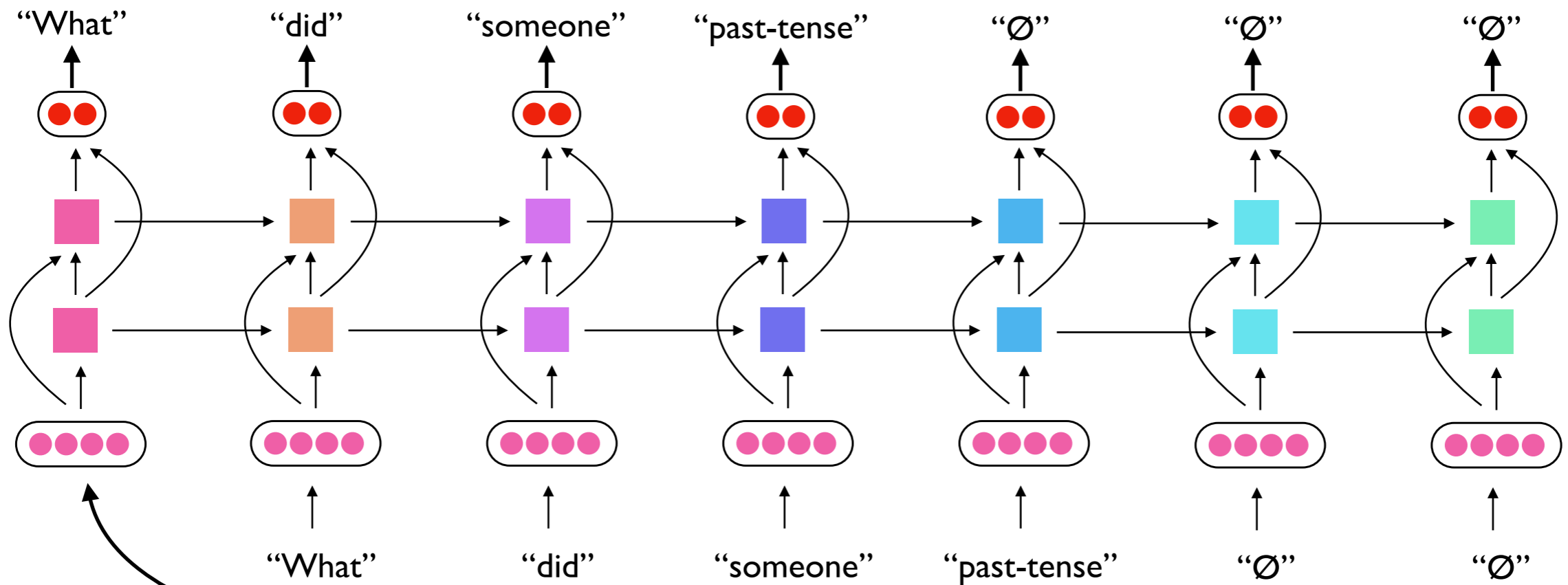

“the burrito”

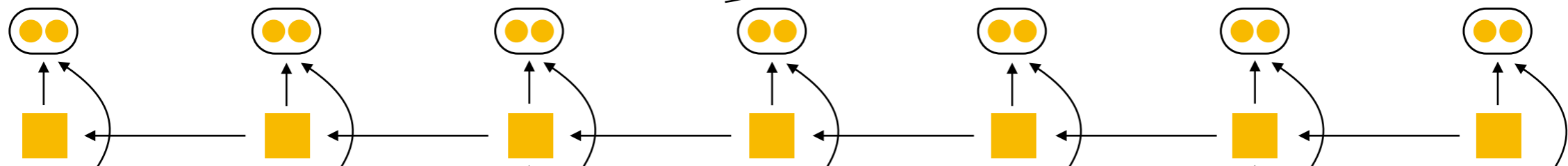

Question Generation

- 4 layer Alternating Bi-LSTM with Highway Connections and Recurrent Dropout [He et al 2017]
- Trained to maximize log-likelihood

Evaluation Questions

- Paraphrasing

“Who ate something?”

**“Who was something
eaten by?”**

Evaluation Questions

- Paraphrasing

“Who ate something?”

**“Who was something
eaten by?”**

- Given gold span:
 - Slot-level accuracy
 - Exact Match (full question)

Question Generation

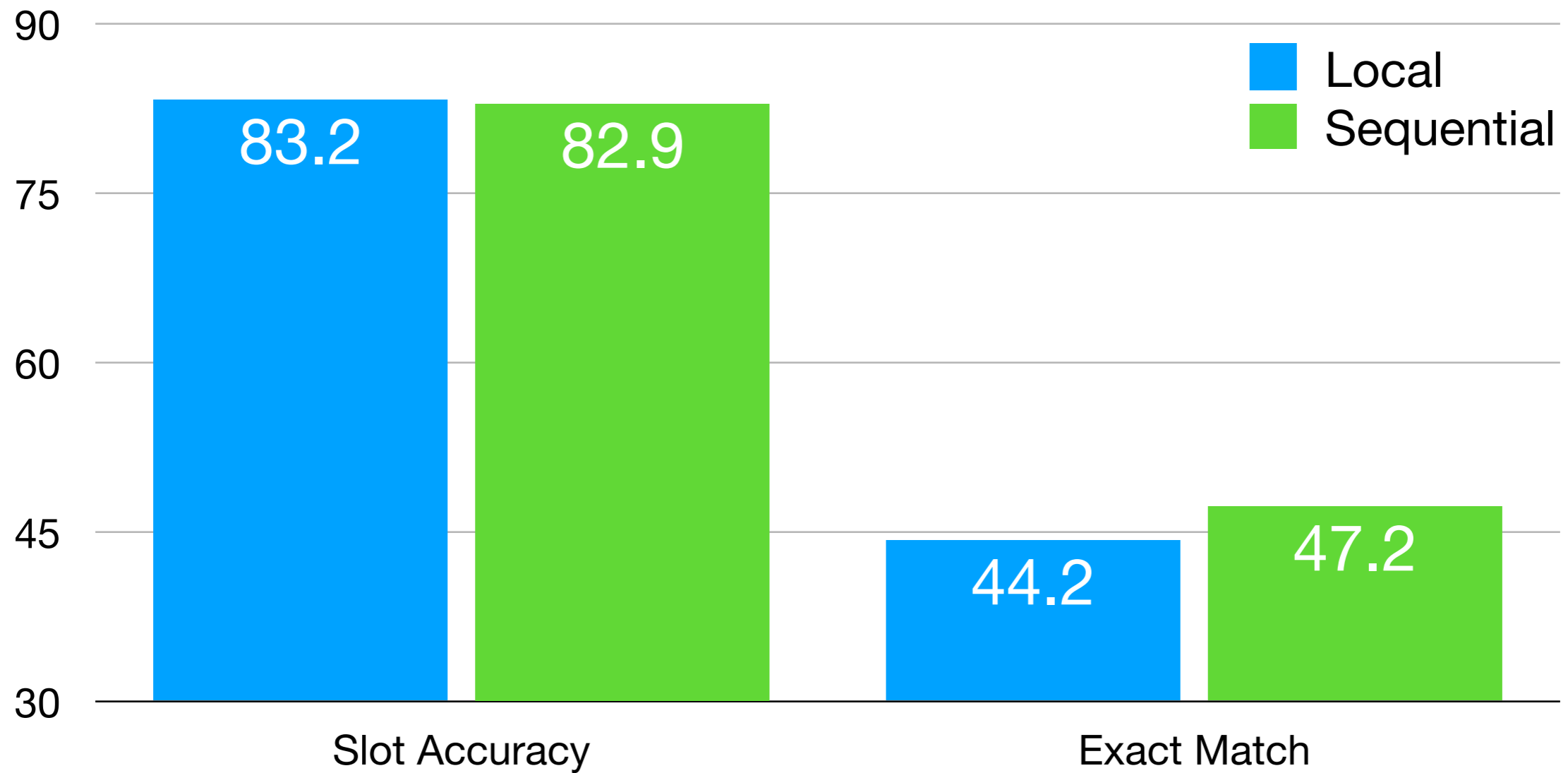

Full Parsing Accuracy

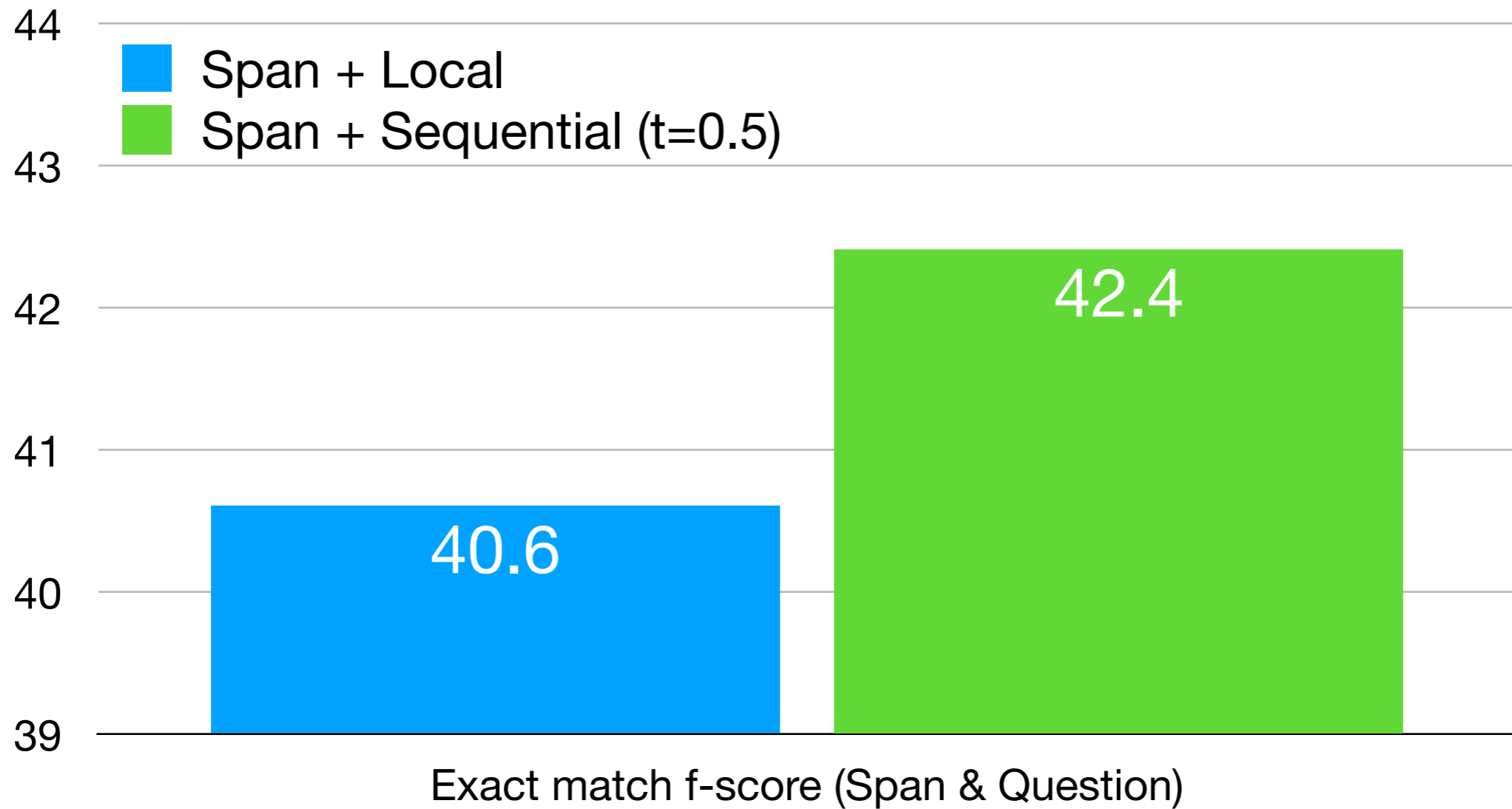

Large-scale QA-SRL Parsing

1. Scale up QA-SRL data annotation
2. Train a QA-SRL Parser
- 3. Improve Recall**

In 1950 Alan M. Turing **published** "Computing machinery and intelligence" in Mind, in which he **proposed** that machines could be **tested** for intelligence **using** questions and answers.

published	Who published something?	Alan M. Turing
	What was published?	"Computing Machinery and Intelligence"
	When was something published?	In 1950
	Where was something published?	in Mind
proposed	Who proposed something?	Alan M. Turing
	What did someone propose?	that machines could be tested for intelligent using questions and answers
	When did someone propose something?	In 1950
	What did someone propose something in?	"Computing Machinery and Intelligence"
tested	What can be tested?	machines
	What can something be tested for?	intelligence
	How can something be tested?	using questions and answers
using	What was being used?	questions and answers
	Why was something being used?	tested for intelligence

In 1950 Alan M. Turing **published** "Computing machinery and intelligence" in Mind, in which he **proposed** that machines could be **tested** for intelligence **using** questions and answers.

published	Who published something?	Alan M. Turing
	What was published?	"Computing Machinery and Intelligence"
	When was something published?	In 1950
	Where was something published?	in Mind
proposed	Who proposed something?	Alan M. Turing
	What did someone propose?	that machines could be tested for intelligent using questions and answers
	When did someone propose something?	In 1950
	What did someone propose something in?	"Computing Machinery and Intelligence"
tested	What can be tested?	machines
	What can something be tested for?	intelligence
	How can something be tested?	using questions and answers
using	What was being used?	questions and answers
	Why was something being used?	tested for intelligence

Impacts training and evaluation

In 1950 Alan M. Turing **published** "Computing machinery and intelligence" in Mind, in which he **proposed** that machines could be **tested** for intelligence **using** questions and answers.

published	Who published something?	Alan M. Turing
	What was published?	"Computing Machinery and Intelligence"
	When was something published?	In 1950
	Where was something published?	in Mind
proposed	Who proposed something?	Alan M. Turing
	What did someone propose?	that machines could be tested for intelligent using questions and answers
	When was something proposed?	In 1950
	What did someone propose something in?	"Computing Machinery and Intelligence"
tested	What can be tested?	machines
	What can something be tested for?	intelligence
	How can something be tested?	using questions and answers
using	What was being used?	questions and answers
	Why was something being used?	tested for intelligence

Fill in Gaps

Annotation Pipeline

x

John surreptitiously ate the burrito at 2pm



Identify verbs with POS + heuristics



One worker writes as many QA-SRL questions as possible,
and provides the answer



Workers are shows questions,
provide answers or mark as invalid

**Predicate
detection**

**Question
generation**

Validation

Annotation Pipeline

x

John surreptitiously ate the burrito at 2pm

**Predicate
detection**

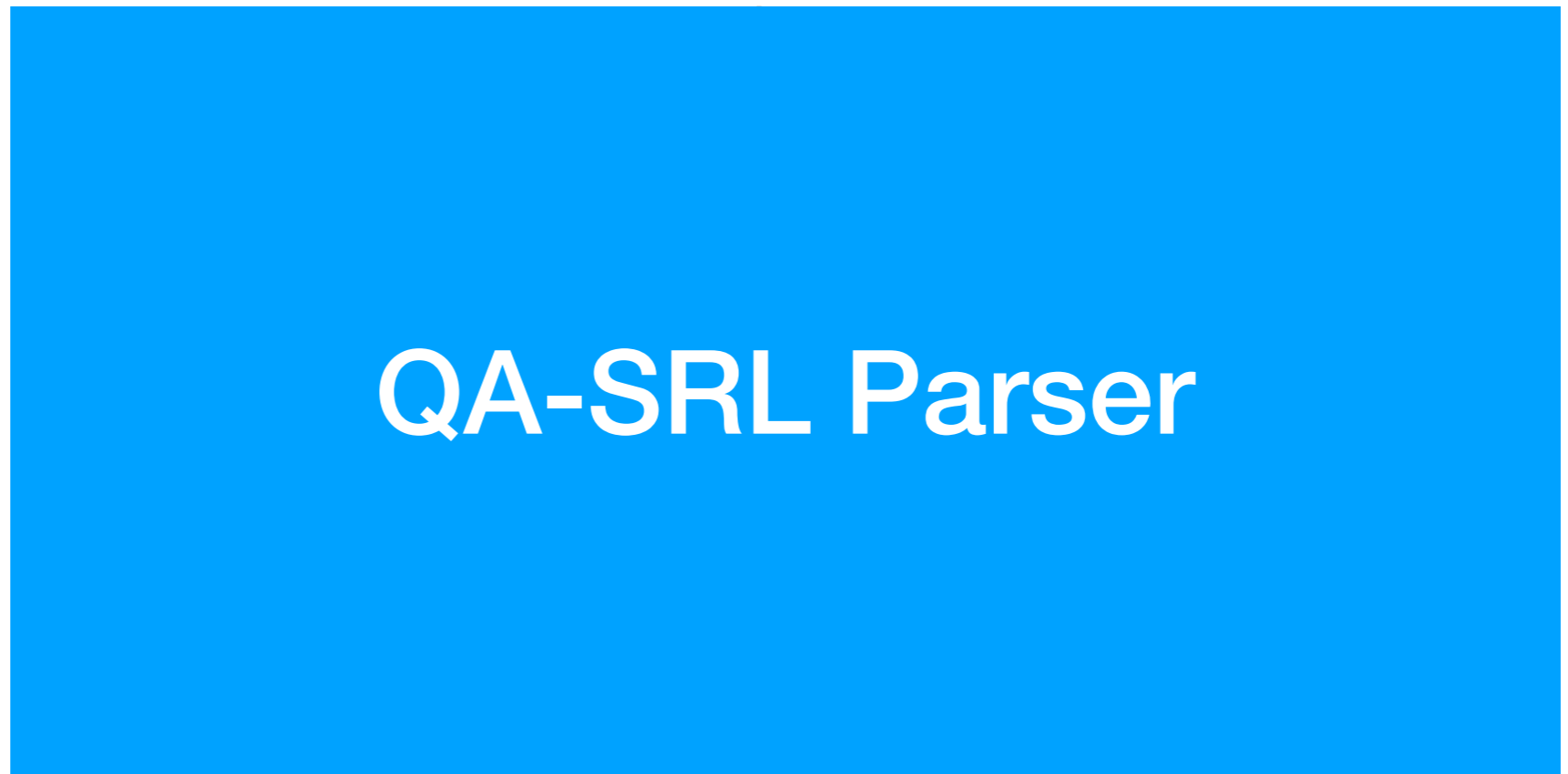

**Question
generation**



Workers are shows questions,
provide answers or mark as invalid

Validation

Data Expansion

- Overgenerate questions with low span threshold
- Validate
- +46,715 valid QA-pairs (~11% after filtering)

Data Expansion

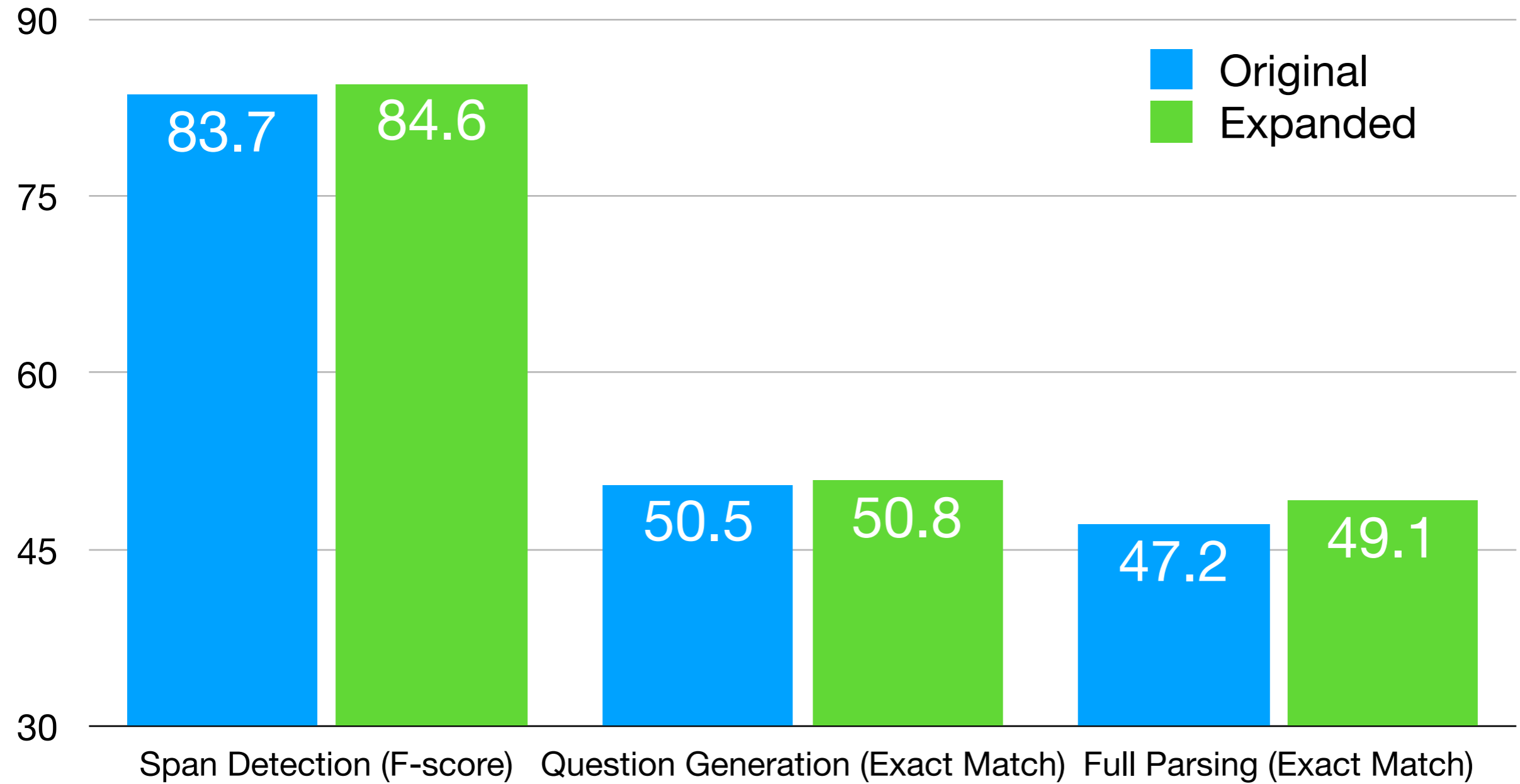

Evaluation

- Exact Match for Question Generation is overly harsh
- Paraphrasing

“Who ate something?”

**“Who was something
eaten by?”**

- Missing Questions
 - Penalizes correct predictions missing from data

Human Evaluation

- Validate model predictions with 6 annotators
- Generated Question valid if 5 out of 6 annotators provided answers
- Predicted span correct if exactly matches any annotator's answer

Human Eval - Questions

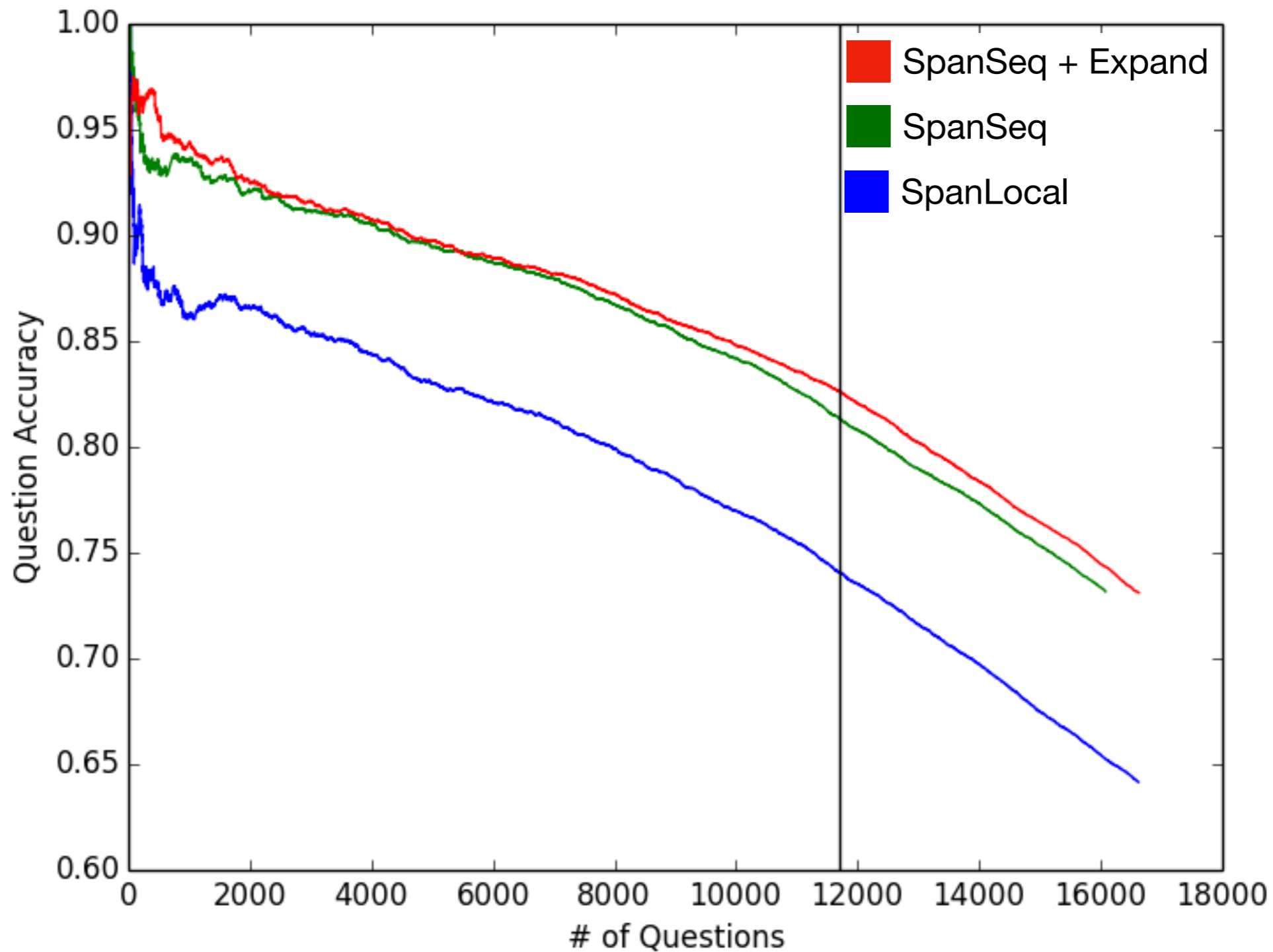

Decreasing t \longrightarrow

Human Eval - Questions

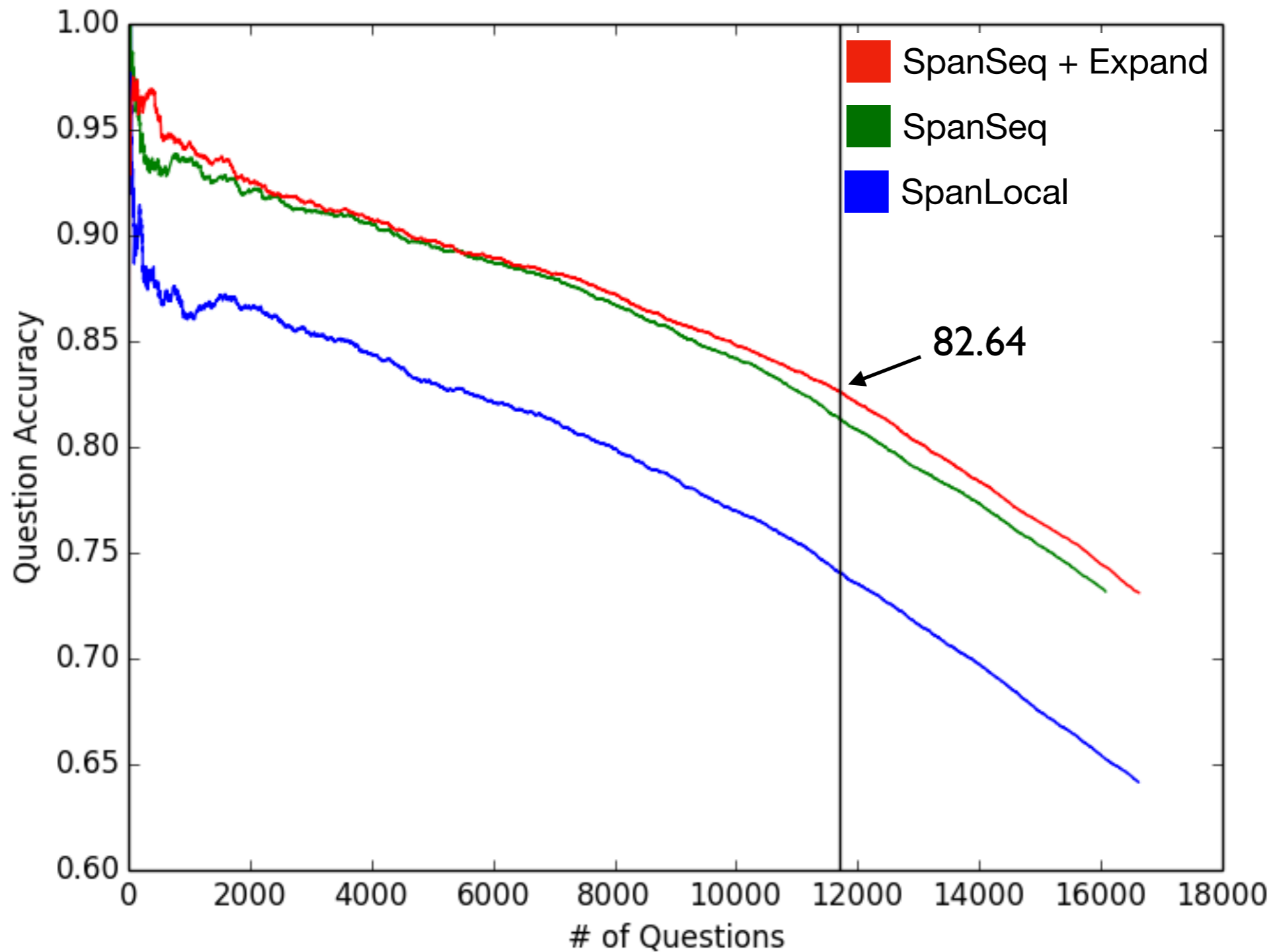

Decreasing t \longrightarrow

Human Eval - Arguments

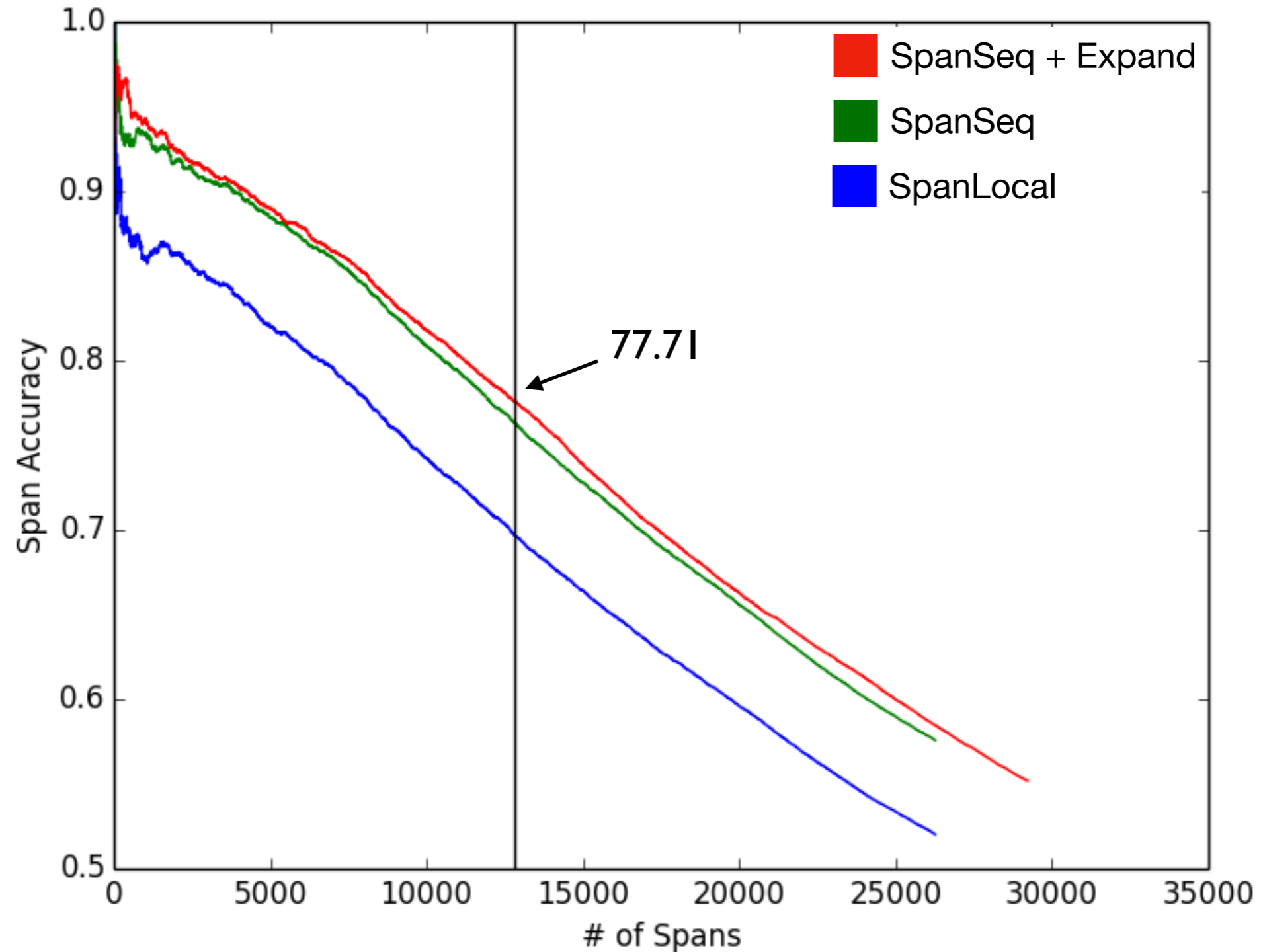

Example Output

Some of the vegetarians he **met** were members of the Theosophical Society, which had been **founded** in 1875 to further universal brotherhood, and which was **devoted** to the study of Buddhist and Hindu literature.

met	Who met someone?	Some of the vegetarians
	Who met?	he
	What did someone meet?	members of the Theosophical Society
founded	What had been founded?	members of the Theosophical Society
		the Theosophical Society
	When was something founded?	in 1875
	Why has something been founded?	to further universal brotherhood
devoted	What was devoted to something?	members of the Theosophical Society
	What was something devoted to?	the study of Buddhist and Hindu literature

Conclusion

- Large crowdsourced dataset of QA-SRL annotations
- High quality QA-SRL Parser
- Techniques for data expansion

Code and Data available at: <http://qasrl.org>

QA-SRL Bank 2.0

Train Wikipedia Original **Legend (help):** Original | Expansion | Eval
 Dev Wikinews Expansion Valid only ($\leq 4/6 \rightarrow$ invalid, $\geq 5/6 \rightarrow$ valid)
 TQA Eval Answer provided by 1/2/3/4/5/6 annotators

Search sentences

783 / 5712 documents 5 sentences Dev / TQA / T_1337 (2011 Virginia Earthquake) / paragraph 0, sentence 0

2011 Virginia Earthquake	In August 2011 the eastern seaboard of the U.S. was rocked by a magnitude 5.8 earthquake.
A Good Prediction	
Active Plate Margins	While not huge, most of the residents had never experienced a quake and many didnt know what it was.
Active Transport	
Additional Physical Properties	Some people thought the shaking might have been the result of a terrorist attack.
Advanced Topic Defining Density	
Advantage of Asexual Reproduction	But if you went back in time to the late Paleozoic, you would find the region being uplifted into the ancestral Appalachian mountains as continent-continent convergence brought Pangaea together.
Advantage of Sexual Reproduction	
After the Big Bang	

In August 2011 the eastern seaboard of the U.S. was **rocked** by a magnitude 5.8 earthquake.

rocked

What was rocked?	3/3 the eastern seaboard of the U.S.
What was something rocked by?	3/3 a magnitude 5.8 earthquake
When was something rocked by something?	3/3 In August 2011
How was something rocked?	3/3 by a magnitude 5.8 earthquake

Code and Data available at: <http://demo.qasrl.org>

QA-SRL Parser Demo

At ACL, Nicholas met other scientists and enjoyed discussing|research with them.

At ACL, Nicholas **met** other scientists and **enjoyed** **discussing** research with them.

met

Where did someone meet someone?	At ACL
Who met someone?	Nicholas
Who did someone meet?	other scientists

enjoyed

Where did someone enjoy something?	At ACL
Who enjoyed something?	Nicholas
What did someone enjoy?	discussing research with them

discussing

Where was someone discussing something?	At ACL
Who was discussing something?	Nicholas
What was someone discussing?	research
Who was someone discussing something with?	them

Thank You!

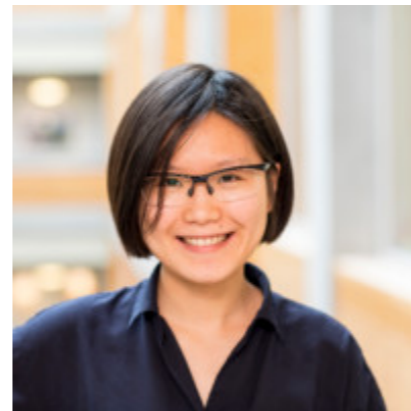

<http://qasrl.org/>

