

The Transfer Phase in an English-Japanese Translation System

Jun-ichi TSUJII

Department of Electrical Engineering
Kyoto University
Kyoto
JAPAN

1 INTRODUCTION

We will discuss in this paper several topics in a machine translation system from English to Japanese which was implemented by using ARIANE 78 at GETA (Groupe d'Etudes pour la Traduction Automatique, Grenoble, France). The system basically follows the same principles as the other GETA's systems. First of all, it uses the English analysis program in common with the other two systems, the systems from English to Bahasa, and to Chinese. This means that the same interface structure of English is used for generating three different languages. One of the research objectives is to verify the structure by applying it to Japanese. As GETA's basic ideas were explained in (1) and (2) in detail, we will concentrate here on the problems in generating Japanese, especially those in Transfer Phase.

Our generation process is, as in the other GETA's systems, divided into four independent phases, Lexical Transfer (Transfert Lexical - TL), Structural Transfer (Transfert structurale - TS), Structural Generation (Generation Structurale - GS), and Morphological Generation (Generation Morphologique - GM), which are subsequently executed in this order. The first two phases which we call "Transfer Phase" are responsible for transferring English oriented structures into Japanese oriented ones, on which necessary operations will be performed in the succeeding phases (GS and GM) to generate syntactically and morphologically correct Japanese.

Among others, the problems of transferring "Valence Structures" and "Tense and Aspect Expressions" are discussed in detail in 2 and 3, not only

because they are important problems in Transfer Phase, but also because these problems show us what kinds of "semantic" processings are necessary (or unnecessary) for transferring linguistic structures of two languages belonging to quite different language families such as Japanese and English. They also give us interesting insights into the roles of "semantics" in natural language processing in general. Some of them are summarized in 4.

2 PROCESSING OF VALENCES

2-1 BASIC SCHEME

Some syntactic forms in English (direct objects, prepositional phrases with specific prepositions, etc.) are often expressed differently in syntactic forms in Japanese. It is obvious that there are no one-to-one correspondences between syntactic functions of two languages and therefore, transforming from one language to another, based simply on syntactic functions, is not sufficient.

There are two, essentially different solutions for avoiding this difficulty. One solution is to set up intermediate "meaning" representations, through which surface forms of two languages are related. This scheme has been recurrently adopted, especially by AI-oriented researchers. The other one, which we adopted here, is the scheme called "lexical unit oriented transfer", where many idiosyncratic phenomena specific to individual lexical units are treated by referring to the descriptions in the dictionaries. In this approach, the selection of target surface forms is performed largely depending on lexical descriptions in the Bi-lingual Dictionary (BD), without referring to

universal semantic primitives or relations.

The interface structure adopted by GETA is called "multi-level analysis tree" which is a kind of annotated trees where various kinds of information of several levels such as syntactic functions (SF), logical relationships (RL), morpho-syntactic categories (K) etc. are attached to each node. Such annotation is expressed in the form of attribute-value pairs (At GETA, "attributes" such as SF, RL etc. are called "variables". We follow this convention in the following.)

Among the variables used at GETA, VL-i (i=1, 2 : Valences) and RL play important roles in every stage of translation (Analysis, Transfer and Generation). The whole process can be schematized as follows.

(Basic Scheme)

(1) The valences of each source predicate are described in analysis dictionary by using VL-i. VL-i indicates what kind of surface syntactic form is required of the element which fills the i-th argument of the predicate. Suppose that the verb "reach" has the following valences.

- (a) reach to NP (VL1:= TO)
- (b) reach NP for NP (VL1:= N, VL2:= FOR)
- (c) reach for NP (VL1:= FOR)

In the AS (Analyse Syntactique), the initial string of words is converted into an annotated tree structure by referring to these lexical description (See Fig. 1).

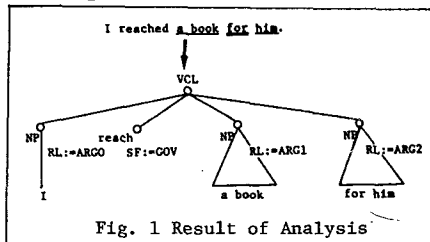

(2) The TL replaces the source lexical units in the trees with corresponding target lexical units. The target units, especially target predicates, have their own valences which show in what

surface forms the i-th arguments should be generated. Because different valence structures such as above (a), (b) and (c) often lead to different selections of target equivalents, the valence information is checked during the lexical transfer (See Fig. 2). In some cases, simple source predicates are paraphrased by composite target structures as in Fig. 3.

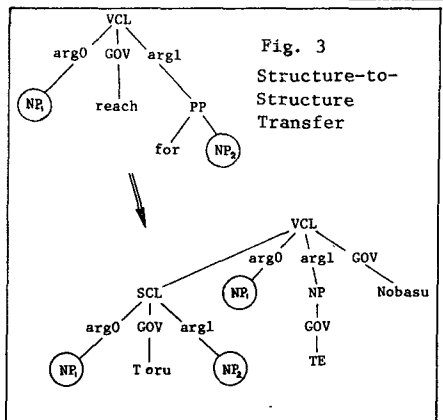
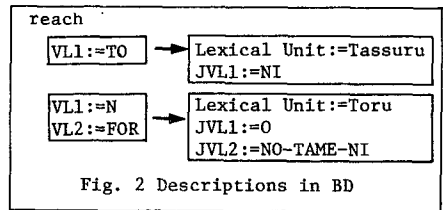

(3) The GS and GM actualize each argument in the form specified by JVL-i (See Fig. 4).

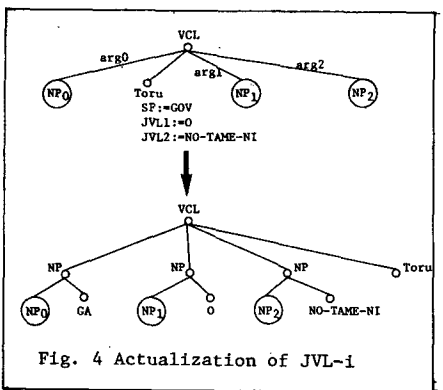

From the above scheme, though it is over-simplified in many points, we can see that the surface forms of the two languages governed by predicates are almost directly associated with each other by the descriptions in the BD.

Furthermore, one can consider that valences of a predicate describe surface usage patterns of the predicate, and that the BD associates such usage patterns of source predicates with different target expressions. Because GETA's multi-level analysis trees preserve information of various levels as much as possible, we can also use the information other than VL-1 to enrich the specifications of usage patterns. For example, the usage pattern of "take"

take the initiative in --ing,

can be specified by referring to VL-1 of "take", morpho-syntactic category of ARG2 (gerund), the specific lexical unit "initiative", etc., and this usage pattern as a whole will be associated with appropriate Japanese expressions. As such, we can transfer naturally idiomatic, semi-idiomatic, semi-semi-idiomatic --- expressions in the source into target ones. This facility is extremely important for the language pairs like English and Japanese, where we can hardly expect one-to-one correspondence between lexical units and therefore, the selection of appropriate target units is one of the most difficult problems in the whole translation process.

2-2 DISCUSSION

We adopted "lexical unit oriented transfer" or "transfer based on usage patterns" instead of using any intermediate meaning representations. It might be worthwhile mentioning our attitude toward the latter approach.

The meaning representation approach seems very attractive, but the researchers in this framework have encountered great number of difficulties in designing a complete set of semantic primitives by which subtle difference of meanings of all lexical units can be

expressed. As Boitet (2) pointed out, many systems often use source lexical units as primitives in their representation schemes, though they use certain "universal" sets of primitive relationships (Boitet (2) classified them as "hybrid" systems). However, even in such hybrid systems, to determine a universal set of primitive relationships, deep cases for example, is quite problematic. Moreover, we doubt whether such relationships are really useful for generating target sentences.

We can hardly explain without referring to the specific verbs "enter" and "go", why we say "John enters the auditorium" instead of "John enters into auditorium", while we say "John goes into the auditorium". As for deep semantic case, "the auditorium" plays the same role. The only difference is that "enter" incorporates the meaning of "into" in its meaning but "go" doesn't. Without semantic decompositions of verb's meanings, we cannot establish any rules on deep cases without referring to specific verbs, which can decide whether "into" is necessary or not. If the rules refer to specific verbs, the names of deep cases are not significant because the same deep case is differently interpreted depending on individual verbs. Why don't you use ARG1, ARG2 etc. instead of AGENT, INST etc ?

The case relationships are not so powerful in selecting translation equivalents, either. If we don't use semantic primitives only by which appropriate target equivalents can be selected, we have to refer to the surrounding contexts where the source units appear, in order to choose appropriate target equivalents. Why should we reduce the rich structures such as multi-level analysis trees into poor ones? We don't claim that semantic cases are completely useless, but only claim that a single level structure based on them is not rich enough to select appropriate target equivalents and that surface level information is also useful to specify usage patterns (or "contexts where lexical units appear").

3 PROCESSING OF TENSE AND ASPECT

3-1 BASIC SCHEME

English and Japanese have, of course, their own grammatical devices to express tense and aspect. As for aspect, for example, English has basically two surface forms, "Perfective" and "Progressive", and on the other hand, Japanese has the forms "PREDicate+AUXiliaries", where AUX is a sequence of auxiliary verbs such as "Teiru", "Tsutsuaru", "Kake+Teiru" etc. However, we should carefully distinguish between these surface forms (Grammatical Aspects) and what are really expressed by them. In the transfer phase, we should select appropriate Japanese surface forms to express what are really expressed in English. In order to do this, we set up an intermediate representation level which is deeper than surface level. The following five variables and their values are used for this purpose.

1.EASP : Lexical Aspects of English Predicates

- NCOM : Non-Completive Verbs
- NMOM: Non-Momentary Verbs
- PMOM: Momentary Verbs
- NTRAN: Non-Transitory Verbs
- PTRAN: Transitory Verbs

The above values directly correspond to the five different classes of English predicates shown in Fig. 5.

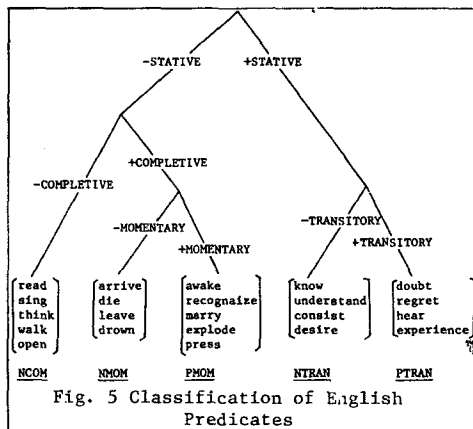

2.ESAS? : English Surface Aspectual Expressions

- PERF(Perfective Form)
- PROG(Progressive Form)

3. JASP : Lexical Aspects of Japanese Verbs

- RES: Resultative Verbs
- DUR: Durative Verbs
- INT: Instantaneous Verbs
- STATE: Stative Verbs

By combining these four values, we can discriminate the five different classes of Japanese verbs shown in Fig. 6.

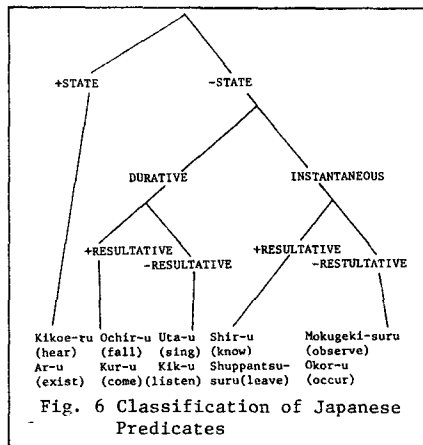

4.JSASP : Japanese Surface Aspectual Expressions

Grammatical aspects in Japanese are expressed by auxiliary verbs which follow the predicates. The values of JSASP are such auxiliaries. These values are realized as surface auxiliaries in the GS. In some cases, more than one auxiliary are needed to express the specified DASP(see below).

- TSUTSUARU, KAKARU, TESHIMAU,
- KOTOGAARU, TEIRU, TEKURU, etc.

5.DASP: Deep Aspect

- UNCOMP: Uncompletion of Action
- COMP: Completion of Action
- STATE: Absolute State
- EXP: Experience

TDUR1: Temporal Duration, including the reference time point
 TDUR2: Temporal Duration until the reference time point
 IMF: Immediate Future
 ITR: Iteration of Action
 TRANS: Transition of State
 RES: Resultant State of Action

The basic scheme for generating surface Japanese is as follows.

(Basic Scheme)

- (1) ESASP (grammatical aspect) is determined in the AS.
- (2) DASP is determined for the combination of ESASP and EASP (described in the dictionary for each English predicate - lexical aspect).
- (3) An appropriate Japanese equivalent for the English predicate is selected.
- (4) JSASP is determined based on DASP and JASP of the selected Japanese predicate.
- (5) Appropriate auxiliaries with adequate inflections are generated in the GS and GM.

The above scheme and the detailed correspondence among the values are

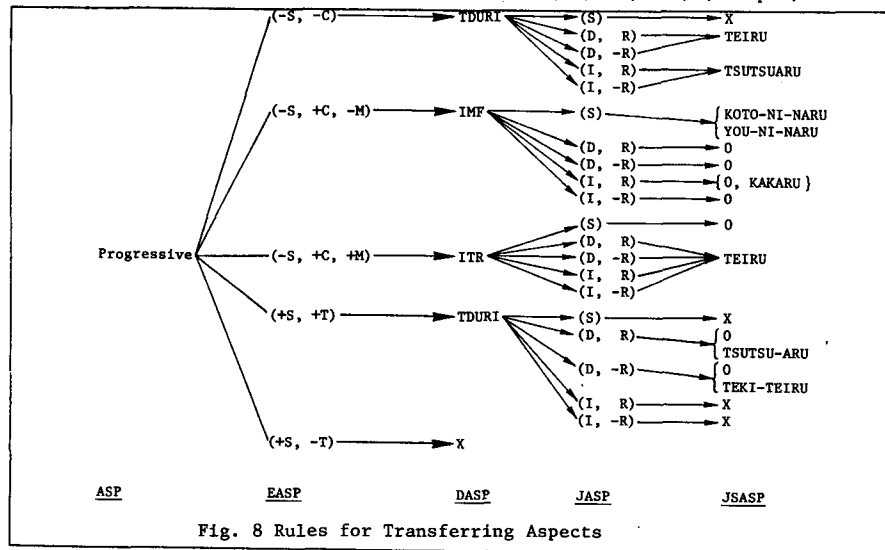

illustrated in Fig. 7, and Fig. 8, respectively. (Fig. 8 shows only the sub-portion for "progressive forms").

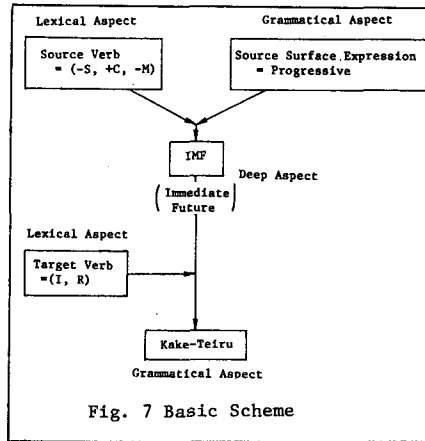

3-2 MODIFICATIONS IN THE BASIC SCHEME

The basic scheme can treat the following sentences (Here, we will see the examples of English progressive forms).

(EX 1) He is opening the door.

(EX 2) The door is opening.

Doa-GA Hiraki-TSUTSUARU.
(door) (to open)

(EX 3) He is leaving.

Kare-GA Shuppatsushi-KAKE-TEIRU.
(he) (to leave)

(EX 4) He is tapping his foot.

Kare-ga Ashibumishi-TEIRU.
(he) (to tap one's foot)

(EX 5) He is doubting his friends.

Kare-GA Tomodachi-O Utagat-TEKI-TEIRU.
(he) (friends) (to doubt)

In these examples, the same grammatical aspect in English - progressive - is realized in Japanese by using different grammatical aspects, depending on lexical aspects of both English and Japanese predicates. Note that the same DASP (TDUR1) is expressed by different auxiliaries in (EX 1) and (EX 2), because "to open" of transitive and intransitive usages correspond to the Japanese verbs "Akeru" and "Hiraku", respectively, which have different lexical aspects (Hiraku + TEIRU expresses RES, which means "the door is open").

Though it seems to work well for relatively simple sentences, the scheme has been augmented in several points, in order to treat more complicated sentences. We will give just two examples of such sophistications below.

(1) The basic scheme only gives default interpretations of DASP. That is, the interpretation given in Fig. 8 is adopted, only if there is no evidence which recommends another interpretation. Occurrences of time adverbial phrases/clauses, for example, often change the interpretation.

(EX 6) He has broken a box.
(DASP:= COMP)
He has broken boxes for two hours.
(DASP:= TDUR2)

We currently distinguish four different types of such phrases/clauses (frequentative, durative, momentary and

non-momentary), and, before the determination of DASP, a specially designed subgrammar is executed to classify the time adverbials into these types. The augmented scheme reflects the properties of such adverbials in determining DASP. Another example of evidences which shift DASP is the occurrence of special adverbs such as "ever", "yet", "already" etc.

(2) English to- and ing- clauses in predicate valences are expressed by subordinate clauses (SCL) in Japanese, and we should select appropriate surface aspectual forms for the SCL's which reflect relative time orderings among the events described by SCL's and the main clauses.

(EX 7) I saw him walking in the garden.

---- Arui-TEIRU ---- Mi-TA.
(to walk) (to see)

DASP of "he walks" is TDUR1, because the events "I see" and "he walks" occur simultaneously. TDUR1 for "Aruku(to walk)" is expressed by "TEIRU", according to the rules shown in Fig. 8.

(EX 8) I remembered walking in the garden.

---- Arui-TA --- Oboe-TEIRU.
(to walk) (to remember)

DASP of "I walk" is COMP, because it precedes in time "I remember".

(EX 9) I remember to walk in the garden.

---- Aruku-null AUX-- Oboe-TEIRU.
(to walk) (to remember)

DASP of "I walk" is UNCOMP, because it has not completed yet.

In order to treat above phenomena, valences of predicates taking to- and/or ing- clauses as arguments are augmented with the specifications of DASP of the argument clauses, and based on these specifications, the same scheme as above selects the grammatical aspects of the Japanese SCL.

We emphasize in 2 the lexical oriented nature of Transfer Phase and claimed that a universal set of case relations is not so useful as often claimed in literature. On the contrary, we set up a set of "semantic" (or deep) markers for processing aspectual expressions. Why ?

First of all, we should notice here that, although both EASP and JASP seem to describe the properties of the real world actions which are denoted by the verbs, they are just the classifications of verbs based on their linguistic behaviours in each language. When we say that the Japanese verb "shinu"(to die) belongs to the class (I, R), we don't claim that the action denoted by "shinu" is a momentary action and always happens in physically null time, but we only claim that the Japanese verb "shinu" linguistically behaves in a certain specific way. This becomes much clearer, when we consider the verb "hiraku"("to open" - intransitive use) which also belongs to (I, R). While the verb "hiraku" behaves in Japanese as an instantaneous verb, the corresponding English verb "to open" behaves as a non-momentary verb (NMOM). (Note also that, though "hiraku" is an instantaneous verb, we can express "Temporal Duration of Action" (TDUR1) by using the verb in (EX 2)). As such, the classifications given by EASP and JASP are essentially language-dependent and not universal ones.

DASP, on the other hand, is somewhat universal. Within the scheme given in 3-1, we could omit this variable by directly associating surface expressions in the BD as we did in valence transfer. That is, we could associate

```
open(transitive, ESASP:= PROG)
open(intransitive, ESASP:= PROG)
leave(ESASP:=PROG)
etc.
```

directly with

```
Akeru(JSASP:= TEIRU)
Hiraku(JSASP:= TSUTSUARU)
Shuppatusuru(JSASP:= KAKERU,TEIRU),
etc.
```

respectively. However, this direct association method cannot treat various kinds of interactions illustrated in 3-2 between DASP interpretation and the

other linguistic expressions. We need a certain level of representation through which linguistic expressions of various parts interact. Without DASP, we cannot generalize, for example, the influence of time adverbials on aspectual interpretations.

Though transferring aspectual expressions seems to be performed without referring to individual lexical units, there are several cases where we have to refer to them. This occurs when the verbs in the two languages have slightly different "meaning". The English verb "to drown" can be roughly paraphrased as "to die or kill by immersion in liquid" and, as we can see, the meaning essentially contains the concept "to die" or "to kill". "To drown" behaves linguistically in almost same manners as "to die". It belongs to the verb class NMOM (completive but non-momentary). The progressive expresses form IMF (immediate future) as shown in (EX 3). On the other hand, the Japanese translation equivalent "oboreru" denotes just the real world process of one's struggling in water not to drown, and behaves as a durative and non-resultative verb. Therefore, though the two sentences

- (a) He is drowning
- (b) Kare-GA Obore-TEIRU
- (he) (to drown)

denotes almost same situations in the real world, they describe them from different points of view, and DASP of (a) and (b) are IMF and TDUR1, respectively. The transfer process is illustrated in Fig. 9. This process re-

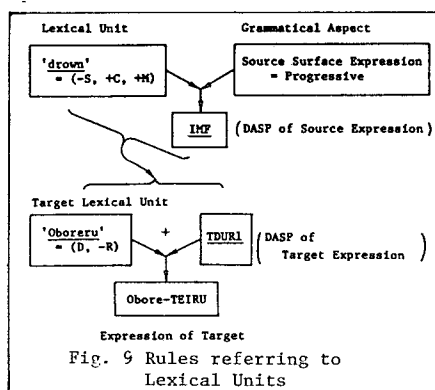

fers to the individual lexical units, "to drown" and "oboreru", and transfers "drown+IMF" into "oboreru+IDUR1" as a whole. This shows that, even in the process of aspect transfer, we need lexical-unit-oriented operations. Moreover, though we talked until now as if EASP and JASP were specified for each lexical unit, aspectual properties of predicates often change, according to their usages. Therefore, they should be specified for each usage pattern, and aspect transfer should be integrated into valence transfer in 2.

4. CONCLUSION

We discussed in this paper mainly about the role of semantics in Transfer Phase by taking examples from our English-Japanese translation system. The following points should be made clear here.

(1) We can distinguish two kinds of semantics in natural language processings, that is, "semantics as meaning representations" and "semantics as constraints (or preference)", both of which have their own analogues in linguistics, Logical Formula in MG and Selectional Restriction Rules based on semantic markers. Our contention in 2 is only that the former type of semantics is not so useful as often claimed. The latter could or should be included as descriptors in multi-level analysis trees. This is useful not only for reducing possible ambiguities in Analysis Phase but also for augmenting the descriptive power of usage patterns in Transfer Phase.

(2) We discussed about the utilization of usage patterns in Transfer Phase. However, they should be used also in Analysis Phase to reduce ambiguities. At present, only co-occurrence restrictions between predicates and specific prepositions are expressed by VL-1 and utilized in Analysis Phase, but usage patterns of predicates here are much more rich, such as co-occurrence of specific lexical units (nouns, adverbs, etc.), of phrases with specific semantic and syntactic properties etc. Because these are highly idiosyncratic and dependent on each predicate, how we can compromise these idiosyncratic matters with general rules in Analysis

Grammar remains as one of important future problems.

(3) We intentionally avoided the discussions about linguistic properties of deep cases. In fact, several grammatical rules can be founded on deep cases. By referring to deep cases, we can formulate, for example, a rule which decides whether passive construction is possible or not. Deep cases in this usage give linguistic classifications of relationships among predicates and noun phrases, but not those among events and objects in the real world. Deep cases of this type are, however, language-dependent as EASP and JASP (Rules of passivization in Japanese and English are different, for example), and therefore, we cannot use them as universal relationships in the intermediate representations. Moreover, even for linguistic deep cases, we think that it might be more practical to use the other kind of markers such as markers directly showing the possibility of passivization etc.

(4) Though DASP is claimed to be universal, this claim should be verified in future by applying it to other language pairs. In fact, the values of DASP reflect many properties specific to English and Japanese. That is, we set up the values of DASP only to distinguish the aspectual features (of real world events) which lead to different surface aspectual forms of English or Japanese. These should be distinguished in order to transfer aspectual expressions appropriately. Other languages might express explicitly in surface forms different aspectual features of events from different points of view. Because of this language-dependent property of DASP, we perform both the interpretation of ESASP and the determination of JSASP in Transfer Phase.

REFERENCES

- (1) B.Vauquois(1976):Proc. of COLING 76, 127-135
- (2) C.Boitet(1980):Proc. of COLING 80, 430-436