

A Frame-Based Semantics of Locative Alternation in LTAG

Yulia Zinova

Heinrich Heine University Düsseldorf
Germany

zinova@phil.uni-duesseldorf.de

Laura Kallmeyer

Heinrich Heine University Düsseldorf
Germany

kallmeyer@phil.uni-duesseldorf.de

Abstract

In this paper we present an analysis of locative alternation phenomena in Russian and English within a frame-based LTAG syntax-semantics interface. The combination of a syntactic theory with an extended domain of locality and frames provides a powerful mechanism for argument linking. Furthermore, the concept of tree families and unanchored trees in LTAG allows for a decomposition of meaning into lexical and constructional components.

1 Introduction

There is a number of formalisms that capture the idea that the meaning of a verb-based construction depends both on the lexical meaning of the verb and on the construction in which the verb is used (Goldberg, 1995; Van Valin and LaPolla, 1997). The question is how exactly the meaning components are distributed and how they combine.

In (Kallmeyer and Osswald, 2012a) a combination of Lexicalized Tree Adjoining Grammars (Joshi and Schabes, 1997) and Frame Semantics is introduced. Since LTAG displays an extended domain of locality and, related to this, elementary trees contain slots for all arguments of their lexical anchor, LTAG is particularly well-suited for combining it with a frame-based compositional semantics. When coupling an elementary tree with a semantic frame, as proposed in (Kallmeyer and Osswald, 2012a), syntactic arguments can be directly linked to their counterpart in the semantics. Semantic composition is then modeled by unification which is a result of performing adjunctions and substitutions. Figure 1 provides a simple illustration of syntactic and semantic composition.

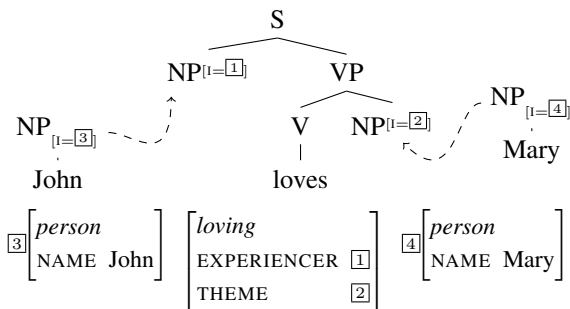

Figure 1: Derivation for *John loves Mary*

Linguistic generalizations in LTAG are captured a) by the distinction between lexical anchor and unanchored elementary tree, b) by the concept of tree families (representing subcategorization frames) and c) by the factorization in the metagrammar. Parallel to this syntactic factorization, a factorization of meaning is possible as well. The resulting framework is very flexible with respect to the decomposition and composition of lexical and constructional units on the syntax and semantics level.

In the following, we present an analysis of locative alternation that benefits from the flexibility of this framework. The structure of the paper is as follows. The next section presents the English and Russian data we are dealing with in this paper. Then, in section 3, we briefly introduce the framework of frame semantics in LTAG that we are using. Section 4 proposes an analysis of the locative alternation in English and Russian within this framework. In section 5, we further decompose the meaning of some Russian verbs, analyzing the semantics of certain prefixes that change the verb meaning such that a locative alternation becomes possible. Finally, section 6 concludes.

2 The Data

(1) - (4) show basic examples of locative alternation in English and Russian. As there is no standard name for these constructions in the literature, let us call the first variant ((1), (3)) *prepositional phrase construction*, or *PPC*, and the second variant ((2), (4)) - *instrumental case construction*, or *ICC*, for convenience of referring to them.

- (1) John₁ loaded the hay₂ into the wagon₃.
 (2) John₁ loaded the wagon₃ with hay₂.
 (3) Ivan₁ zagruzil seno₂ v vagon₃.
 Ivan loaded_{perf} hay_{acc} in wagon_{gen}.
 Ivan loaded the hay into a/the wagon.
 (4) Ivan₁ zagruzil vagon₃ senom₂.
 Ivan loaded_{perf} wagon_{acc} hay_{instr}.
 Ivan loaded the wagon with hay.

PPCs are traditionally analyzed as having a change of location meaning and ICCs as having a change of state meaning (Kageyama, 1997; Levin and Rappaport Hovav, 1998; Goldberg, 1995). An analysis for (1) and (2) following (Kageyama, 1997) is provided in (5). It demonstrates that there is a difference between the two constructions, but only the difference in the perspective is shown.

- (5) a. X CAUSE [BECOME [hay BE ON truck]]
 b. X CAUSE [BECOME [truck_z BE [WITH [hay BE ON z]]]]
 (6) a. [[x ACT] CAUSE [y BECOME P_{loc} z] [LOAD]_{MANNER}]
 b. [[x ACT] CAUSE [z BECOME [STATE WITH-RESPECT-TO y] [LOAD]_{MANNER}]

The analysis proposed in (Levin and Rappaport Hovav, 1998), which can be found under (6), provides more detailed information about the difference between PPCs and ICCs. (6-a) tells us that the hay changes its location as a result of the loading event, while (6-b) describes that the result is a change in the state of the wagon. One can notice that in (5) there is no explicit reference to the verb itself and the only component that is taken from the verb meaning is that the result of the loading is that the THEME is on the LOCATION in the end.

The question that arises if one looks carefully at what the sentences in (1) - (4) mean is whether

it is really the case that there is no change of state in PPC examples? In fact, any loading activity leads to both a change of location of the content and some change of state of the container (if it is specified), just different components of the effect become more salient. As there is actually only one action, we propose the following formalization: the verb describes a change of location and the result state depends on the end amount of PATIENT at the GOAL. If this amount is equal to the capacity of the container, we get the change of state effect. If it is equal to the total amount of content, we have a holistic change of location effect.

Although at first Russian examples look similar to the English ones, there are a number of differences. While (4) has the same meaning as (2), (3) means that all the hay was loaded. On the other hand, if we consider imperfective examples (7) and (8), we find no holistic effect in either ICC and PPC case. Verbs *gruzit* 'to load' and *mazat* 'to spread', 'to cover' (examples (9) and (10)) are the only non-prefixed verbs that allow locative alternation in written language¹. Other verbs allow only one construction in their non-prefixed variant (see (11) and (12)) and both constructions, when a prefix *za-* is added (see (13) and (14)). A prefix *na-* makes the verb perfective but does not change the set of constructions it can participate in, like in (15) and (16).

- (7) Ivan₁ gruzil seno₂ v vagon₃.
 Ivan loaded_{imp} hay_{acc} in wagon_{gen}.
 Ivan was loading the hay into a/the wagon.
 (8) Ivan₁ gruzil vagon₃ senom₂.
 Ivan loaded_{imp} wagon_{acc} hay_{instr}.
 Ivan was loading the wagon with hay.
 (9) On namazal maslo na hleb.
 He distributed_{perf} butter_{acc} on bread_{acc}.
 He distributed butter over a piece of bread.
 (10) On namazal hleb maslom.
 He covered_{perf} bread_{acc} butter_{instr}.
 He covered a piece of bread with butter.
 (11) On sypal sahar v banku.
 He put_{imp} sugar_{acc} in can_{acc}.
 He was putting sugar in a/the tin.
 (12) *On sypal banku saharom.
 He covered/filled_{imp} tin_{acc} sugar_{instr}

¹A couple more can be found in spoken language, for example *stelit* 'to cover'

- He covered/filled the tin with sugar.
- (13) On zasypal sahar v banku.
He put_{perf} sugar_{acc} in can_{acc}
He put sugar in a/the tin.
- (14) On zasypal banku saharom.
He covered/filled_{perf} tin_{acc} sugar_{instr}
He covered/filled the tin with sugar.
- (15) On nasypal sahar v banku.
He put_{perf} sugar_{acc} in can_{acc}
He put sugar in a/the tin.
- (16) *On nasypal banku saharom.
He covered/filled_{perf} tin_{acc} sugar_{instr}
He covered/filled the tin with sugar.

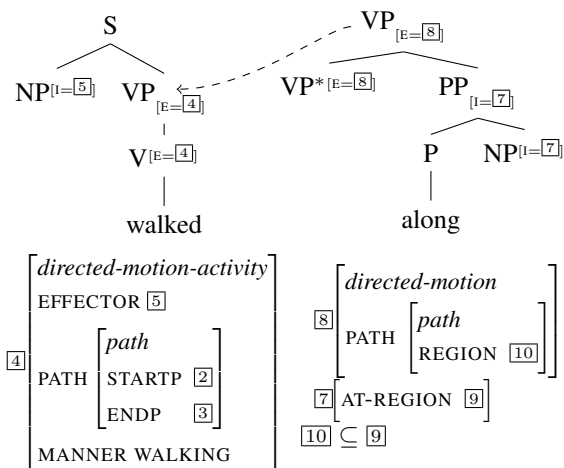

Figure 2: Path modification

The aim of this work is to provide an analysis that correctly models the following: a) holistic effects for English ICC constructions, b) holistic effects for Russian PPC and ICC constructions with perfective verb, and c) no holistic effect in other cases. We also aim at providing an explanation of why some verbs allow locative alternation and some do not and how the addition of a prefix to a Russian verb changes the set of constructions it can participate in.

3 LTAG and Frame Semantics

Following (Kallmeyer and Osswald, 2012a), we adopt a syntax-semantics interface that links a single semantic representation (in our case, a semantic frame) to an entire elementary tree and that models semantic composition by unifications triggered by substitution and adjunction. In this we partly follow (Gardent and Kallmeyer, 2003; Kallmeyer and Romero, 2008), except that our focus is on event semantics and the decomposition of lexical meaning and we therefore use frames.

Formally, frames are taken to be typed feature structures. Each elementary tree is linked to a feature structure and unification is triggered via the feature unifications in the syntax. For this purpose, some of the nodes in the elementary trees have semantic features such as I (for individual) and E (for event). Their unifications cause equations between metavariables. As a result, the corresponding semantic feature structures are unified as well. A simplified example was given in Fig. 1 where the substitutions trigger unifications between 1 and 3 and between 2 and 4, which leads to an insertion of the corresponding argument frames into the frame of *loves*.

An example taken from (Kallmeyer and Osswald, 2012a) involving an adjunction is given in Fig. 2 where the path of a walking activity is further restricted by an *along ...* PP modifier. The frames express that the AT-REGION of the NP embedded under the PP (for instance *the brook* in *John walked along the brook*) contains the REGION of the path. This containment is expressed as an additional relation between feature values.

Note that the feature structures used for semantics are more complex than the syntactic feature structures used in LTAG. However, this complexity is limited to the semantic part, the complexity of syntactic parsing remains unchanged.

As detailed in (Kallmeyer and Osswald, 2012a), LTAG's decomposition of elementary trees into a) unanchored trees and lexical anchor and b) tree fragments of unanchored trees in the metagrammar can be paired with a corresponding decomposition of meaning, in particular into contributions of constructions and of lexical elements. In this paper, we will exploit this for a distinction of the meaning contributions of ICC and PPC constructions and of their lexical anchors.

4 Locative Alternation: The Analysis

In this section, we will examine the possible unanchored trees involved in our examples of locative alternations, relating the elementary tree templates to the semantics of the construction. Furthermore, we will detail the semantics contributed by lexical anchors and we will show how syntactic composition triggers semantic frame unification.

In the case of the PPC in English, the semantics of the whole phrase can be compositionally

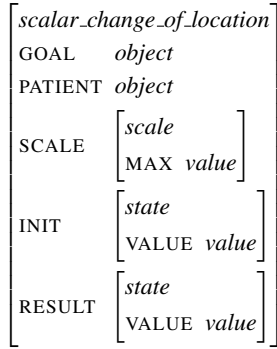

Figure 3: Signature for *scalar change of location*

derived from the semantics of the verb and its arguments, while in the case of the ICC there is a part of the meaning, that comes from the construction itself. The goal now is to provide the meaning of the ICC and of the verbs allowing locative alternation such that in combination they form the desired frame representation of the semantics of a sentence.

4.1 Feature Geometry

Following ideas in (Osswald and Van Valin, Jr., 2012) where one can find a discussion of the representation of events and results using Fillmore's Frame Semantics (Fillmore, 1982) we introduce attributes of initial and result states and a scale which is determined by its type, maximum and minimum value. The change of state is either a decrease or an increase of a value on an ordered scale (a discussion of an analysis of scalar change can be found in (Kennedy and Levin, 2008)). The type of change of state determines the way the change happens. For example, change of location requires a patient and a goal and the patient is then moved to the goal according to the scale (for example, covered area or amount). Inside the scale attribute the maximum value (feature MAX) is specified, the minimum value is assumed to be 0. Some of the verbs specify a concrete initial or result state (INIT and RESULT respectively), but *load* does not have any initial or result state specified within its semantics, so it just determines the scale with its maximum. Summarizing the ideas, one obtains the following for our analysis of locative alternation:

- change of location and change of state are just different interpretations of the result state of the scalar change of location;
- a scalar change of location is described by

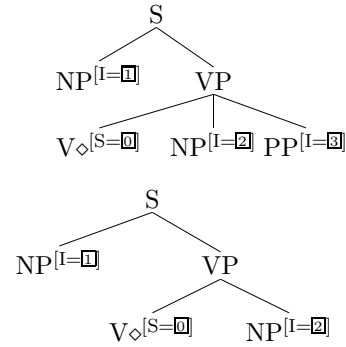

Figure 4: Unanchored trees for the PPC

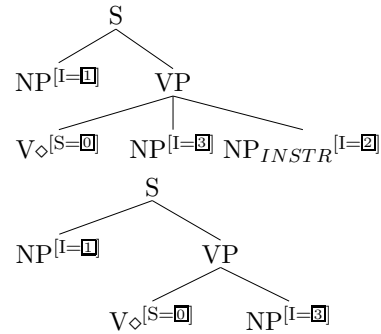

Figure 5: Unanchored trees for the ICC

PATIENT, GOAL, SCALE and initial and result values on it, which means that there is a change of location of PATIENT to GOAL, such that the amount of PATIENT at the GOAL changes from the initial to the end value (cf. Fig. 3);

- the value of SCALE is of type *scale* with possible subtypes such as *volume*, or *area*, which can also have subtypes such as *capacity* and *amount* for *volume* or *coverage* for *area*.

4.2 The Construction

So far, we were looking only at examples where both container and content are realized. However, the constructions that are being discussed can also be used when only the direct object of the verb is present; in this case, they will have the same difference in semantics. Therefore, for the PPC and ICC construction, we obtain the unanchored elementary trees shown in Fig. 4 and Fig. 5.² In the ICC trees, the second NP_{INSTR} stands for both NP in instrumental case in Russian and PP with

²For this paper, we restrict ourselves to the base trees; other trees (for extraction and passivization, for instance) are of course in the tree family as well.

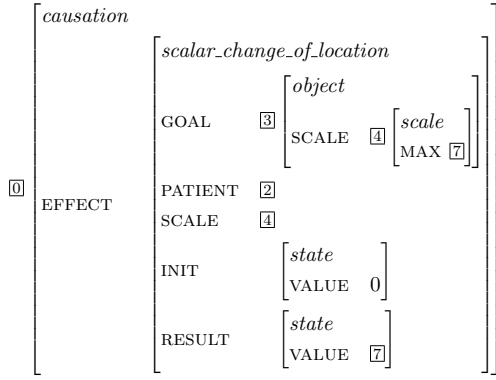

Figure 6: Frame for the ICC (English)

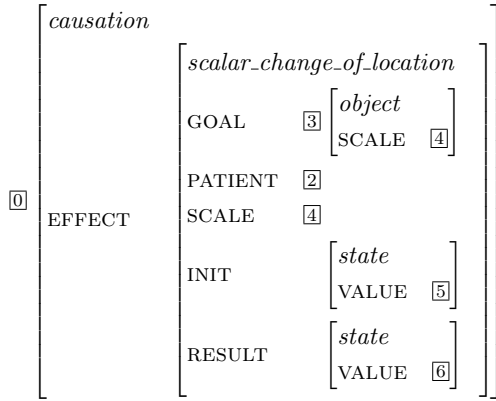

Figure 7: Frame for the ICC (Russian)

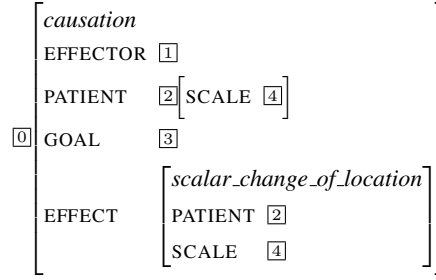

Figure 8: PPC frame (English, Russian)

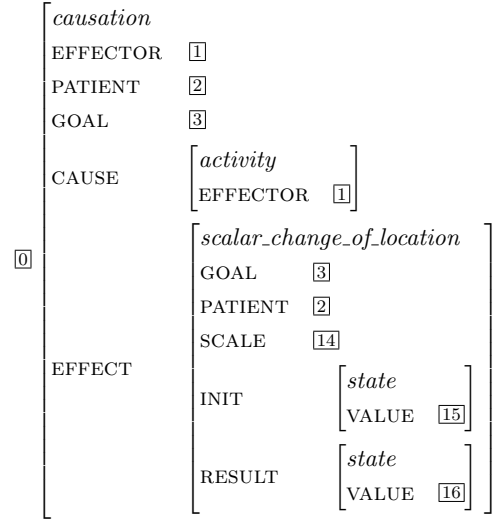

Figure 9: Frame for *load* (English, imperfective in Russian)

preposition *with* in English.³

Let us present our analysis by going through the decomposition of the verbal trees for (1) - (4).

Figures 6 and 7 show the frames for the unanchored trees for the ICC in English and Russian respectively. The frame for the PPC is common for both languages and represented in Fig. 8. In all three frames, the scalar change of location is embedded under the EFFECT attribute of the *causation* event that describes the meaning of the verbal construction. The ICC frame in Fig. 6 expresses that in the initial state there is nothing at the GOAL and in the result state the amount of PATIENT at the GOAL is equal to the maximum value specified in the SCALE inside the GOAL. This gives us the meaning that if the GOAL is a container and thus has a *capacity* scale, it's result state will be *full*. As already mentioned, in Russian this is not necessarily so. Therefore, in Fig. 7, the effect of the causation is less specified. The part which is

more specified in the English ICC construction, compared to the Russian one, comes with the perfectivizing prefixes, like *na-* and *za-*. The PPC frame (Fig. 8) expresses that the relevant scale for the change of location is provided by the patient.

4.3 Semantic Frame Composition

Let us first go through the full composition of (2). Fig. 9 gives the lexical semantics of *load*. When anchoring the ICC construction with *load*, yielding the tree in Fig. 10, the frames from Fig. 6 and Fig. 9 unify. The result is given in Fig. 11.

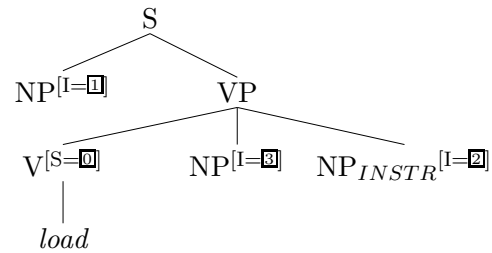

Figure 10: Elementary tree for *load*, ICC construction

³Note that, in order to adjoin VP modifiers, a more binary structure is actually needed. In this respect, our trees are slightly simplified for the sake of this paper.

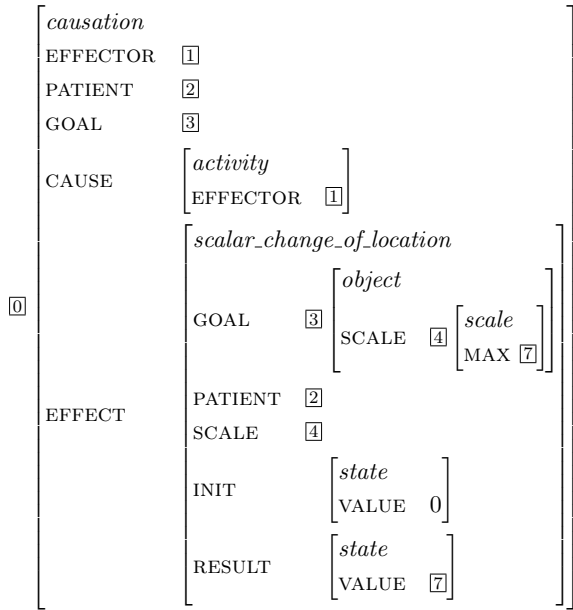

Figure 11: Frame for the *load* ICC tree (English)

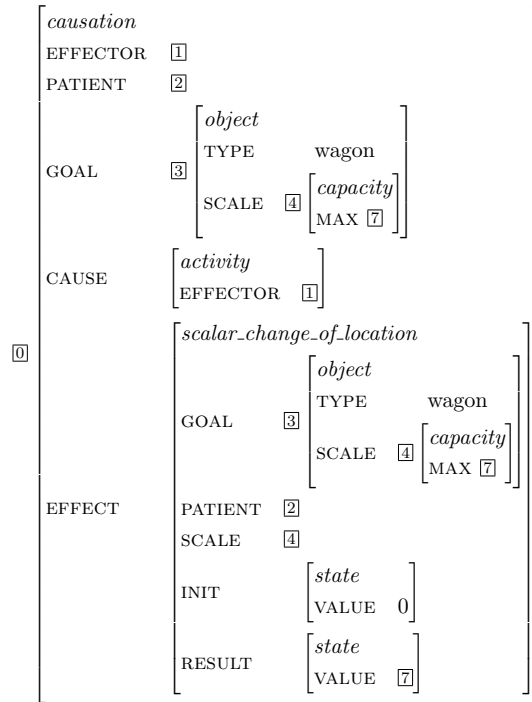

Figure 13: Frame for *load wagon* (ICC)

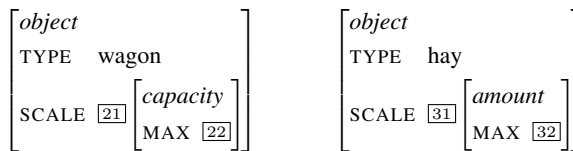

Figure 12: Frames for *wagon* and *hay*

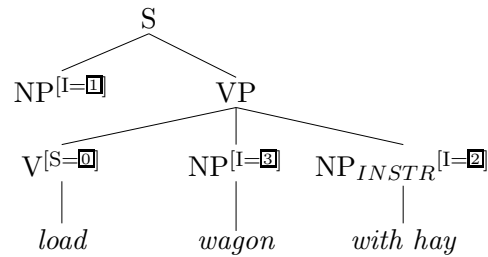

Figure 14: Tree for *load wagon with hay*

We assume that frames for nouns such as *wagon* or *hay* come with a SCALE attribute that can be for instance of type *capacity* as for *wagon* or *amount* as in the case of *hay*, see Fig. 12. When substituting the *wagon* into the direct object position, because of the linking I features, the value [3] of the GOAL feature in the frame in Fig. 11 is unified with the *wagon* frame. As a result, the maximal value on the *capacity* scale of the *wagon* provides the value of the result state, yielding the frame in 13. At the next step, *hay* is substituted into the instrumental object slot in the tree (see Fig. 14), causing a unification of its frame with the value [2] of PATIENT. The resulting frame (Fig. 15) represents that in the result state the amount of hay in the wagon is equal to the maximal capacity of the wagon, in other words the wagon is full. As we have seen, the construction determines which scale is relevant for the result state; in an ICC construction it is the scale of the goal, i.e., the capacity of the wagon.

In contrast to this, in the PPC construction, the scale of the PATIENT is the relevant scale for the scalar change of location. In the case of *hay*, the

change can be up to the total amount of hay. However, as expressed in the PPC frame, the RESULT value is not necessarily equal to the MAX value of the relevant scale. Consequently, no holistic effect arises in this case.

5 Morphological Decomposition

Let us now turn to the Russian examples (11) - (16). There are two questions we aim to answer:

- How does holistic meaning arise?
- Why does adding the prefix *za-* make some verbs eligible for both ICC and PPC?

The idea is that most verbs, for example *sypat'* 'to pour, but for non-liquids', have a restriction on the type of their relevant scale (see frame in Fig. 16), which does not allow them to combine with nouns that do not have an appropriate scale type, like *banka* 'can' whose frame is

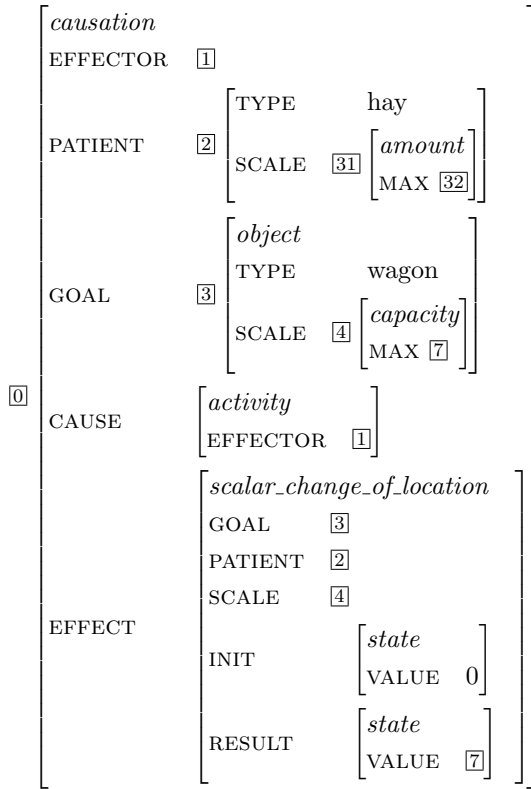

Figure 15: Resulting frame for the ICC and *load wagon with hay*

shown in Fig. 17. Note that, in contrast to the previous section, we now allow multivalued (i.e., set-valued) scale values for cases where several scales are possible. *Can* for instance has both a surface (*area*) that can be covered and a volume (*capacity*) that can be filled. When unifying with such a multivalued attribute, unification with one of the values must be successful. When adding the noun in direct object position, the SCALE inside the *change_of_location* must unify with the SCALE of the noun. In the case of *sypat'* the unification fails since the type *amount* cannot unify with any of the two scale types of *can*.

What happens when a prefix is added? First, the perfective meaning is added (the part of the meaning that comes together with the ICC in English), see frames for both *na-* (Fig. 19) and *za-* (Fig. 18). Second, if the prefix *za-* is added, the scale restriction is removed (20). If the prefix *na-* is added, the restriction remains. As a preliminary analysis of this, let us introduce attributes that can overwrite something instead of unifying with it. This operation is allowed only on the morphological level and thus does not affect the compositionality of semantic derivation. The under-

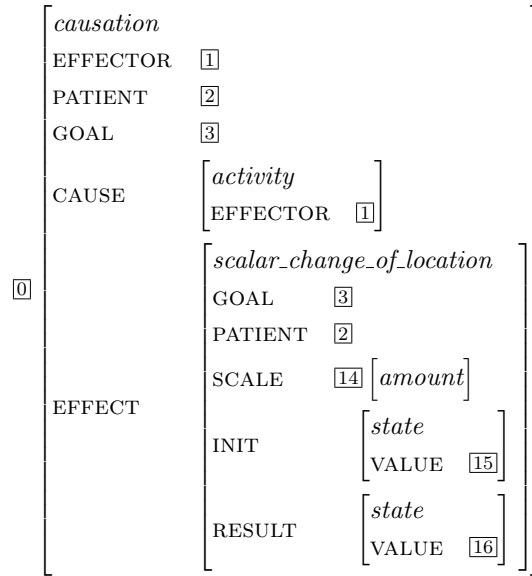

Figure 16: Frame for Russian verb *sypat'*

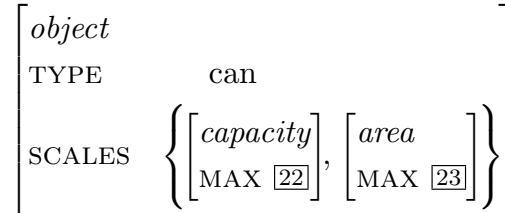

Figure 17: Frame for *banka* (can)

lined SCALE attribute in the frame for *za-* prefix (Fig. 18) replaces the SCALE attribute in the verb frame and we obtain the resulting frame in 20 for the verb *zasypat'* 'to cover', 'to fill'.⁴

This analysis is in line with ideas from (Filip, 2000; Filip, 2003), where the meaning of Slavic prefixes is discussed. Both prefixes presented here derive a perfective verb from an imperfective one, but with different meanings: while *zasypat'* is a quantized verb, *nasypat'* (as well as *sypat'*) is a cumulative one and this leads to the restrictions on the direct object type (which is here expressed via the type of scales).

After the morphological step is computed, only standard unification is used. However, now the verb can participate in both the PPC and ICC constructions because it is now unifiable (after combination with the construction frames) with objects of container type (like *can*), as well as with objects of a content type (like *hay* or *sugar*).

⁴A more detailed investigation of the morphology-semantics interface is planned for future research.

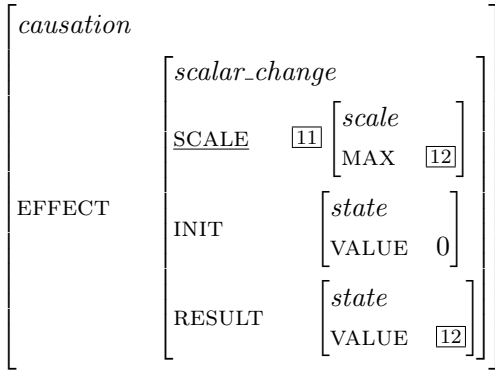

Figure 18: Frame for the prefix *za*

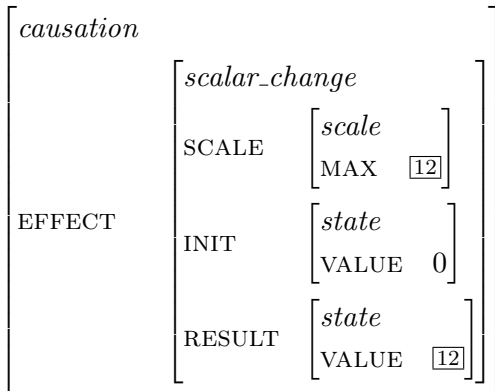

Figure 19: Frame for the prefix *na*

As mentioned above, at the moment we assume multiple values for the SCALE attribute of objects like *banka* 'can'. An alternative solution might be to store the object frame in the lexicon with characteristic attributes of this object, such as a CAPACITY attribute with a value of maximum capacity of the object, and then allow for such attributes to be transformed in the SCALE attribute. We leave this issue for future research.

Let us illustrate the multivalued approach that we currently assume by performing the substitution of the noun *banka* 'can', Fig. 17 into the tree for the verb *gruzit'* 'to load' in the ICC. There are two different scale types inside the object of *can* available for the unification while substituting *can* in a direct object position in the ICC, *capacity* and *area*. As there is no restriction on the type of the scale inside the verb, both unifications are possible and lead to different interpretations of example (14): in case the capacity scale is selected, the result state of the can is *full* (Fig. 21) and in case the area scale is selected, the can is *covered* (Fig. 22).

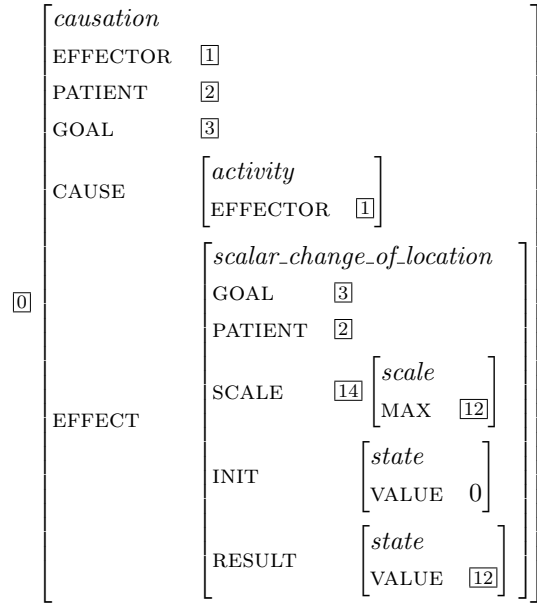

Figure 20: Frame for Russian verb *zasypat'*

6 Conclusion

In this paper we present an analysis of locative alternation phenomena in Russian and English using the combination of an LTAG and Frame Semantics. This analysis uses LTAG's mechanism of separation between unanchored elementary trees and lexical anchors to separate the contribution of the lexical meaning from the contribution of construction and follows the ideas expressed in (Kallmeyer and Osswald, 2012b). An advantage of combining LTAG with Frame Semantics is that LTAG's extended domain of locality allows direct linking of thematic roles of the arguments with corresponding syntactic slots. From the other side, Frame Semantics allows a reach meaning factorization, as is illustrated in the provided analysis of locative alternation.

Additionally, some ideas for morphological decomposition are presented, which is especially useful for languages with a rich morphology, such as Russian.

Acknowledgments

The work presented in this paper was financed by the Deutsche Forschungsgemeinschaft (DFG) within the CRC 991. For inspiring discussions and many useful comments we would like to thank Hana Filip, Timm Lichte and Rainer Osswald. Furthermore, we are grateful for the comments provided by three anonymous reviewers.

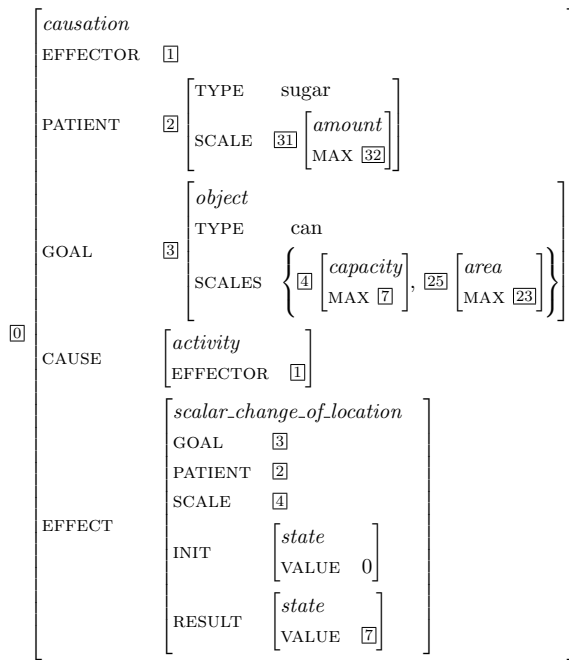

Figure 21: Frame for (14), 'fill' variant

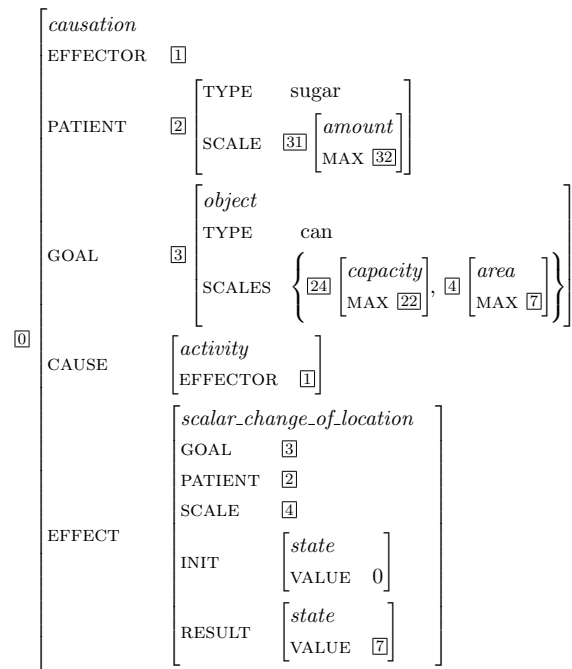

Figure 22: Frame for (14), 'cover' variant

References

- Hana Filip. 2000. The quantization puzzle. In *Events as Grammatical Objects*, pages 3–60. CSLI Press, Stanford.
- Hana Filip. 2003. Prefixes and the delimitation of events. *Journal of Slavic Linguistics*, 1(11):55–101.
- Charles J. Fillmore. 1982. Frame semantics. In The Linguistic Society of Korea, editor, *Linguistics in the Morning Calm*, pages 111–137. Hanshin Publishing Co., Seoul.
- Claire Gardent and Laura Kallmeyer. 2003. Semantic Construction in FTAG. In *Proceedings of EACL 2003*, pages 123–130, Budapest.
- Adele E. Goldberg. 1995. *Constructions. A Construction Grammar Approach to Argument Structure*. Cognitive Theory of Language and Culture. The University of Chicago Press, Chicago and London.
- Aravind K. Joshi and Yves Schabes. 1997. Tree-Adjoining Grammars. In G. Rozenberg and A. Salomaa, editors, *Handbook of Formal Languages*, pages 69–123. Springer, Berlin.
- Taro Kageyama. 1997. Denominal verbs and relative salience in lexical conceptual structure. In T. Kageyama, editor, *Verb semantics and syntactic structure*, pages 45–96. Kurioso Publishers, Tokyo.
- Laura Kallmeyer and Rainer Osswald. 2012a. An Analysis of Directed Motion Expressions with Lexicalized Tree Adjoining Grammars and Frame Semantics. In Luke Ong, editor, *Proceedings of WoLLIC*, Lecture Notes in Computer Science LNCS, September. To appear.
- Laura Kallmeyer and Rainer Osswald. 2012b. A frame-based semantics of the dative alternation in lexicalized tree adjoining grammars. Submitted to *Empirical Issues in Syntax and Semantics 9*.
- Laura Kallmeyer and Maribel Romero. 2008. Scope and situation binding in LTAG using semantic unification. *Research on Language and Computation*, 6(1):3–52.
- Christopher Kennedy and Beth Levin. 2008. Measure of change: The adjectival core of degree achievements. In L. McNally and C. Kennedy, editors, *Adjectives and adverbs. syntax, semantics, and discourse*. Oxford University Press, Oxford.
- Beth Levin and Malka Rappaport Hovav. 1998. Morphology and lexical semantics. In A. Spencer and A. M. Zwicky, editors, *Handbook of morphology*, pages 248–271. Blackwell Publishers, Oxford.
- Rainer Osswald and Robert D. Van Valin, Jr. 2012. Framenet, frame structure, and the syntax-semantics interface. Manuskript Heinrich-Heine Universität.
- Robert D. Van Valin and Randy J. LaPolla. 1997. *Syntax*. Cambridge University Press, Cambridge.