

Sound of Story: Multi-modal Storytelling with Audio

Jaeyeon Bae^{1*} Seokhoon Jeong^{2*} Seokun Kang¹ Namgi Han³
Jae-Yon Lee³ Hyounghun Kim^{1,2} Taehwan Kim^{1,2}

¹Artificial Intelligence Graduate School

²Department of Computer Science and Engineering

³School of Liberal Arts

Ulsan National Institute of Science and Technology, Korea

{qowodussla, shjd0246, oraclemiso, @unist.ac.kr
hng88, jlee2791, h.kim, taehwankim}

Abstract

Storytelling is multi-modal in the real world. When one tells a story, one may use all of the visualizations and sounds along with the story itself. However, prior studies on storytelling datasets and tasks have paid little attention to sound even though sound also conveys meaningful semantics of the story. Therefore, we propose to extend story understanding and telling areas by establishing a new component called *background sound* which is story context-based audio without any linguistic information. For this purpose, we introduce a new dataset, called *Sound of Story (SoS)*, which has paired image and text sequences with corresponding sound or background music for a story. To the best of our knowledge, this is the largest well-curated dataset for storytelling with sound. Our SoS dataset consists of 27,354 stories with 19.6 images per story and 984 hours of speech-decoupled audio such as background music and other sounds. As benchmark tasks for storytelling with sound and the dataset, we propose retrieval tasks between modalities, and audio generation tasks from image-text sequences, introducing strong baselines for them. We believe the proposed dataset and tasks may shed light on the multi-modal understanding of storytelling in terms of sound. Downloading the dataset and baseline codes for each task will be released in the link: https://github.com/Sosdatasets/SoS_Dataset.

1 Introduction

Story understanding and telling is one of the important but challenging problems in natural language processing and machine learning, and there have been extensive studies on this problem for decades (Harrison et al., 2017; Kočíský et al., 2018). Many prior researches have focused on building models that understand stories such as utilizing pre-trained model (Chen et al.,

2022; Wang et al., 2023; He et al., 2023), event-centric understanding (Chen et al., 2021) and using multiway-sampler (Xu et al., 2023). Also, lots of approaches are proposed that aim to understand the stories within the provided text (Mostafazadeh et al., 2016; Fan et al., 2018; Akoury et al., 2020), image (Huang et al., 2016; Bensaid et al., 2021; Krojer et al., 2022) and video (Rohrbach et al., 2015; Xu et al., 2016; Tapaswi et al., 2016; Li et al., 2019; Bain et al., 2020; Huang et al., 2020).

Despite there being many benchmarks for story understanding and telling, most of them less focus on audio even if it is one of the key elements for humans to understand stories (Lang et al., 1998; Lake et al., 2017). Therefore, we propose to extend story understanding and telling areas by establishing a new component called *background sound* which is story context-based audio without any linguistic information. For this purpose, we introduce a novel dataset called the *Sound of Story (SoS)*, which aims to leverage audio information for story understanding, distinguishing it from other existing story or audio datasets.

To create the SoS dataset, all the modalities are extracted from Condensed Movie Dataset (CMD) (Bain et al., 2020) and Large Scale Movie Description Challenge datasets (LSMDC) (Rohrbach et al., 2015). Image and text data extracted from the same movie clip have their contexts and both of them have the possibility to infer the story from the same movie clip. And in the case of audio such as background sound and music, it has the ability to enrich storytelling by representing and recognizing the context of the situations (Eronen et al., 2005; Stowell et al., 2015). Due to these characteristics, audio, image, and text extracted from the same movie clip become correlated and complementary. So, our SoS dataset allows three modalities generated from the same movie clip to be used for story understanding as a pair. In addition, we propose new story under-

* These authors contributed equally to this work.

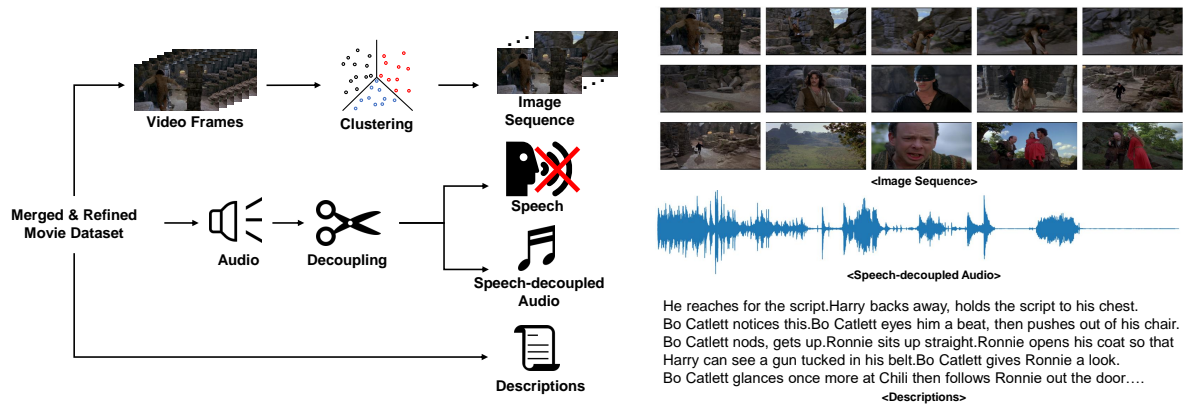

Figure 1: Overall data generating process flow for our Sound of Story (SoS) dataset. All the modalities are extracted from the same movie clips. We exclude the speech from audio to make it contain only pure audio data, which does not contain linguistic information.

standing benchmarks and their baseline models by introducing audio retrieval tasks and audio generation tasks using the SoS dataset.

These background sound tasks can be utilized in various applications. For example, for movies and cartoons, background sound is often produced according to a designated scene using various props or objects for a sense of reality. In the case of the retrieval task, among the sound sources made, it is possible to recommend the sound source which fits the best to the scene. Furthermore, background sound generation can produce more realistic audio while reducing human resource costs by directly generating the right audio for a given scene. The overall data generating process can be shown in Figure 1.

In summary, our contributions are as follows:

- We propose to extend story understanding and telling areas by establishing a new component called *background sound* which is story context-based audio without any linguistic information, which has not been well explored. For this purpose, we introduce a new dataset named *Sound of Story (SoS)* consisting of text and image sequences and audio for a story. To the best of our knowledge, this is the largest well-curated dataset for storytelling with sound.
- As benchmark tasks to show the significance and relevance of sound in a story, we introduce retrieval tasks between audio and other modalities and background sound generation tasks, and baseline models for each of them.
- We will release the dataset and code to gen-

erate them so that the community can generate more data for a variety of tasks to utilize sound in storytelling and story understanding research.

2 Related Work

Story understanding and telling Storytelling tasks pose significant challenges in the domain of natural language processing (NLP), and researchers have proposed various datasets and benchmarks to tackle these problems. Wikiplots, WritingPrompts (Fan et al., 2018), and ROCStories (Mostafazadeh et al., 2016) introduce datasets that revolve around text-based story plots. Wikiplots comprises a collection of approximately 113k story plots extracted from English Wikipedia. WritingPrompts (Fan et al., 2018) assembled their dataset by gathering pairs of human-written stories and corresponding prompts from online sources. ROCStories (Mostafazadeh et al., 2016) employed the use of Amazon Mechanical Turk (AMT) to generate short stories that incorporate common-sense knowledge, with a focus on everyday topics. These datasets are usually used for story understanding or story generation tasks.

In addition to text-based story plots, there exist numerous story datasets that incorporate images or videos. Visual Storytelling (Huang et al., 2016) introduces the first sequential vision-to-language dataset and explores its applicability in various tasks. It goes beyond simple object understanding or captioning for concrete scenes by considering input that encompasses temporal events. Similarly, ImageCoDe dataset (Krojer et al., 2022) also contains stories but is designed to enable models to



Example Clip 1 (CMD)	 <p>Dora parties with her friends over the end credits.</p>
Example Clip 2 (CMD)	 <p>Po's biological father Li shows up at his village.</p>
Example Clip 3 (LSMDC)	 <p>Jackie breaks into tears.They share a helpless half-laugh -- then Frank appears in the doorway.She starts to hand him a large mirror from her purse -- then thinks better of it.But he holds out his hand and she gives him the mirror.Simon holds ...</p>
Example Clip 4 (LSMDC)	 <p>The football coach, the assistants, and Alabama players cheer for Forrest.Forrest runs across the field.He speeds past the defending players.Forrest runs past the opposite players.The football coach runs along the sidelines as he yells. Forrest ...</p>

Figure 2: Example of SoS dataset. CMD and LSMDC have different lengths of descriptions.

learn detailed situations from finer visual differences within similar sets of images.

Movie data inherently encompasses storytelling. Various datasets such as MovieQA (Tapaswi et al., 2016) and MovieNet (Huang et al., 2020) have been collected by using movie data and have been used in various multimodal domains. Additionally, datasets like CMD (Bain et al., 2020) and LSMDC (Liu et al., 2019) not only provide movie videos but also include descriptions for the corresponding clips. This offers researchers an opportunity to explore models from a multimodal perspective. However, there are few datasets for story with sound. Existing benchmarks for audio mostly consist of music (Bertin-Mahieux et al., 2011; Sturm, 2012; Ferraro et al., 2021) or animal/environmental sounds (Salamon et al., 2014; Piczak, 2015; Gemmeke et al., 2017; Kim et al., 2019), and are designed to evaluate simple matching performance between objects (or sentiment) and audio input.

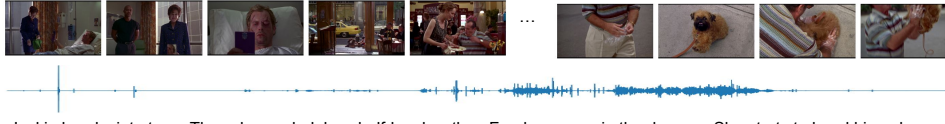
Multi-modal retrieval tasks Multi-modal retrieval models are trained to find similar features across different modalities by fusing. These models are tasked with understanding both the context of a given input and the interplay between features provided by other modalities. As a result, retrieval becomes a highly challenging and crucial task in

order to comprehend the distinctive characteristics of multiple modalities.

The multi-modal retrieval task has been studied using various modalities such as image-text retrieval (Wang et al., 2020; Zhang et al., 2020; Cheng et al., 2022; Luo et al., 2022; Xuan and Chen, 2023), video-text (Ma et al., 2022; Gorti et al., 2022; Zhu et al., 2023), audio-image (Xu, 2020; Yang et al., 2022; Nakatsuka et al., 2023), video-audio (Surís et al., 2018; Gu et al., 2023; Cheng et al., 2023) and audio-text (Kim et al., 2022; Xin et al., 2023). Particularly, CLIP4CLIP (Luo et al., 2022), which performs well in the video-text retrieval task by calculating the similarities between the features of each modality obtained from the encoder, and X-CLIP (Ma et al., 2022) expands CLIP4CLIP and proposes a multi-grained regulation function to improve performance. Furthermore, Wav2CLIP (Wu et al., 2022) conducts retrieval for audio-image modalities based on CLIP architecture (Radford et al., 2021), while CLAP (Elizalde et al., 2023) focuses on audio-text retrieval. In this paper, we propose a story-based audio retrieval task for retrieving proper modal features like image sequences or descriptions.

Multi-modal audio generation There have been prior studies on generating audio by receiving cer-

Dataset	Audio Type	# Story	# Images / Story	# Audio Hours	Avg. text length	Text Type
ImageCode	-	9,402	17	-	23.3	Captions
VIST	-	50,136	4.2	-	10.2	Description
Video Storytelling	open	105	-	22	162.6	Captions
MovieNet	open	1,100	-	633	2004	Description
MSR-VTT	open	10,000	-	41.2	9.6	Description
Ours	speech-decoupled audio	27,354	19.6	984	88	Description

Table 1: Statistics compared to different storytelling datasets. In the audio types, "open" represents raw audio from the video, and "speech-decoupled audio" represents the speech-excluded audio. In the text types, "Caption" represents the text that explains only the image, and "Description" represents the text that includes the story.

tain modality information as input (Vasquez and Lewis, 2019; Yu et al., 2022; Borsos et al., 2022; Neves et al., 2022; Schneider et al., 2023; Yang et al., 2023; Agostinelli et al., 2023). Among several audio generation tasks, recently text-audio generation has been actively studied. AUDIOGEN (Kreuk et al., 2022) uses an augmentation technique that mixes different audio samples when generating audio samples from captions. Riffusion (Forsgren and Martiros, 2022) fine-tunes the model to generate Spectrogram images using the image-to-text based on Stable Diffusion (Rombach et al., 2022). MUSICGEN (Copet et al., 2023) uses a single-stage language model with efficient token interleaving patterns and an unsupervised melody conditioning method. In this paper, we are interested in generating relevant audio given a story.

3 Dataset

We propose a novel dataset named the SoS dataset with 27,354 audio-image-text pairs. 22,330 pairs are created from CMD (Bain et al., 2020) and 5,024 from LSMDC dataset (Rohrbach et al., 2015). We extract the image and audio from the same video and pair them with the description accordingly so that the images and text share the same storyline. In the case of audio, it is related to the other modalities due to being extracted from the same clip so can be used in complementary. The examples of the SoS dataset are shown in Figure 2.

3.1 Movie Clips

CMD (Bain et al., 2020) provides the key clips and their high-level semantic descriptions from 3,605 movies. Each key clip has a duration of around 150 seconds and can be automatically obtained from YouTube, making it easily accessible. LSMDC (Rohrbach et al., 2015) consists of 118,081 short clips extracted from 202 movies. Each clip in LSMDC has a duration of around 3

to 12 seconds and is accompanied by captions generated from Description Video Services (DVS). In our work, we merge these two movie clip datasets to create the audio-image-text paired dataset. To bridge the gap between CMD and LSMDC, we adapt the LSMDC dataset to match the format of CMD. Since the short movie clips in LSMDC are contiguous, we concatenate them in sequential order until their combined length is similar to that of CMD. Specifically, we concatenate around 20 short movie clips together to create the raw movie clip data.

3.2 Audio processing

To facilitate audio processing, we first utilized ffmpeg (Tomar, 2006) to extract audio from the video, ensuring that the length of the extracted audio matched that of the raw movie clip video. Subsequently, we employed the *byteseq* framework proposed by (Kong et al., 2021) to decouple speech from mixed audio containing various sounds. The results of decoupled sounds may be considered as audio data that share the storyline with the raw movie clip video without any linguistic information. Speech-decoupling is proceeded because the speech itself includes the storyline and the model can learn the storyline focused on the speech, not the audio which is not our expectation. Duration distribution of the extracted audios can be seen in Figure 3.

3.3 Image processing

Since videos include many duplicated and similar images, only the key salient images that may represent storyline were extracted through image clustering. We conduct image clustering¹ using image fingerprints, which are representations for uniquely identifying an image generated based on the visual features. From all image fingerprints

¹<https://github.com/elcorto/imagecluster>

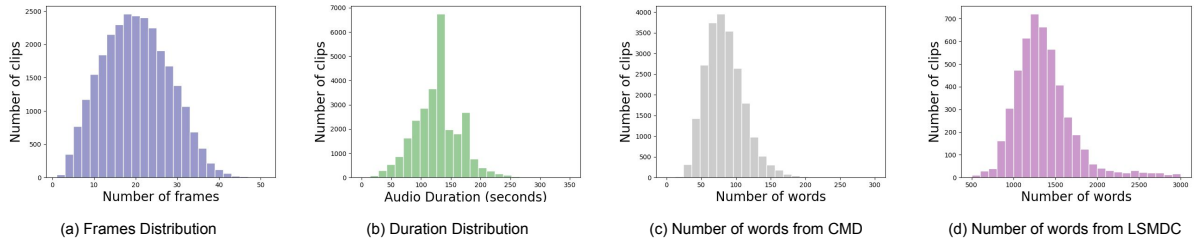

Figure 3: Distributions of each modality. (a) the number of extracted images from a movie video; (b) the duration of decoupled and processed audio for each story (c) the number of words in each story from CMD (d) the number of words in each story from LSMDC. Note that due to video clip concatenation to match video lengths, descriptions have larger lengths for stories from LSMDC. This text variation leads to the model requiring high-level text understanding.

extracted from frames of the movie clips, we gradually removed images with a fingerprint similarity of greater than 0.5 which was set empirically found. Through this process, fewer frames for static and more frames for dynamic scenes could be retained. The extracted image sequences can represent the entire video by capturing salient scenes with significant variations, even though it does not include all of the frames. By utilizing this approach, we can create essential image sequences of the video by focusing on scenes with meaningful changes. These processed image sequences provide a novel dataset that highlights the storyline with fewer frames and differentiates it from traditional video datasets. Figure 3 shows the distribution of extracted frames for each movie clip.

3.4 Text processing

There exist slight differences in clip lengths between CMD and LSMDC even though both of them provide short descriptions for each movie clip. Because we concatenate LSMDC movie clips to match the length of CMD movie clips, descriptions also must be formatted by concatenating the same number of descriptions with the video. As a result, the concatenated descriptions exhibit variations in sentence lengths as in Figure 3.

Furthermore, there are also inherent differences between the two datasets in how the descriptions were generated. CMD utilizes descriptions generated by users from YouTube, while LSMDC employs descriptive video services to generate descriptions. Because of this text variation difference between the two datasets, it makes our task more challenging by requiring high-level text understanding. We can check that the descriptions are well-aligned with other modalities in Figure 2.

3.5 Data Statistics and Analysis

Our SoS dataset is derived from 3,807 movies covered in the CMD and LSMDC datasets, resulting in a total of 27,354 clips. After processing, each clip has an average of 20 images, and the total number of images in our dataset is 535,707. The accumulated length of the extracted audio is around 984 hours, and each audio consists of around 150 seconds on average. Each clip’s text description consists of 88 words on average. If divided into two different datasets, CMD and LSMDC consist of an average of 83.2 words and 1,378.7 words, respectively, with medians of 80 and 130.8, respectively. Quantitative comparison with other story-based datasets is shown in Table 1, and it can be seen that our proposed SoS dataset is the largest well-curated storytelling dataset with extracted audios.

We generate paired decoupled audio data that can be used complementarily for story understanding and telling with the image and text in the SoS dataset. The extracted decoupled audio, which is in-the-wild audio, contains abundant information. Specifically, we decoupled speech information to leave only pure audio consisting of background sound on the audio dataset. These remaining audios contain a mixture of various daily-life sounds and background music. This distinctive characteristic sets it apart from other audio datasets, making it an adequate audio dataset for story understanding.

4 Experiment

4.1 Retrieval Tasks

In this section, we introduce four retrieval tasks: audio-to-video, audio-to-text, text-to-audio, and video-to-audio retrieval using our proposed dataset. The retrieval tasks focus on finding proper audio

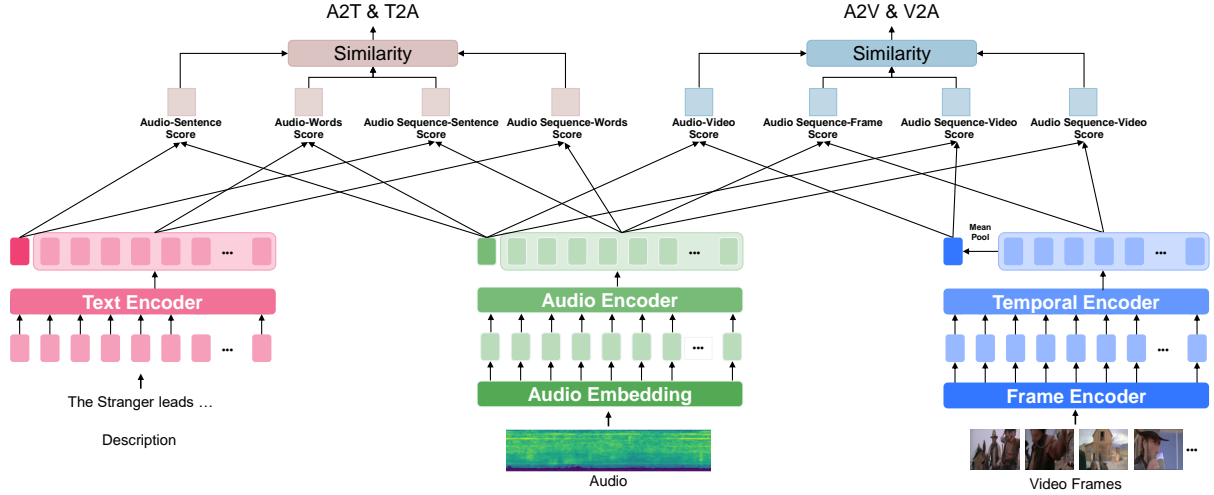

Figure 4: Proposed retrieval model architecture. Encoded features are obtained from the encoder corresponding to each modality. Features are divided into context-level features and sequence-level features. Then we calculate the score for each task and use the score to calculate the final similarity Sim .

corresponding to image sequences or text information containing a story, or matching image sequence or text given audio, which may be used as recommendation for background sound suitable for image sequence or storyline.

4.1.1 Retrieval Model

In this section, we introduce the model used in our proposed retrieval task. We are inspired when we create a baseline model in that the *Attention Over Simplicity Matrix* method proposed by X-CLIP (Ma et al., 2022) can be flexibly applied to Audio as well as Video-Text. Our overall architecture is illustrated in Figure 4.

For descriptions, we use the CLIP text encoder E_T (Radford et al., 2021). The information obtained from the E_t is defined as sentence feature f_s and word feature f_w . In the case of video, the CLIP image encoder E_I is used and the temporal encoder E_t is added to obtain the temporal sequence feature. The obtained feature is defined as frame feature f_f , and the mean pooling of the frame feature is defined as video feature f_v . And in the case of the audio, audio information is extracted by performing audio embedding on Log Mel-filter bank coefficients and fed into the E_A using pretrained Audio Spectrogram Transformer (Gong et al., 2021). In this case, the first token among the acquired feature is defined as audio f_a , and the remaining tokens are defined as audio sequence feature f_{as} .

In the case of audio-video retrieval, we first calculate the similarity between audio-video ($S_{a,v}$), audio-frame ($S_{a,f}$), audio sequence-video ($S_{as,v}$),

and audio sequence-frame ($S_{as,f}$). These similarities are calculated following Equation 1 to 4:

$$S_{a,v} = (f_a)^T (f_v) \in \mathbb{R}^1 \quad (1)$$

$$S_{a,f} = (f_f f_a)^T \in \mathbb{R}^{1 \times m} \quad (2)$$

$$S_{as,v} = f_{as} f_v \in \mathbb{R}^{n \times 1} \quad (3)$$

$$S_{as,f} = (f_{as})(f_f)^T \in \mathbb{R}^{n \times m} \quad (4)$$

where m is the number of video frames and n is the number of audio sequences. Except for audio-video similarity, an aggregation process is required to make it an instance-level similarity. Therefore, the audio-frame and audio sequence-video similarity is calculated through the following equations:

$$S'_{a,f} = \sum_{i=1}^m \frac{\exp(S_{a,f(1,i)})}{\sum_{j=1}^m \exp(S_{a,f(1,j)})} S_{a,f} \quad (5)$$

$$S'_{as,v} = \sum_{i=1}^n \frac{\exp(S_{as,v(i,1)})}{\sum_{j=1}^n \exp(S_{as,v(j,1)})} S_{as,v} \quad (6)$$

The audio-level similarity (S'_{aud}) and video-level similarity (S'_{vid}) are calculated to obtain the audio sequence-frame instance-level similarity:

$$S_{aud} = \sum_{i=1}^n \frac{\exp(S_{as,f(i,*)})}{\sum_{j=1}^n \exp(S_{as,f(j,*)})} S_{as,f(i)} \in \mathbb{R}^{1 \times m} \quad (7)$$

$$S'_{aud} = \sum_{i=1}^m \frac{\exp(S_{aud(1,i)})}{\sum_{j=1}^m \exp(S_{aud(1,j)})} S_{aud(1,i)} \quad (8)$$

$$S_{vid} = \sum_{i=1}^m \frac{\exp(S_{as,f(i,i)})}{\sum_{j=1}^m \exp(S_{as,f(i,j)})} S_{as,f(i)} \in \mathbb{R}^{n \times 1} \quad (9)$$

$$S'_{vid} = \sum_{i=1}^n \frac{\exp(S_{vid(i,1)})}{\sum_{j=1}^n \exp(S_{vid(j,1)})} S_{vid(1,1)} \quad (10)$$

Eval	A2V		V2A		A2T		T2A		Random
	Ours	Wav2CLIP	Ours	Wav2CLIP	Ours	CLAP	Ours	CLAP	
R@1(↑)	7.615	4.231	6.462	5.154	7.462	6.538	7.077	5.769	0.076
R@5(↑)	18.682	12.615	17.923	16.077	17.462	17.231	19.385	16.077	0.378
R@10(↑)	28.000	19.538	27.000	23.462	24.692	24.615	25.692	23.538	0.750
Median R(↓)	40.615	31.231	38.923	33.692	33.000	34.615	32.769	34.385	631.800
Mean R(↓)	32.000	52.000	33.000	47.000	60.000	52.000	63.500	53.500	639.132

Table 2: Retrieval performances with the proposed SoS dataset, which are measured on 1300 test samples. Random means the average of the results of five random retrievals.

where * denotes all elements in that dimension.

In addition, $S'_{as,f}$ are obtained from the means of S'_{aud} and S'_{vid} obtained by Equation 8 and 10. Therefore, the similarity between video and audio is obtained as the average of the obtained similarities, as shown in Equation 11.

$$Sim_{AV} = (S_{a,f} + S'_{a,f} + S'_{as,v} + S'_{as,f})/4 \quad (11)$$

For the audio-text retrieval, the similarity Sim_{AT} can be calculated by replacing video-related features with text-related features.

4.1.2 Implementation Details

Of the 27,354 stories in our SoS dataset, 26,054 are split into train and 1,300 into test sets. In the case of video, a total of 40 images are used as input. At this time, if there are fewer than 40 images, 40 images are filled with duplicate sampling in accordance with the time order, and if there are more than 40, 40 images are obtained by uniform sampling. In the case of audio, the entire audio is used for learning, and random cropping is performed at this time. In the test, the same audio can be used in all tests by cropping and using the information-rich area of the audio. In the case of text, after tokenizing the description with a CLIP tokenizer, we crop 77 tokens from the front and use them similar to other CLIP-based models (Luo et al., 2022; Ma et al., 2022; Li et al., 2023). The batch size is 128 in the audio-video and 256 in the audio-text retrieval task, respectively. We conducted the experiment using 2 NVIDIA A100 80GB GPUs using the PyTorch library for 100 epochs, which took about 20 hours.

4.1.3 Results and Analysis

To evaluate the performance of the proposed baseline model with our SoS dataset, we compare it with Wav2CLIP (Wu et al., 2022) for A2V and V2A, and CLAP (Elizalde et al., 2023) for A2T and T2A. Both Wav2CLIP and CLAP are fine-tuned to our SoS dataset from their pre-trained weights. For the evaluation metrics, we

utilize Recall@1(R@1), Recall@5(R@5), Recall@10(R@10), Mean Rank(Mean R), and Median Rank(Median R). Table 2 shows the performances for audio-to-video (A2V), video-to-audio (V2A), audio-to-text (A2T), and text-to-audio (T2A).

For A2V and V2A, each story of the SoS dataset consists of fairly long image sequences by using clustering from the video which has an average length of 215 seconds, unlike other datasets. In addition, our audio dataset includes various sounds to express a story and thus can better represent storylines compared to audio composed of simple sounds.

However, it also presents greater challenges. Therefore, compared to retrieving tasks using short videos and simple audio, it can be considered a challenging task. Nevertheless, with R@1 of 7.615 and 6.462 for both A2V and V2A, respectively, our baseline model performed better than its comparative model, Wav2CLIP, and showed reasonable evaluation results.

In addition, our text data consists of a storyline that implicitly represents the whole sequence, not a description of the scene, so it is challenging because the model has to understand the context of the scenes rather than a simpler understanding of the scene. Therefore, looking at the R@1 performance 7.462 and 7.077 in A2T and T2A, respectively, the performance of our proposed baseline model is better than the comparison model CLAP. Also, the results of retrievals can be found in our supplementary material or GitHub link ².

4.2 Audio Generation Task

Composing and arranging background music and sound effects that exquisitely match the current scene’s story is a highly challenging task that even human creators struggle (Thom, 1999). We propose an audio generation model called *SoSGen*, which

²https://github.com/Sosdatasets/SoS_Dataset

is designed to generate appropriate audio for the movie scene, given the scene’s descriptions, frames, or both as the condition.

4.2.1 Audio Generation Model

SoSgen takes advantage of the architecture of diffusion models (Sohl-Dickstein et al., 2015), which learn a data distribution through gradual denoising. Stable diffusion models (Rombach et al., 2022), a variant of diffusion models, enable effective model conditioning by training the model to learn latent features. Following the same approach, we train SoSgen as a text-to-audio spectrogram diffusion model, using the following objective function:

$$\mathcal{L} = \mathbb{E}_{x, \epsilon \sim \mathcal{N}(0,1), t, c} [\|\epsilon - \epsilon_{\theta}(\tilde{z}_t, t, c(d))\|_2^2] \quad (12)$$

where c is a trainable CLIP text encoder and d is the SoS description.

For image+text-to-audio training, we follow ControlNet (Zhang and Agrawala, 2023) architecture, a lightweight and powerful method that enables additional conditioning of a diffusion model by freezing the original model’s parameters. We freeze the text-to-audio model’s parameters and resume training using a similar objective function:

$$\mathcal{L} = \mathbb{E}_{x, \epsilon \sim \mathcal{N}(0,1), t, c, c_{img}} [\|\epsilon - \epsilon_{\theta}(\tilde{z}_t, t, c(d), c_{img}(f))\|_2^2] \quad (13)$$

where c_{img} is an additional CLIP image encoder that embeds the SoS frame sequence f .

4.2.2 Implementation Details

Audio in movies rarely remains consistent until the end of a single scene. Also, using long audio as an input or output for a deep learning model is burdening in terms of hardware capacity. Thus, we slice the audio data into a length of approximately 15 seconds. Since extracted frames partially reflect semantic changes within the scene, audio slicing was performed treating audio data between two extracted frames as a base unit. The unit audios are accumulated and concatenated until their cumulative duration exceeds 15 seconds, ensuring that each sliced audio is never longer than 15 seconds. Audios that are originally longer than 15 seconds are not sliced because it implies the absence of significant visual changes for the duration, suggesting a high probability of long, consistent audio. Sliced audio files containing only a little sound were eliminated using the PyDub³ library.

³<https://github.com/jiaaro/pydub>

To this end, we assessed the mean frequency of each segment and excluded any with a frequency below 78 Hz, a threshold determined through manual inspection.

This process conducted 185,341 audio data of roughly 15 seconds each, which were then converted into spectrograms. From this, we randomly split the dataset into 184,462 and 879 as training and testing, respectively.

For our base model, we leveraged Riffusion (Forsgren and Martiros, 2022), a checkpoint of Stable Diffusion v1-5 (Rombach et al., 2022), fine-tuned on pairs of music descriptions and spectrograms. Following the same approach, we fine-tuned the diffusion model from the Riffusion checkpoint with pairs of SoS descriptions and corresponding sliced audio spectrograms. In addition, we further trained the model in the setting of image and text conditioning, utilizing the ControlNet (Zhang and Agrawala, 2023) architecture. We use a sequence of frames extracted through clustering that correspond to the sliced audio as the image condition. SoS_{text+image} was additionally trained from SoS_{text} checkpoint, while SoS_{image} resumed from the Riffusion checkpoint and used a redundant text condition in both training and testing. The specific model architecture can be found in Figure 5.

For training our models, we used a batch size of 1, 16 gradient accumulation steps, an initial learning rate of 1e-6, and a cosine learning rate scheduler. We fine-tuned the text-to-audio model for 406,000 steps and additional 525,000 steps to further train the text+image-to-audio model. Separately, the image-to-audio model was trained for 525,000 steps. We ran fine-tuning for 2 days and ControlNet training for another 2 days on a single NVIDIA GeForce RTX 3090 GPU.

4.2.3 Results and Analysis

Baselines We compare SoSgen to two baselines: Riffusion (Forsgren and Martiros, 2022) and MUSICGEN (Copet et al., 2023), the state-of-the-art open source text-to-music generation model. The performance of the models is evaluated based on the Fréchet Audio Distance (FAD) (Kilgour et al., 2019). FAD is a reference-free evaluation metric that is computed using means and covariances of VGGish (Hershey et al., 2017) embeddings. We used a lightweight pytorch implementation⁴ of FAD for more efficient evaluation.

⁴https://github.com/Sosdatasets/SoS_Dataset

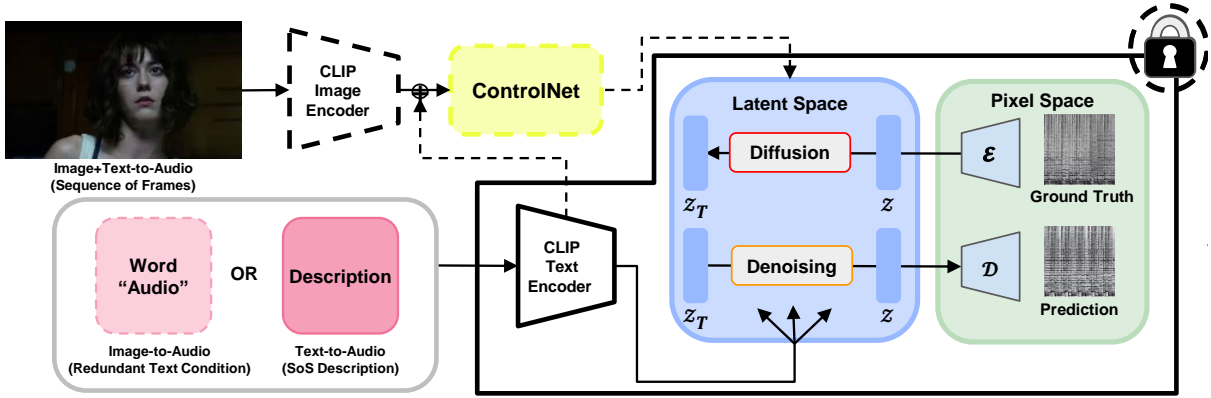

Figure 5: SoSgen architecture for training. The components and arrows drawn with dash lines are only used in the ControlNet-involved training, i.e. image-to-audio and image+text-to-audio. To train a text-to-audio model, we condition the denoising model with CLIP text embeddings of SoS descriptions. Once the text-to-audio model is sufficiently trained, we freeze the model and add image embeddings as a condition to train the text+image-to-audio model using ControlNet. Alternatively, an image-to-audio model can be trained from the Riffusion checkpoint, using a redundant text condition "Audio" for each training data. \mathcal{E} denotes the encoder, \mathcal{D} denotes the decoder, z_T denotes latent representation at timestep T .

Table 3: FAD (lower is better) of SoSgen and the baselines. $\text{SoSgen}_{\text{text+image}}$ is the only model given with the image and text condition. The rest are only given with SoS descriptions as the condition.

Model	$FAD_{VGGish} \downarrow$
Riffusion	20.114
MUSICGEN	11.680
$\text{SoSgen}_{\text{text}}$	10.935
$\text{SoSgen}_{\text{image}}$	18.324
$\text{SoSgen}_{\text{text+image}}$	9.099

Table 3 shows the comparison of SoSgen against Riffusion and MUSICGEN. $\text{SoSgen}_{\text{text}}$, Riffusion, and MUSICGEN generate an audio spectrogram given descriptions. For $\text{SoSgen}_{\text{image}}$ and $\text{SoSgen}_{\text{text+image}}$, an image sequence is also given as an additional condition.

The results indicate that $\text{SoSgen}_{\text{text}}$ and $\text{SoSgen}_{\text{text+image}}$ outperform Riffusion and MUSICGEN in terms of FAD. Although $\text{SoSgen}_{\text{image}}$ only shows a slight improvement from Riffusion, combining two modalities exceptionally enhances audio generation capability. The generated audio samples can be listened to in our GitHub link⁵ and are also included in the supplementary material. The samples show SoSgen’s superior performance on story audio generation tasks.

⁵https://github.com/Sosdatasets/SoS_Dataset

5 Conclusion

In this paper, we emphasize that sound also conveys meaningful semantics of the story. Thus, we propose a novel dataset named Sound of Story (SoS) dataset, audio-image-text pair dataset. One main feature of our dataset is that all the linguistic information inside the audio is eliminated. We named the audio without any linguistic information as "Background sound".

Background sounds can be utilized in various applications and we propose two related tasks, retrieval task and background sound generation task. To give an example of using it from videos such as movies and cartoons, background sound is often produced according to a designated scene using various props or objects for a sense of reality. In the case of the retrieval task, among the different sound sources made, it is possible to recommend the sound source which fits the best to the scene. Furthermore, background sound generation can produce more realistic audio while reducing human resource costs by directly generating the right audio for a given scene. To the best of our knowledge, it is the first attempt to do multimodal tasks with the speech-decoupled background sound relevant to the storyline.

Limitations

To use audio data in story understanding, there are some limitations to be solved. First, we create audio data by decoupling the speech to exclude lin-

guistic information and preserving only pure audio. However, the generated audio may be yet distant from what people encounter in daily life because there is a possibility that various noises caused by the generation from the movie clip remain. Second, the audio-image-text pair is strongly connected, but it is not perfect due to the nature of the audio. Since audio includes a lot of subjective elements, various correct answers may exist for one story. To deal with these limitations, more strict and cautious policies to process not only audio but also image and text for story understanding should continue to be studied as future work.

Ethics Statement

One potential ethical concern from our proposed dataset is the ability of our model to generate audio resembling existing work as it may potentially pose copyright issues such as regarding background music. In addition, generated audio may be too uncomfortable or inappropriate to hear.

Acknowledgements

This work was partly supported by Institute of Information & communications Technology Planning & Evaluation (IITP) grant funded by the Korea government (MSIT) (No.2022-0-00608, Artificial intelligence research about multi-modal interactions for empathetic conversations with humans & No.2021-0-02068, Artificial Intelligence Innovation Hub) and the National Research Foundation of Korea(NRF) grant funded by the Korea government(MSIT) (No. RS-2023-00219959).

References

- Andrea Agostinelli, Timo I Denk, Zalán Borsos, Jesse Engel, Mauro Verzetti, Antoine Caillon, Qingqing Huang, Aren Jansen, Adam Roberts, Marco Tagliasacchi, et al. 2023. Musiclm: Generating music from text. *arXiv preprint arXiv:2301.11325*.
- Nader Akoury, Shufan Wang, Josh Whiting, Stephen Hood, Nanyun Peng, and Mohit Iyyer. 2020. Storium: A dataset and evaluation platform for machine-in-the-loop story generation. *arXiv preprint arXiv:2010.01717*.
- Max Bain, Arsha Nagrani, Andrew Brown, and Andrew Zisserman. 2020. Condensed movies: Story based retrieval with contextual embeddings. In *Proceedings of the Asian Conference on Computer Vision*.
- Eden Bensaïd, Mauro Martino, Benjamin Hoover, and Hendrik Strobelt. 2021. Fairytaylor: A multimodal generative framework for storytelling. *arXiv preprint arXiv:2108.04324*.
- Thierry Bertin-Mahieux, Daniel PW Ellis, Brian Whithman, and Paul Lamere. 2011. The million song dataset.
- Zalán Borsos, Raphaël Marinier, Damien Vincent, Eugene Kharitonov, Olivier Pietquin, Matt Sharifi, Olivier Teboul, David Grangier, Marco Tagliasacchi, and Neil Zeghidour. 2022. Audiolm: a language modeling approach to audio generation. *arXiv preprint arXiv:2209.03143*.
- Muhao Chen, Hongming Zhang, Qiang Ning, Manling Li, Heng Ji, Kathleen McKeown, and Dan Roth. 2021. Event-centric natural language understanding. In *Proceedings of the 59th Annual Meeting of the Association for Computational Linguistics*.
- Xi Chen, Xiao Wang, Soravit Changpinyo, AJ Piergiovanni, Piotr Padlewski, Daniel Salz, Sebastian Goodman, Adam Grycner, Basil Mustafa, Lucas Beyer, et al. 2022. Pali: A jointly-scaled multilingual language-image model. *arXiv preprint arXiv:2209.06794*.
- Xuxin Cheng, Zhihong Zhu, Hongxiang Li, Yaowei Li, and Yuexian Zou. 2023. Ssvmr: Saliency-based self-training for video-music retrieval. In *ICASSP 2023-2023 IEEE International Conference on Acoustics, Speech and Signal Processing (ICASSP)*, pages 1–5. IEEE.
- Yuhao Cheng, Xiaoguang Zhu, Jiuchao Qian, Fei Wen, and Peilin Liu. 2022. Cross-modal graph matching network for image-text retrieval. *ACM Transactions on Multimedia Computing, Communications, and Applications (TOMM)*, 18(4):1–23.
- Jade Copet, Felix Kreuk, Itai Gat, Tal Remez, David Kant, Gabriel Synnaeve, Yossi Adi, and Alexandre Défossez. 2023. Simple and controllable music generation. *arXiv preprint arXiv:2306.05284*.
- Benjamin Elizalde, Soham Deshmukh, Mahmoud Al Ismail, and Huaming Wang. 2023. Clap learning audio concepts from natural language supervision. In *ICASSP 2023-2023 IEEE International Conference on Acoustics, Speech and Signal Processing (ICASSP)*, pages 1–5. IEEE.
- Antti J Eronen, Vesa T Peltonen, Juha T Tuomi, Anssi P Klapuri, Seppo Fagerlund, Timo Sorsa, Gaëtan Lorho, and Jyri Huopaniemi. 2005. Audio-based context recognition. *IEEE Transactions on Audio, Speech, and Language Processing*, 14(1):321–329.
- Angela Fan, Mike Lewis, and Yann Dauphin. 2018. Hierarchical neural story generation. *arXiv preprint arXiv:1805.04833*.
- Andres Ferraro, Yuntae Kim, Soohyeon Lee, Biho Kim, Namjun Jo, Semi Lim, Suyon Lim, Jungtaek Jang, Sehwon Kim, Xavier Serra, et al. 2021. Melon playlist dataset: A public dataset for audio-based playlist

- generation and music tagging. In *ICASSP 2021-2021 IEEE International Conference on Acoustics, Speech and Signal Processing (ICASSP)*, pages 536–540. IEEE.
- Seth* Forsgren and Hayk* Martiros. 2022. [Riffusion - Stable diffusion for real-time music generation](#).
- Jort F Gemmeke, Daniel PW Ellis, Dylan Freedman, Aren Jansen, Wade Lawrence, R Channing Moore, Manoj Plakal, and Marvin Ritter. 2017. Audio set: An ontology and human-labeled dataset for audio events. In *2017 IEEE international conference on acoustics, speech and signal processing (ICASSP)*, pages 776–780. IEEE.
- Yuan Gong, Yu-An Chung, and James Glass. 2021. [AST: Audio Spectrogram Transformer](#). In *Proc. Interspeech 2021*, pages 571–575.
- Satya Krishna Gorti, Noël Vouitsis, Junwei Ma, Keyvan Golestan, Maksims Volkovs, Animesh Garg, and Guangwei Yu. 2022. X-pool: Cross-modal language-video attention for text-video retrieval. In *Proceedings of the IEEE/CVF Conference on Computer Vision and Pattern Recognition*, pages 5006–5015.
- Xin Gu, Yinghua Shen, and Chaohui Lv. 2023. A dual-path cross-modal network for video-music retrieval. *Sensors*, 23(2):805.
- Brent Harrison, Christopher Purdy, and Mark Riedl. 2017. Toward automated story generation with markov chain monte carlo methods and deep neural networks. In *Proceedings of the AAAI Conference on Artificial Intelligence and Interactive Digital Entertainment*, volume 13, pages 191–197.
- Xingjian He, Sihan Chen, Fan Ma, Zhicheng Huang, Xiaojie Jin, Zikang Liu, Dongmei Fu, Yi Yang, Jing Liu, and Jiashi Feng. 2023. Vlab: Enhancing video language pre-training by feature adapting and blending. *arXiv preprint arXiv:2305.13167*.
- Shawn Hershey, Sourish Chaudhuri, Daniel PW Ellis, Jort F Gemmeke, Aren Jansen, R Channing Moore, Manoj Plakal, Devin Platt, Rif A Saurous, Bryan Seybold, et al. 2017. Cnn architectures for large-scale audio classification. In *2017 IEEE international conference on acoustics, speech and signal processing (icassp)*, pages 131–135. IEEE.
- Qingqiu Huang, Yu Xiong, Anyi Rao, Jiaze Wang, and Dahua Lin. 2020. Movienet: A holistic dataset for movie understanding. In *Computer Vision—ECCV 2020: 16th European Conference, Glasgow, UK, August 23–28, 2020, Proceedings, Part IV 16*, pages 709–727. Springer.
- Ting-Hao Huang, Francis Ferraro, Nasrin Mostafazadeh, Ishan Misra, Aishwarya Agrawal, Jacob Devlin, Ross Girshick, Xiaodong He, Pushmeet Kohli, Dhruv Batra, et al. 2016. Visual storytelling. In *Proceedings of the 2016 conference of the North American chapter of the association for computational linguistics: Human language technologies*, pages 1233–1239.
- Kevin Kilgour, Mauricio Zuluaga, Dominik Roblek, and Matthew Sharifi. 2019. Fréchet audio distance: A reference-free metric for evaluating music enhancement algorithms. In *INTERSPEECH*, pages 2350–2354.
- Chris Dongjoo Kim, Byeongchang Kim, Hyunmin Lee, and Gunhee Kim. 2019. Audiocaps: Generating captions for audios in the wild. In *Proceedings of the 2019 Conference of the North American Chapter of the Association for Computational Linguistics: Human Language Technologies, Volume 1 (Long and Short Papers)*, pages 119–132.
- Eungbeom Kim, Jinhee Kim, Yoori Oh, Kyungsu Kim, Minju Park, Jaeheon Sim, Jinwoo Lee, and Kyogu Lee. 2022. Improving audio-language learning with mixgen and multi-level test-time augmentation. *arXiv preprint arXiv:2210.17143*.
- Tomáš Kočiský, Jonathan Schwarz, Phil Blunsom, Chris Dyer, Karl Moritz Hermann, Gábor Melis, and Edward Grefenstette. 2018. The narrativeqa reading comprehension challenge. *Transactions of the Association for Computational Linguistics*, 6:317–328.
- Qiuqiang Kong, Yin Cao, Haohe Liu, Keunwoo Choi, and Yuxuan Wang. 2021. Decoupling magnitude and phase estimation with deep resunet for music source separation. In *ISMIR*. Citeseer.
- Felix Kreuk, Gabriel Synnaeve, Adam Polyak, Uriel Singer, Alexandre Défossez, Jade Copet, Devi Parikh, Yaniv Taigman, and Yossi Adi. 2022. Audiogen: Textually guided audio generation. *arXiv preprint arXiv:2209.15352*.
- Benno Krojer, Vaibhav Adlakha, Vibhav Vineet, Yash Goyal, Edoardo Ponti, and Siva Reddy. 2022. Image retrieval from contextual descriptions. *arXiv preprint arXiv:2203.15867*.
- Brenden M Lake, Tomer D Ullman, Joshua B Tenenbaum, and Samuel J Gershman. 2017. Building machines that learn and think like people. *Behavioral and brain sciences*, 40:e253.
- Peter J Lang, Margaret M Bradley, and Bruce N Cuthbert. 1998. Emotion, motivation, and anxiety: Brain mechanisms and psychophysiology. *Biological psychiatry*, 44(12):1248–1263.
- Junnan Li, Yongkang Wong, Qi Zhao, and Mohan S Kankanhalli. 2019. Video storytelling: Textual summaries for events. *IEEE Transactions on Multimedia*, 22(2):554–565.
- Wei Li, Linchao Zhu, Longyin Wen, and Yi Yang. 2023. Decap: Decoding clip latents for zero-shot captioning via text-only training. *arXiv preprint arXiv:2303.03032*.
- Yang Liu, Samuel Albanie, Arsha Nagrani, and Andrew Zisserman. 2019. Use what you have: Video retrieval using representations from collaborative experts. *arXiv preprint arXiv:1907.13487*.

- Huaishao Luo, Lei Ji, Ming Zhong, Yang Chen, Wen Lei, Nan Duan, and Tianrui Li. 2022. Clip4clip: An empirical study of clip for end to end video clip retrieval and captioning. *Neurocomputing*, 508:293–304.
- Yiwei Ma, Guohai Xu, Xiaoshuai Sun, Ming Yan, Ji Zhang, and Rongrong Ji. 2022. X-clip: End-to-end multi-grained contrastive learning for video-text retrieval. In *Proceedings of the 30th ACM International Conference on Multimedia*, pages 638–647.
- Nasrin Mostafazadeh, Nathanael Chambers, Xiaodong He, Devi Parikh, Dhruv Batra, Lucy Vanderwende, Pushmeet Kohli, and James Allen. 2016. A corpus and cloze evaluation for deeper understanding of commonsense stories. In *Proceedings of the 2016 Conference of the North American Chapter of the Association for Computational Linguistics: Human Language Technologies*, pages 839–849.
- Takayuki Nakatsuka, Masahiro Hamasaki, and Masataka Goto. 2023. Content-based music-image retrieval using self-and cross-modal feature embedding memory. In *Proceedings of the IEEE/CVF Winter Conference on Applications of Computer Vision*, pages 2174–2184.
- Pedro Neves, Jose Fornari, and João Florindo. 2022. Generating music with sentiment using transformer-gans. *arXiv preprint arXiv:2212.11134*.
- Karol J Piczak. 2015. Esc: Dataset for environmental sound classification. In *Proceedings of the 23rd ACM international conference on Multimedia*, pages 1015–1018.
- Alec Radford, Jong Wook Kim, Chris Hallacy, Aditya Ramesh, Gabriel Goh, Sandhini Agarwal, Girish Sastry, Amanda Askell, Pamela Mishkin, Jack Clark, et al. 2021. Learning transferable visual models from natural language supervision. In *International conference on machine learning*, pages 8748–8763. PMLR.
- Anna Rohrbach, Marcus Rohrbach, Niket Tandon, and Bernt Schiele. 2015. A dataset for movie description. In *Proceedings of the IEEE conference on computer vision and pattern recognition*, pages 3202–3212.
- Robin Rombach, Andreas Blattmann, Dominik Lorenz, Patrick Esser, and Björn Ommer. 2022. High-resolution image synthesis with latent diffusion models. In *Proceedings of the IEEE/CVF Conference on Computer Vision and Pattern Recognition*, pages 10684–10695.
- Justin Salamon, Christopher Jacoby, and Juan Pablo Bello. 2014. A dataset and taxonomy for urban sound research. In *Proceedings of the 22nd ACM international conference on Multimedia*, pages 1041–1044.
- Flavio Schneider, Zhijing Jin, and Bernhard Schölkopf. 2023. Mo[^]usai: Text-to-music generation with long-context latent diffusion. *arXiv preprint arXiv:2301.11757*.
- Jascha Sohl-Dickstein, Eric Weiss, Niru Maheswaranathan, and Surya Ganguli. 2015. Deep unsupervised learning using nonequilibrium thermodynamics. In *International Conference on Machine Learning*, pages 2256–2265. PMLR.
- Dan Stowell, Dimitrios Giannoulis, Emmanouil Benetos, Mathieu Lagrange, and Mark D Plumbley. 2015. Detection and classification of acoustic scenes and events. *IEEE Transactions on Multimedia*, 17(10):1733–1746.
- Bob L Sturm. 2012. An analysis of the gtzan music genre dataset. In *Proceedings of the second international ACM workshop on Music information retrieval with user-centered and multimodal strategies*, pages 7–12.
- Didac Surís, Amanda Duarte, Amaia Salvador, Jordi Torres, and Xavier Giró-i Nieto. 2018. Cross-modal embeddings for video and audio retrieval. In *Proceedings of the european conference on computer vision (eccv) workshops*, pages 0–0.
- Makarand Tapaswi, Yukun Zhu, Rainer Stiefelhagen, Antonio Torralba, Raquel Urtasun, and Sanja Fidler. 2016. Movieqa: Understanding stories in movies through question-answering. In *Proceedings of the IEEE conference on computer vision and pattern recognition*, pages 4631–4640.
- Randy Thom. 1999. Designing a movie for sound. *IRIS-PARIS-*, 27:9–20.
- Suramya Tomar. 2006. Converting video formats with ffmpeg. *Linux Journal*, 2006(146):10.
- Sean Vasequez and Mike Lewis. 2019. Melnet: A generative model for audio in the frequency domain. *arXiv preprint arXiv:1906.01083*.
- Sijin Wang, Ruiping Wang, Ziwei Yao, Shiguang Shan, and Xilin Chen. 2020. Cross-modal scene graph matching for relationship-aware image-text retrieval. In *Proceedings of the IEEE/CVF winter conference on applications of computer vision*, pages 1508–1517.
- Wenhui Wang, Hangbo Bao, Li Dong, Johan Bjorck, Zhiliang Peng, Qiang Liu, Kriti Aggarwal, Owais Khan Mohammed, Saksham Singhal, Subhojit Som, et al. 2023. Image as a foreign language: Beit pretraining for vision and vision-language tasks. In *Proceedings of the IEEE/CVF Conference on Computer Vision and Pattern Recognition*, pages 19175–19186.
- Ho-Hsiang Wu, Prem Seetharaman, Kundan Kumar, and Juan Pablo Bello. 2022. Wav2clip: Learning robust audio representations from clip. In *ICASSP 2022-2022 IEEE International Conference on Acoustics, Speech and Signal Processing (ICASSP)*, pages 4563–4567. IEEE.

- Yifei Xin, Dongchao Yang, and Yuexian Zou. 2023. Improving text-audio retrieval by text-aware attention pooling and prior matrix revised loss. In *ICASSP 2023-2023 IEEE International Conference on Acoustics, Speech and Signal Processing (ICASSP)*, pages 1–5. IEEE.
- Hanxiao Xu. 2020. Cross-modal sound-image retrieval based on deep collaborative hashing. In *2020 5th International Conference on Information Science, Computer Technology and Transportation (ISCTT)*, pages 188–197. IEEE.
- Jiaqi Xu, Bo Liu, Yunkuo Chen, Mengli Cheng, and Xing Shi. 2023. Multi: Efficient video-and-language understanding with multiway-sampler and multiple choice modeling. *arXiv preprint arXiv:2303.05707*.
- Jun Xu, Tao Mei, Ting Yao, and Yong Rui. 2016. Msr-vtt: A large video description dataset for bridging video and language. In *Proceedings of the IEEE conference on computer vision and pattern recognition*, pages 5288–5296.
- Hong Xuan and Xi Stephen Chen. 2023. Dissecting deep metric learning losses for image-text retrieval. In *Proceedings of the IEEE/CVF Winter Conference on Applications of Computer Vision*, pages 2164–2173.
- Dongchao Yang, Jianwei Yu, Helin Wang, Wen Wang, Chao Weng, Yuexian Zou, and Dong Yu. 2023. Diffsound: Discrete diffusion model for text-to-sound generation. *IEEE/ACM Transactions on Audio, Speech, and Language Processing*.
- Rui Yang, Shuang Wang, Yingzhi Sun, Huan Zhang, Yu Liao, Yu Gu, Biao Hou, and Licheng Jiao. 2022. Multimodal fusion remote sensing image–audio retrieval. *IEEE Journal of Selected Topics in Applied Earth Observations and Remote Sensing*, 15:6220–6235.
- Botao Yu, Peiling Lu, Rui Wang, Wei Hu, Xu Tan, Wei Ye, Shikun Zhang, Tao Qin, and Tie-Yan Liu. 2022. Museformer: Transformer with fine-and coarse-grained attention for music generation. *arXiv preprint arXiv:2210.10349*.
- Lvmin Zhang and Maneesh Agrawala. 2023. Adding conditional control to text-to-image diffusion models. *arXiv preprint arXiv:2302.05543*.
- Qi Zhang, Zhen Lei, Zhaoxiang Zhang, and Stan Z Li. 2020. Context-aware attention network for image-text retrieval. In *Proceedings of the IEEE/CVF conference on computer vision and pattern recognition*, pages 3536–3545.
- Jinkuan Zhu, Pengpeng Zeng, Lianli Gao, Gongfu Li, Dongliang Liao, and Jinkuan Song. 2023. Complementarity-aware space learning for video-text retrieval. *IEEE Transactions on Circuits and Systems for Video Technology*.