

# One QuantLLM for ALL: Fine-tuning Quantized LLMs Once for Efficient Deployments

Ke Yi<sup>1,2\*</sup> Yuhui Xu<sup>3\*</sup> Heng Chang<sup>4‡</sup> Yuan Meng<sup>4</sup> Tong Zhang<sup>1†</sup> Jia Li<sup>2†</sup>

## Abstract

Large Language Models (LLMs) have advanced rapidly but face significant memory demands. While quantization could alleviate the memory-bound issue, current methods typically require lengthy training to recover accuracy under low bit width. In that circumstance, deployment across scenarios with different resource constraints necessitates repeated training, amplifying the issue of protracted training. It is beneficial to train a once-for-all (OFA) supernet capable of offering optimal subnets for downstream applications. To extend the once-for-all setting to LLMs, we decouple the shared weights to mitigate the interference and integrate Low-Rank adapters to enhance training efficiency. Furthermore, it is observed that there is an imbalance in the allocation of training resources due to traditional uniform sampling. A non-parametric scheduler is introduced to adjust the sampling rate for each quantization configuration, thereby achieving a more balanced allocation among subnets with varying demands. We validate the approach on LLaMA families and Mistral on downstream evaluation, demonstrating high performance while significantly reducing deployment time faced with multiple scenarios.<sup>1</sup>

## 1 Introduction

Large Language Models have shown surprising performance in recent years. However, they suffer from huge storage and computational costs; for example, inference with a LLaMA (Touvron et al., 2023) model with 70B parameters needs at least 280 GB of GPU memory. To further boost the LLMs’ development for fitting diverse scenarios,

recent studies have adopted quantization to compress the model size and reduce the computational costs.

Previous works have conducted extensive exploration on Post-Training Quantization (Frantar et al., 2022; Xiao et al., 2023; Lin et al., 2023)). Under 8-bit quantization, PTQ has achieved negligible accuracy loss. However, compressing models to a lower bit level, for instance, 3-bit, leads to significant degradation in accuracy. Quantization-aware training (QAT) mitigates performance degradation by simulating quantization errors during the training process. However, it is notably more time-consuming. When deploying low-bit LLMs for diverse scenarios with varying resource constraints, repeating quantization-aware training for each scenario is impractical, as shown in Figure 1 (a). From the above analysis, the training dominates the cost of deployments; hence, it would be beneficial to train a once-for-all (OFA) supernet. This supernet can generate optimal subnets with diverse configurations (e.g., quantization bit-width) tailored to specific applications, as shown in Figure 1 (b, c).

To the best of our knowledge, once-for-all quantization-aware training for LLMs has not been investigated, primarily due to the large scale of current language models and the high cost of traditional QAT. Previous research on once-for-all strategies primarily employs a weight-sharing approach to avoid the model size explosion that would result from allocating separate weights for each configuration (Wang et al., 2020; Chen et al., 2021). However, the weight-sharing combined with traditional QAT presents two significant challenges: 1) various quantization configurations share the weight but have different orders of magnitude of quantization noise, resulting in the noteworthy interference problem and optimization challenges (Tang et al., 2024). 2) Traditional QAT is based on full-fine-tuning, combined with the time-consuming process of simulating quantization errors, which is ineffi-

<sup>1</sup>The work was conducted during Ke Yi’s visit to Hong Kong University of Science and Technology - Guangzhou. \* denotes equal contribution. ‡ denotes program leader. † denotes equal advising. <sup>1</sup> South China University of Technology <sup>2</sup> The Hong Kong University of Science and Technology <sup>3</sup> Salesforce AI Research <sup>4</sup> Tsinghua University.

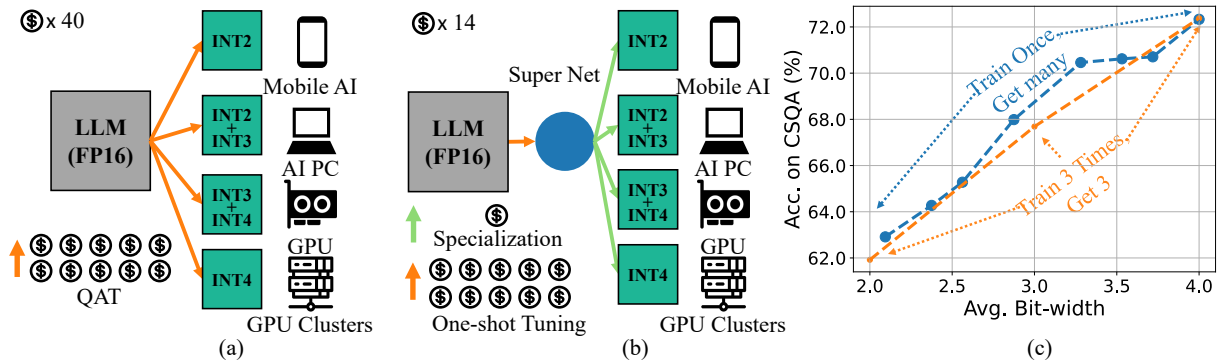

Figure 1: (a) Compressing Large Language Models (LLMs) for deployment across various platforms while ensuring performance is a challenging task. Applying Quantization-Aware Training (QAT) for each platform is both time-consuming and costly. (b) Instead, our objective is to one-shot fine-tune one quantized LLM that can be efficiently specialized for multiple platforms. The one-shot fine-tuning process significantly reduces the investment. (c) The LLM-QFA framework excels in swiftly delivering optimal networks under different resource constraints in one shot, whereas the traditional method requires repeated fine-tuning.

cient even under the weight-sharing scheme.

Furthermore, our observations reveal that the uniform sampling strategy used by traditional OFA methods leads to an imbalance in the allocation of training resources. As illustrated in Figure 3, subnets derived from uniform sampling exhibit a bias toward their average bit-width, which falls into a low variance distribution. Consequently, subnets whose average bit-width deviates from this distribution are prone to under-fitting.

Integrating these aspects, we propose the **LLM-QFA** (Quantization-Aware Fine-tuning one LLM for All scenarios) framework that efficiently fine-tunes a once-for-all supernet to later generate optimal subnets for diverse scenarios. First, we introduce interference-less fine-tuning to decouple the weights of different configurations, accompanied by Low-Rank adapters to enable efficient training. Specifically, we quantize the weights with different quantization configurations and freeze them, then apply Low-Rank adapters to each quantized weight for later fine-tuning. Second, we propose a resource-balanced sampling strategy, which utilizes a non-parametric scheduler that dynamically adjusts the sampling strategy across training steps.

To evaluate our proposed framework, we conduct experiments on LLaMA2 models and validate the performance on the MMLU and Common Sense QA benchmarks. The results show that our proposed framework can yield diverse optimal quantized models for various scenarios. It is worth noting that our framework can be easily scaled up to even larger models since the training time per step is the same as the previous LoRA-tuning (Xu

et al., 2023). We summarize our contributions as follows:

- We first introduce the once-for-all training paradigm for large language models (LLMs), which helps to reduce the training cost for deploying LLMs across diverse scenarios.
- we decouple weights of configurations to mitigate interference issues and incorporate Low-Rank adapters to enhance the training efficiency.
- To address the imbalance training caused by the uniform sampling strategy, we propose a resource-balanced sampling strategy that focuses on providing a fair sampling opportunity across subnets with various resource demands.

## 2 Related Work

**LLM Quantization.** Quantization is a compression technique that reduces the bit-width of weights and/or activations to save memory and accelerate inference. The quantization of LLM can be categorized into two main lines. The first one is post-training quantization (PTQ) (Frantar et al., 2022; Xiao et al., 2023; Lin et al., 2023; Kim et al., 2023), which focuses on reducing the memory footprint without retraining. Although lots of designs are designed to mitigate the degradation of performance, e.g., handling outliers in parameters (Kim et al., 2023; Li et al., 2023a) and dynamic quantization (Xiao et al., 2023; Lin et al., 2023), PTQ still has to drop the ultra-low bit-width (e.g., 2-bit and 3-bit) to guarantee the performance. Hence, the second line,

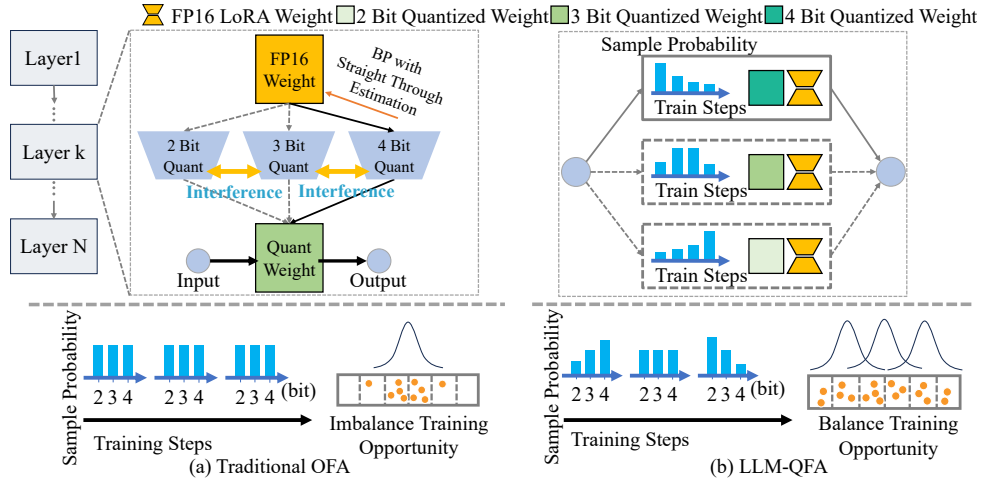

Figure 2: Illustration of the goal of LLM-QFA. Unlike traditional OFA with Quantization-Aware Training, our method avoids interference issues by decoupling shared weights and incorporating the Low-Rank Adapter to enhance training efficiency further. Additionally, we employ a resource-balance sampling strategy, accelerating the convergence of subnets across resource constraints.

Quantization-Aware Training (QAT) can help alleviate the performance drop. The first QAT method applied on LLM (Liu et al., 2023) inherits the idea of traditional QAT, which is computationally expensive in the fine-tuning stage. To reduce the training cost, (Dettmers et al., 2024; Xu et al., 2023; Guo et al., 2023; Li et al., 2023b) utilize LoRA-tuning on quantized weights and gain a decent performance. Specifically, (Xu et al., 2023) adds constraints on LoRA to maintain the quantization property after merging between LoRA weight and quantization weight, which firstly brings LoRA-tuning to actual quantization-aware training. Though LoRA-tuning can save memory footprint and training costs, when faced with diverse development scenarios with different resource constraints, LoRA-tuning still falls into the pitfall of repeated training.

**Once for All training.** Once-for-all training (OFA) methods (Wang et al., 2020; Chen et al., 2021; Yu et al., 2020; Tang et al., 2023, 2022) aim to train a one-shot supernet that can serve diverse scenarios with different resource constraints and save expensive retraining per scenario. On non-LLMs, the success of one-shot training comes from the weight-sharing scheme between different configurations (Chen et al., 2021; Yu et al., 2020), while weight-sharing also brings interference between different bit-widths for quantization-aware training (Tang et al., 2024, 2023). Moreover, traditional OFA with weight sharing necessitates fine-tuning the entire parameters, which is impractical for LLMs due to their extensive size.

### 3 Methodology

#### 3.1 Problem definition

This paper focuses on the dimension of quantization to compress the LLMs for efficient deployment across diverse scenarios, which involves 1) post-training quantization to compress LLMs and 2) constructing the layer-wise mixed-precision supernet based on quantized LLMs and 3) optimizing the supernet.

**Post-training Quantization** To reduce memory cost, it is effective to quantize the pre-trained weight of LLMs in low-bit representation; mathematically, given the bit-width  $N$  and the target weight  $\mathbf{W}$ , the quantization process can be defined as

$$\hat{\mathbf{W}} = \lfloor \frac{\mathbf{W}}{\alpha} \rfloor, \alpha = (\max(|\mathbf{W}|)) / (2^{N-1} - 1), \quad (1)$$

where  $\alpha$  denotes scaling factors.  $\lfloor \cdot \rfloor$  denotes the rounding operation.  $\hat{\mathbf{W}}$  is the quantized weight, and its elements are stored in a set of  $\{0, 1, \dots, 2^N - 1\}$ . Here, only two floating-point numbers and a series of integers are needed for storage and computation memory.

**Layer-wise Mixed-precision Supernet** In contrast to uniform bit-width quantization, mixed-precision quantization, which allows for varying bit-widths across different layers, can yield superior performance by capitalizing on the inherent redundancy in specific layers. In this work, we build a supernet containing different quantization bit-width configurations layer-wise. Each single path of the supernets denotes a mixed-precision LLM, and we aim to optimize all single paths,

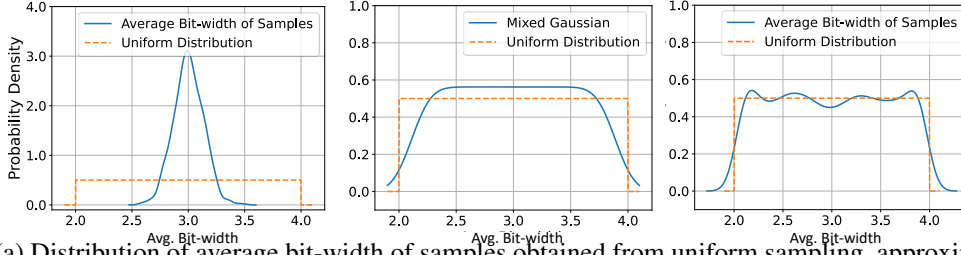

Figure 3: (a) Distribution of average bit-width of samples obtained from uniform sampling, approximating a low variance Gaussian distribution. (b) Mixed Gaussian Distribution can approximate the Uniform Distribution. (c) Showcase of our Resource-Balance sampling strategy.

which can be formulated as

$$\{s_1, s_2, \dots, s_i, \dots, s_{N-1}, s_N\},$$

where  $s_i = [Q_{1,i_1}, Q_{2,i_2}, \dots, Q_{L,i_L}]$ ,

where  $s_i$  denotes one subnet.  $L$  represents the number of layers in the large model. We quantize the model into  $N$  different quantization bit-widths, denoted as  $\mathbf{B} = \{b_1, b_2, \dots, b_N\}$ .  $Q_{l,i}$  represent the quantized  $l$ -th layer with bit-width  $b_i$ . We apply quantization to the pre-trained weight  $\mathbf{W}$  with 2, 3, 4 bit-width quantization. Hence, the quantity of subnets in the space is  $3^L$ . Our target is to 1) optimize all the subnets at once and 2) offer optimal subnets under given resource constraints.

### 3.2 One-Shot Optimization

**Interference-Less Fine-tuning.** We have observed that previous one-shot training methodologies (Cai et al., 2019; Yu et al., 2020) gained success from their weight-sharing scheme, which avoids large model sizes caused by saving the weight of each configuration. However, the weight-sharing scheme also brings interference problems, as shown in Figure 2 (a).

$$\mathbf{Y}_l = \mathbf{X} \cdot \alpha_l \cdot \lfloor \frac{\mathbf{W}}{\alpha_l} \rfloor,$$

$$\frac{\partial \sum_{l=1}^L \text{Loss}_l}{\partial \mathbf{W}} = \sum_{l=1}^L \left( \frac{\partial \text{Loss}_l}{\partial \mathbf{Y}_l} \cdot \mathbf{X} \cdot \alpha_l \cdot \frac{\partial \lfloor \frac{\mathbf{W}}{\alpha_l} \rfloor}{\partial \mathbf{W}} \right),$$

where  $l$  denotes different quantization settings, and  $\mathbf{Y}_l$  varies for different quantization error. Specifically, high and low bit-widths have different quantization noise, and significantly superimposed quantization noise leads to optimization challenges (Tang et al., 2024).

To alleviate interference between different configurations, the straightforward approach is to decouple shared weights and assign weights for each configuration. Hence, we incorporate low-rank adapters to represent each quantization configuration, which only brings negligible extra costs compared with the size of LLMs, as shown in Figure 2 (b). Specifically, the forward process can be defined as:

$$\mathbf{Y} = \mathbf{X} \cdot \alpha_l \cdot \lfloor \frac{\mathbf{W}}{\alpha_l} \rfloor + \mathbf{B}_l \mathbf{A}_l \cdot \mathbf{X}, \quad \frac{\partial \text{Loss}_l}{\partial \mathbf{B}_l \mathbf{A}_l} = \mathbf{X} \cdot \frac{\partial \text{Loss}_l}{\partial \mathbf{Y}_l}, \quad (2)$$

where  $\mathbf{A}_l, \mathbf{B}_l$  denotes the weight of Low-Rank adapters for  $l_{th}$  quantization configuration. It is noteworthy that a low-rank adapter is updated solely for one quantization setting, which is crucial for avoiding interference among different configurations.

To avoid heterogeneity between float-point LoRA weights and quantized weights, which hinders the acceleration for inference, we follow QA-LoRA (Xu et al., 2023) to add constraints on adapters' weights for preserving the quantization property after merging.

Integrating the above designs, the task of optimizing all subnets can be formulated as

$$\min_{\mathbf{W}_L} \sum_{a_i} \mathcal{L}_{val}(f(\mathbf{W}_L, \mathbf{W}_Q, a_i)), \quad (3)$$

where  $f(\mathbf{W}_L, \mathbf{W}_Q, a_i)$  denotes the process that forms a sub-network according to architectural configuration  $a_i$  and inherits corresponding quantization weight  $W_Q$  and LoRA weight  $W_L$ .

**Resource-Balance Sampling Strategy.** Fine-tuning all the subnets is a multi-objective problem. Given the impracticality of enumerating and tuning every subnet at each training iteration, a simplistic yet sub-optimal approach is to uniformly sample a few subnets from the configuration space for fine-tuning. Specifically, each layer has a uniform probability of choosing one quantization configuration, which can be formulated as  $\mathbf{P}(Q_{l,i}) = \frac{1}{N}$ .

Though it seems fair, the naive uniform sampling strategy is biased toward subnets whose average bit-width is close to its expected value. Assume variable  $q_i$  as the quantization bit-width for  $i_{th}$  layer. Variables  $[q_1, q_2, \dots, q_L]$  are independent; hence the average of bit-width can be formulated as:

$$\text{Var}[Bit(s)] = \text{Var}\left[\frac{\sum_{i=1}^L q_i}{L}\right] = \frac{1}{L^2} \sum_{i=1}^L \text{Var}[q_i] = \frac{\sigma^2}{L}, \quad (4)$$

where the  $Bit(s)$  denotes the average bit-width of the sampled and  $\sigma^2$  denotes the variance of  $q_i$ . As shown in Figure 3 (a), the distribution of  $Bit(s)$  is close to a normal distribution, where the variance is

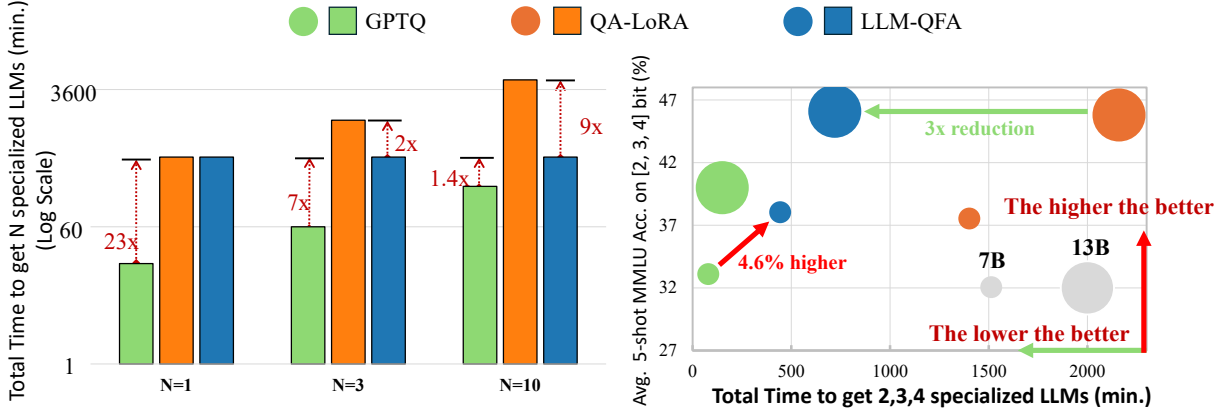

Figure 4: Left: The time required to obtain  $N$  specialized networks varies across methods. Our proposed QFA approach significantly reduces the time cost compared to the QA-LoRA method and achieves a comparable efficiency level to the pure quantization technique, GPTQ. Right: For each method, we obtain three specialized networks under (2, 3, 4) bit constraints on the LLaMA2-7b and LLaMA2-13B models. The average accuracy on the 5-shot MMLU benchmark for networks quantized at (2, 3, 4) bits is reported. Although GPTQ can achieve a lower time cost, it is accompanied by an unacceptable level of performance degradation. Full results are provided in Table 1.

extremely small when  $L = 32$ . Hence, the subnet with an average bit-width far from the distribution center would get unbalanced training resources.

Revealed by Figure 3 (b), straightforwardly stacking normal distributions with different means can approximate a uniform distribution for  $Bit(s)$  and alleviate the imbalance problem. From the implementation perspective, a mixed Gaussian distribution can be achieved by setting different sampling strategies for configurations across training steps. The process can be formulated as

$$E[Bit(s, t)] = (b_N - b_1) \cdot 2 \cdot \frac{t}{SL} - 1 + b_1, \quad (5)$$

where  $SL$  is the length of one schedule epoch.  $b_N$  represents the maximum bit-width and  $b_1$  denotes the minimum bit-width. Within one schedule, the mean of distribution would move from  $b_N$  to  $b_1$  and then back to  $b_N$ , leading to a smooth switchover between schedule epochs. Compared to the uniform sampling strategy, our approach prevents bias on subnets in median size. Therefore, the subnet space converges more efficiently, as shown in Figure 3 (c), which makes the following search process more effective.

### 3.3 Search Optimized Subnet

We decouple the fine-tuning process and the searching process. No extra retraining cost is needed when finding the optimal subnet under the given resource constraint. The searching process starts with random searching, where a few subnets are sampled. Then, correlation analysis between the

subnets' performance on the validation set and the quantization bit-width of each layer is conducted. Learning from the correlation, the sensitivity of each layer to the quantization bit-width can be obtained, and the search space can be further narrowed down. Finally, we further sample subnets from the narrowed search space, and the final optimal subnet is selected based on the performance of the validation set.

## 4 Experiments

### 4.1 Settings

**Models and Quantization.** We conduct experiments on LLMs, LLaMA2-7b, LLaMA2-13b, and Mistral. The quantization is based on GPTQ (Frantar et al., 2022) with 2, 3, 4 bit-width quantization. The detailed quantization configuration, e.g., group size and order, is consistent with QA-LoRA (Xu et al., 2023).

**Datasets and Training Details.** We fine-tune models with Alpaca (Taori et al., 2023), which contains 52K instruction-following data generated from GPT 3.5 (Wang et al., 2022). The length of one schedule epoch is 8k training steps. Following previous works (Dettmers et al., 2024; Xu et al., 2023), we use a paged AdamW optimizer with a batch size 16 and a learning rate of  $2 \times 10^{-5}$ . The training process is conducted on one A100 GPU, and only 8 GPU hours are needed to fine-tune one LLaMA2-7B-based supernet with 10K steps.

**Evaluation.** We evaluate the performance of the models on MMLU (Hendrycks et al., 2021)

Table 1: 0-shot and 5-shot accuracy (%) on the Massive Multitask Language Understanding (MMLU) dataset. Each block is based on the same foundation model specified in the first row. For each method, we present the metrics achieved under the bit-width resource constraints of 2, 3, 4, as well as the corresponding averages.

Method	Bit Const.	MMLU (0-shot)					MMLU (5-shot)				
		Hums.	STEM	Social	Other	Avg.	Hums.	STEM	Social	Other	Avg.
LLaMA2-7B	16	48.3	35.2	48.8	45.8	43.6	51.6	37.3	52.2	49.9	46.8
GPTQ	4	40.4	33.7	45.9	42.2	39.9	50.5	36.9	50.5	47.5	45.1
GPTQ	3	28.8	25.8	25.6	28.0	27.0	31.6	28.2	25.6	32.9	30.7
GPTQ	2	23.8	23.7	22.5	23.8	23.5	24.3	23.0	23.9	26.1	24.2
GPTQ	Avg.					30.1					33.3
QA-LoRA	4	49.7	37.5	51.4	47.8	45.7	49.8	36.8	49.8	47.8	45.1
QA-LoRA	3	43.3	33.7	44.8	42.9	40.5	40.2	34.8	44.1	40.8	39.5
QA-LoRA	2	32.6	27.2	35.6	33.2	31.7	27.2	26.9	29.0	30.5	28.3
QA-LoRA	Avg.					39.3					37.6
LLM-QFA	4	50.3	37.4	49.8	46.8	45.2	48.4	35.6	48.1	46.9	44.0
LLM-QFA	3	42.3	34.4	48.1	42.9	41.2	41.4	33.3	46.2	41.2	39.8
LLM-QFA	2	33.7	28.7	36.3	32.9	32.5	28.8	28.2	32.5	30.5	29.8
LLM-QFA	Avg.					39.6					37.9
LLaMA2-13B	16	56.9	42.4	61.0	55.6	52.8	62.9	44.4	63.9	56.7	55.7
GPTQ	4	55.3	41.6	58.1	53.3	51.1	61.3	43.3	62.5	57.2	54.9
GPTQ	3	42.0	31.8	43.6	41.3	39.0	41.4	36.5	46.7	43.7	41.5
GPTQ	2	25.0	22.4	22.3	24.4	23.5	23.8	23.4	22.6	24.9	23.7
GPTQ	Avg.					37.9					40.0
QA-LoRA	4	56.9	41.5	60.4	54.9	52.3	59.6	42.7	62.2	57.4	54.2
QA-LoRA	3	54.0	40.0	57.1	52.5	49.9	56.8	41.9	59.0	53.5	51.7
QA-LoRA	2	32.6	28.9	31.4	35.3	31.8	30.3	28.2	34.4	36.5	32.0
QA-LoRA	Avg.					44.7					46.0
LLM-QFA	4	57.4	41.3	60.4	55.8	52.5	59.1	42.1	61.1	56.2	53.4
LLM-QFA	3	56.3	40.3	58.8	54.6	51.3	56.7	40.6	59.9	54.5	51.8
LLM-QFA	2	34.5	30.3	33.0	37.3	33.5	32.2	28.5	36.0	37.2	33.1
LLM-QFA	Avg.					45.8					46.1

and Common Sense QA benchmarks. The MMLU dataset contains four categories: Humanities, STEM, Social, and Other. The Common Sense QA benchmarks include HellaSwag (Zellers et al., 2019), PIQA (Bisk et al., 2020), WinoGrande (Sakaguchi et al., 2021), ARC-e, ARC-c (Clark et al., 2018), BoolQ (Clark et al., 2019), and OBQA (Mihaylov et al., 2018). For the MMLU Benchmark, we search for the optimal subnets on the MMLU evaluation dataset. Initially, we sampled the first 100 subnets randomly and subsequently employed a shrinkage strategy to sample an additional 50 subnets, denoted as [100, 50]. For the Common Sense QA datasets, we similarly searched for optimal subnets on the ARC-C dataset with [100, 50] setting. We report the 0-shot and 5-shot accuracy on MMLU and 5-shot accuracy on Common Sense QA benchmarks.

## 4.2 Main Results

**Comparisons with on MMLU.** Figure 4 reports the comparison between LLM-QFA and Quantization-Aware training methods (QA-LoRA) and the Post-Training Quantization method (GPTQ) under (2, 3, 4) bit-widths. **LLM-QFA** demonstrates significantly higher efficiency than QA-LoRA faced with multiple deployment scenarios. This advantage stems from the training cost associated with LLM-QFA remaining constant, in contrast to the methods that scale linearly with the number of deployment scenarios  $N$ . Although our approach incurs a modestly higher time cost than GPTQ, the substantial performance degradation observed in GPTQ is unacceptable. Table 1 illustrates that, despite delivering only comparable performance under the 4-bit constraint, the average metrics of our method across (2, 3, 4) bit constraints consistently surpass those of QA-LoRA and GPTQ, without the need for costly repeated training.

Table 2: 5-shot accuracy (%) on the Common Sense QA tasks. Each block is based on the same foundation model specified in the first row. We organize all results under different quantization bit widths. Mixed precision configurations are searched on ARC-C, and the best configurations are tested on the rest of the Common Sense QA tasks.

Method	Bit Const.	Eval							
		ARC-C	HellaSwag	PIQA	WinoGrande	ARC-e	BoolQ	OBQA	Avg.
LLaMA2-7B	16	52.0	78.2	80.1	74.1	81.1	79.3	45.2	73.0
GPTQ	4	50.8	77.0	79.5	73.8	80.2	74.1	43.4	71.3
QA-LoRA	4	55.5	79.0	80.0	73.3	79.6	75.9	46.4	<b>72.4</b>
<b>LLM-QFA</b>	4	53.8	76.8	79.3	73.5	78.1	77.4	49.0	72.4
GPTQ	3	30.1	49.9	68.3	59.3	55.5	44.3	35.0	52.1
QA-LoRA	3	47.8	72.4	75.0	68.4	73.6	72.0	44.8	67.7
<b>LLM-QFA</b>	3	49.1	72.3	76.7	69.0	73.8	72.8	43.4	<b>68.0</b>
GPTQ	2	25.8	26.2	51.1	50.6	26.0	41.7	25.0	36.8
QA-LoRA	2	40.4	65.6	73.6	62.0	66.0	65.9	37.2	<b>61.7</b>
<b>LLM-QFA</b>	2	43.1	64.8	73.2	62.2	67.0	64.3	38.8	61.7
LLaMA2-13B	16	57.5	81.7	81.7	76.0	84.4	83.2	48.2	75.9
GPTQ	4	56.5	81.1	80.9	75.6	83.3	81.7	47.4	75.0
QA-LoRA	4	58.0	79.2	81.3	74.0	83.3	83.8	49.4	75.2
<b>LLM-QFA</b>	4	56.0	79.6	82.0	73.2	83.5	83.2	51.0	<b>75.4</b>
GPTQ	3	47.8	68.6	77.7	67.9	77.1	71.9	42.8	67.7
QA-LoRA	3	53.5	67.0	79.4	66.7	80.1	76.3	41.8	68.5
<b>LLM-QFA</b>	3	53.7	75.1	79.7	70.3	80.5	78.4	48.0	<b>72.0</b>
GPTQ	2	27.8	25.8	50.2	50.2	26.6	37.8	23.4	35.7
QA-LoRA	2	49.1	70.8	76.6	66.4	76.1	74.1	44.8	68.1
<b>LLM-QFA</b>	2	49.2	70.9	77.0	67.2	76.3	74.3	44.6	<b>68.4</b>
Mistral-7B	/	64.3	84.1	84.4	78.9	84.9	86.0	50.6	78.1
GPTQ	4	62.3	78.2	80.3	78.8	83.9	85.1	49.6	76.0
QA-LoRA	4	57.8	79.7	83.1	76.3	83.3	85.2	48.6	76.0
<b>LLM-QFA</b>	4	58.3	78.7	83.3	76.1	83.2	86.0	49.2	<b>76.1</b>
GPTQ	3	56.7	74.5	78.5	73.0	81.5	84.7	48.4	73.4
QA-LoRA	3	57.1	77.0	80.6	74.0	80.7	84.5	47.8	74.1
<b>LLM-QFA</b>	3	58.1	76.1	81.2	74.4	82.2	84.6	49.0	<b>74.6</b>
GPTQ	2	24.4	40.5	64.2	49.7	38.8	61.1	24.8	46.5
QA-LoRA	2	30.0	47.5	66.3	53.1	52.5	63.4	30.0	52.1
<b>LLM-QFA</b>	2	37.3	52.5	69.4	60.0	63.8	66.2	30.2	<b>57.0</b>

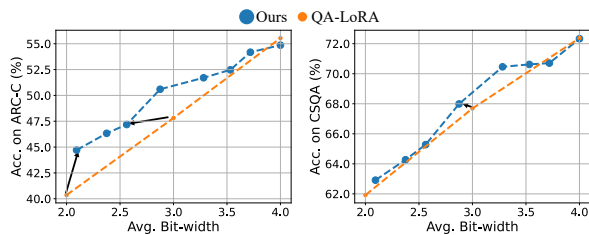

Figure 5: **LLM-QFA** can deliver multiple optimal subsets under different constraints. Left: Comparison of the ARC-C dataset; Right: Comparison of the rest of the Common Sense QA tasks.

**Comparisons on Common Sense QA** We conduct the experiment on Common Sense QA with LLaMA families and Mistral as shown in Table 2. Consistent with the findings from the MMLU benchmark, LLM-QFA demonstrates comparable performance with baselines at extreme bit-width (2,

4) and outperforms at median bit-width (3). The advantage is significant with LLaMA2-13B under 3-bit constraints, where LLM-QFA gains 3.5% accuracy improvement over QA-LoRA.

**LLM-QFA under Different Resource Constraints.** Figure 5 summarizes the results of LLM-QFA under different bit-width constraints. LLM-QFA achieves 45.0% ARC-C accuracy with 2.1 average bit-width, being 5% more accurate than QA-LoRA with similar resource demands. Compared with QA-LoRA at 3-bit, our approach can achieve the same level of performance with fewer resources, a 1.2x reduction on ARC-C, and a 1.1x reduction on the rest of Common Sense QA.

**Impact of Mixed Precision and Quality of Optimization.** Previous results have shown signif-

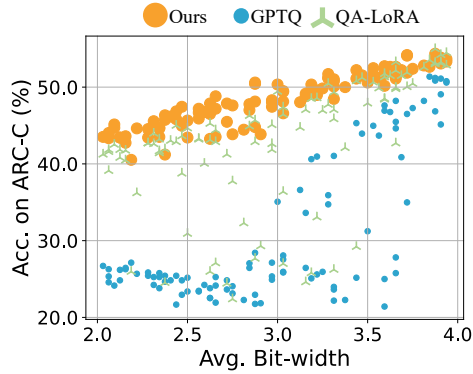

Figure 6: Subnets sampled from LLM-QFA show significant robustness over baselines with simple mixed-precision.

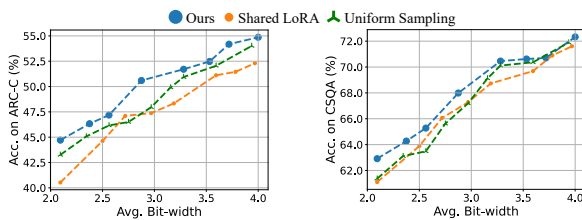

Figure 7: Verification of the effectiveness of Interference-Less Fine-Tuning and Resource-Balance Sampling Strategy.

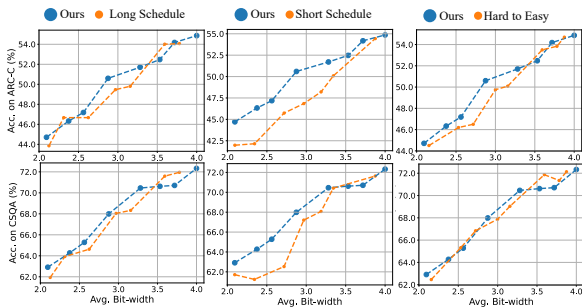

Figure 8: Common Sense QA accuracy (%) of LLM-QFA with different scheduler settings.

icant performance improvement in the median resource constraints. To ensure the gains are not solely due to mixed precision, we sampled 100 mixed-precision configurations for both GPTQ and QA-LoRA and evaluated them on the ARC-C dataset. To be noticed, we evaluate mixed-precision QA-LoRA based on the fine-tuned QA-LoRA weight at (2, 3, 4) bits. Figure 6 demonstrates that it performs more robustly across varying resource demands, further validating that our method can help optimize all the subnets, not just benefiting from mixed precision. Although the mixed-precision version of QA-LoRA exhibits a modest improvement in performance at higher bit-widths, it incurs a threefold increase in training time to achieve these results. Moreover, the observed performance instability suggests a potential

loss of optimal subnet configurations under certain constraints.

### 4.3 Ablation Study

**Ablation on Interference-Less Fine-tuning.** To assess the effectiveness of decoupling shared weights, we introduce a variant called shared-LoRA, wherein different quantization settings share the same Low-Rank adapter. Figure 7 reports that shared-LoRA underperforms the original version across all resource demands, validating the interference problem in one-shot LLM training.

**Ablation on Resource-Balance Sampling.** Similarly, we implement a uniform sampling version of our method. Figure 7 also shows a consistently under-performing uniform sampling strategy; even the resource-concentrated area (3 bit) falls short in the comparison. This has motivated the development of a resource-balanced sampling strategy for training, which is designed to counteract the challenges of under-fitting and over-fitting encountered in one-shot training.

**Ablation for Scheduler.** Lastly, we investigate two aspects of configuration for the scheduler, which are the length of epochs (SL) and schedule orders. In our main experiments, the epoch length is set to 8k training steps. For the short-term schedule, it is reduced to 1k steps, while for the long-term schedule, it is extended to 16k steps. Figure 8 demonstrates that the short-term diminishes robustness and hinders convergence, particularly at lower bit configurations. Regarding the scheduled orders, we initiate our training with 4-bit configurations, employing an easy-to-hard strategy. In this part, we assess the hard-to-easy setting. Figure 8 demonstrates that the order has a negligible impact.

## 5 Conclusion

This work introduces the **LLM-QFA** framework, a once-for-all Quantization-Aware training approach to reduce the training cost of deploying large language models (LLMs) across diverse scenarios. By decoupling the weights of different configurations and incorporating Low-Rank adapters, we enhance training efficiency and mitigate interference issues. A resource-balanced sampling strategy ensures fair training across subnets with various resource demands. Our experiments show that **LLM-QFA** delivers optimal quantized models, demonstrating its effectiveness.



## 6 Acknowledgments

This work was supported by Guangdong S&T Program C019 and South China University of Technology Foundation (x2js-B920015a and x2js-B5222240). This work was also funded in part by the National Natural Science Foundation of China grant under number 62222603, in part by the STI2030-Major Projects grant from the Ministry of Science and Technology of the People’s Republic of China under number 2021ZD0200700, in part by the Key-Area Research and Development Program of Guangdong Province under number 2023B0303030001, in part by the Program for Guangdong Introducing Innovative and Entrepreneurial Teams (2019ZT08X214), and in part by the Science and Technology Program of Guangzhou under number 2024A04J6310. The authors especially thank Chen Tang for the constructive discussions and insightful suggestions.

## 7 Limitations

For bit-width exceeding 4 bits, the quantization method becomes lossless. For bit-width less than 2 bits, there is a significant loss in accuracy. Consequently, the mixed-precision setting is not flexible and can only be selected from 2, 3, and 4 bits. Moreover, the current 2-bit quantization still suffers from remarkable accuracy loss even when equipped with LoRA tuning. The quantization error causes troubles in employment and training, and an orthogonal approach is needed to alleviate the quantization error.

## References

Yonatan Bisk, Rowan Zellers, Jianfeng Gao, Yejin Choi, et al. 2020. Piqa: Reasoning about physical commonsense in natural language. In *Proceedings of the AAAI conference on artificial intelligence*, volume 34, pages 7432–7439.

Han Cai, Chuang Gan, Tianzhe Wang, Zhekai Zhang, and Song Han. 2019. Once-for-all: Train one network and specialize it for efficient deployment. *arXiv preprint arXiv:1908.09791*.

Minghao Chen, Houwen Peng, Jianlong Fu, and Haibin Ling. 2021. Autoformer: Searching transformers for visual recognition. In *Proceedings of the IEEE/CVF international conference on computer vision*, pages 12270–12280.

Christopher Clark, Kenton Lee, Ming-Wei Chang, Tom Kwiatkowski, Michael Collins, and Kristina Toutanova. 2019. BoolQ: Exploring the surprising

difficulty of natural yes/no questions. *arXiv preprint arXiv:1905.10044*.

Peter Clark, Isaac Cowhey, Oren Etzioni, Tushar Khot, Ashish Sabharwal, Carissa Schoenick, and Oyvind Tafjord. 2018. Think you have solved question answering? try arc, the ai2 reasoning challenge. *arXiv preprint arXiv:1803.05457*.

Tim Dettmers, Artidoro Pagnoni, Ari Holtzman, and Luke Zettlemoyer. 2024. Qlora: Efficient finetuning of quantized llms. *Advances in Neural Information Processing Systems*, 36.

Elias Frantar, Saleh Ashkboos, Torsten Hoefler, and Dan Alistarh. 2022. Gptq: Accurate post-training quantization for generative pre-trained transformers. *arXiv preprint arXiv:2210.17323*.

Han Guo, Philip Greengard, Eric P Xing, and Yoon Kim. 2023. Lq-lora: Low-rank plus quantized matrix decomposition for efficient language model finetuning. *arXiv preprint arXiv:2311.12023*.

Dan Hendrycks, Collin Burns, Steven Basart, Andy Zou, Mantas Mazeika, Dawn Song, and Jacob Steinhardt. 2021. Measuring massive multitask language understanding. In *International Conference on Learning Representations*.

Sehoon Kim, Coleman Hooper, Amir Gholami, Zhen Dong, Xiuyu Li, Sheng Shen, Michael W Mahoney, and Kurt Keutzer. 2023. Squeezellm: Dense-and-sparse quantization. *arXiv preprint arXiv:2306.07629*.

Shiyao Li, Xuefei Ning, Ke Hong, Tengxuan Liu, Lun-ying Wang, Xiuhong Li, Kai Zhong, Guohao Dai, Huazhong Yang, and Yu Wang. 2023a. Llm-mq: Mixed-precision quantization for efficient llm deployment. *Efficient Natural Language and Speech Processing Workshop at Advances in Neural Information Processing Systems*.

Yixiao Li, Yifan Yu, Chen Liang, Pengcheng He, Nikos Karampatziakis, Weizhu Chen, and Tuo Zhao. 2023b. Loftq: Lora-fine-tuning-aware quantization for large language models. *arXiv preprint arXiv:2310.08659*.

Ji Lin, Jiaming Tang, Haotian Tang, Shang Yang, Xingyu Dang, and Song Han. 2023. Awq: Activation-aware weight quantization for llm compression and acceleration. *arXiv preprint arXiv:2306.00978*.

Zechun Liu, Barlas Oguz, Changsheng Zhao, Ernie Chang, Pierre Stock, Yashar Mehdad, Yangyang Shi, Raghuraman Krishnamoorthi, and Vikas Chandra. 2023. Llm-qat: Data-free quantization aware training for large language models. *arXiv preprint arXiv:2305.17888*.

Todor Mihaylov, Peter Clark, Tushar Khot, and Ashish Sabharwal. 2018. Can a suit of armor conduct electricity? a new dataset for open book question answering. In *EMNLP*.

- Keisuke Sakaguchi, Ronan Le Bras, Chandra Bhagavatula, and Yejin Choi. 2021. Winogrande: An adversarial winograd schema challenge at scale. *Communications of the ACM*, 64(9):99–106.
- Chen Tang, Yuan Meng, Jiacheng Jiang, Shuzhao Xie, Rongwei Lu, Xinzhu Ma, Zhi Wang, and Wenwu Zhu. 2024. Retraining-free model quantization via one-shot weight-coupling learning. *arXiv preprint arXiv:2401.01543*.
- Chen Tang, Haoyu Zhai, Kai Ouyang, Zhi Wang, Yifei Zhu, and Wenwu Zhu. 2022. Arbitrary bit-width network: A joint layer-wise quantization and adaptive inference approach. In *Proceedings of the 30th ACM International Conference on Multimedia*, pages 2899–2908.
- Chen Tang, Li Lina Zhang, Huiqiang Jiang, Jiahang Xu, Ting Cao, Quanlu Zhang, Yuqing Yang, Zhi Wang, and Mao Yang. 2023. Elasticvit: Conflict-aware supernet training for deploying fast vision transformer on diverse mobile devices. In *Proceedings of the IEEE/CVF International Conference on Computer Vision*, pages 5829–5840.
- Rohan Taori, Ishaan Gulrajani, Tianyi Zhang, Yann Dubois, Xuechen Li, Carlos Guestrin, Percy Liang, and Tatsunori B. Hashimoto. 2023. Stanford alpaca: An instruction-following llama model. [https://github.com/tatsu-lab/stanford\\_alpaca](https://github.com/tatsu-lab/stanford_alpaca).
- Hugo Touvron, Thibaut Lavril, Gautier Izacard, Xavier Martinet, Marie-Anne Lachaux, Timothée Lacroix, Baptiste Rozière, Naman Goyal, Eric Hambro, Faisal Azhar, et al. 2023. Llama: Open and efficient foundation language models. *arXiv preprint arXiv:2302.13971*.
- Hanrui Wang, Zhanghao Wu, Zhijian Liu, Han Cai, Ligeng Zhu, Chuang Gan, and Song Han. 2020. Hat: Hardware-aware transformers for efficient natural language processing. *arXiv preprint arXiv:2005.14187*.
- Yizhong Wang, Yeganeh Kordi, Swaroop Mishra, Alisa Liu, Noah A Smith, Daniel Khashabi, and Hananeh Hajishirzi. 2022. Self-instruct: Aligning language model with self generated instructions. *arXiv preprint arXiv:2212.10560*.
- Guangxuan Xiao, Ji Lin, Mickael Seznec, Hao Wu, Julien Demouth, and Song Han. 2023. Smoothquant: Accurate and efficient post-training quantization for large language models. In *International Conference on Machine Learning*, pages 38087–38099. PMLR.
- Yuhui Xu, Lingxi Xie, Xiaotao Gu, Xin Chen, Heng Chang, Hengheng Zhang, Zhensu Chen, Xiaopeng Zhang, and Qi Tian. 2023. Qa-lora: Quantization-aware low-rank adaptation of large language models. *arXiv preprint arXiv:2309.14717*.
- Jiahui Yu, Pengchong Jin, Hanxiao Liu, Gabriel Bender, Pieter-Jan Kindermans, Mingxing Tan, Thomas Huang, Xiaodan Song, Ruoming Pang, and Quoc Le. 2020. Bignas: Scaling up neural architecture search with big single-stage models. In *Computer Vision—ECCV 2020: 16th European Conference, Glasgow, UK, August 23–28, 2020, Proceedings, Part VII 16*, pages 702–717. Springer.
- Rowan Zellers, Ari Holtzman, Yonatan Bisk, Ali Farhadi, and Yejin Choi. 2019. Hellaswag: Can a machine really finish your sentence? *arXiv preprint arXiv:1905.07830*.