

Phonological Analysis in Typed Feature Systems

Steven Bird*
University of Edinburgh

Ewan Klein*
University of Edinburgh

Research on constraint-based grammar frameworks has focused on syntax and semantics largely to the exclusion of phonology. Likewise, current developments in phonology have generally ignored the technical and linguistic innovations available in these frameworks. In this paper we suggest some strategies for reuniting phonology and the rest of grammar in the context of a uniform constraint formalism. We explain why this is a desirable goal, and we present some conservative extensions to current practice in computational linguistics and in nonlinear phonology that we believe are necessary and sufficient for achieving this goal.

We begin by exploring the application of typed feature logic to phonology and propose a system of prosodic types. Next, taking HPSG as an exemplar of the grammar frameworks we have in mind, we show how the phonology attribute can be enriched so that it can encode multi-tiered, hierarchical phonological representations. Finally, we exemplify the approach in some detail for the nonconcatenative morphology of Sierra Miwok and for schwa alternation in French. The approach taken in this paper lends itself particularly well to capturing phonological generalizations in terms of high-level prosodic constraints.

1. Phonology in Constraint-Based Grammar

Classical generative phonology is couched within the same set of assumptions that dominated standard transformational grammar. Despite some claims that “derivations based on ordered rules (that is, external ordering) and incorporating intermediate structures are essential to phonology” (Bromberger and Halle 1989:52), much recent work has tended toward a new model, frequently described in terms of constraints on well-formedness (Paradis 1988; Goldsmith 1993; McCarthy and Prince 1993; Prince and Smolensky 1993). While this work has an increasingly declarative flavor, most versions retain procedural devices for repairing representations that fail to meet certain constraints, or for constraints to override each other. This view is in marked contrast to the interpretation of constraints in grammar frameworks like LFG, GPSG, and HPSG¹ and in constraint programming systems more generally (Jaffar and Lassez 1987; Smolka 1992). In such approaches, constraints cannot be circumvented, there are no ‘intermediate structures,’ and the well-formedness constraint (Partee 1979) is observed (i.e. ill-formed representations can never be created). The advantage of these frameworks is that they allow interesting linguistic analyses to be encoded while remaining computationally tractable.

* University of Edinburgh, Centre for Cognitive Science, 2 Buccleuch Place, Edinburgh EH8 9LW, U.K.
E-mail: steven.ewan@cogni.ed.ac.uk

¹ Lexical Functional Grammar (Kaplan and Bresnan 1982), Generalized Phrase Structure Grammar (Gazdar, Klein, Pullum, and Sag 1985), and Head-Driven Phrase Structure Grammar (Pollard and Sag 1987).

Here, we are interested in the question of what a theory of phonology ought to look like if it is to be compatible with a constraint-based grammar framework. This issue has already received attention,² although a thoroughgoing integration of phonology into constraint-based grammars has yet to be attempted. To ease exposition, we shall take HPSG as a suitably representative candidate of such approaches. Although we are broadly committed to a sign-oriented approach to grammar, none of our proposals depends crucially on specific tenets of HPSG.

Rather than attempting to theorize at an abstract level about constraint-based phonology, we shall engage in two case studies intended to give a concrete illustration of important issues: these involve templatic morphology in Sierra Miwok and schwa alternation in French. Before launching into these studies, however, we present an overview of some aspects of phonology that present a challenge to standard assumptions taken in sign-oriented constraint-based grammars. Then we describe a (simplified) version of HPSG that will make it possible to illustrate the approach without irrelevant technical machinery.

1.1 The Challenge of Phonology

Given that the dominant focus of most research in constraint-based grammar has been syntax and semantics, it is not surprising that the phonological content of words and phrases has been largely limited to orthographic strings, supplemented with a concatenation operation. How far would such representations have to be enriched if we wanted to accommodate a more thoroughgoing treatment of phonology?

As remarked earlier, recent work in theoretical phonology has apparently moved closer to a constraint-based perspective, and is thus a promising starting point for our investigation. Yet there are at least three challenges that confront anyone looking into theoretical phonology from the viewpoint of computational linguistics. Most striking perhaps is the relative informality of the language in which theoretical statements are couched. Bird and Ladd (1991) have catalogued several examples of this: notational ambiguity (incoherence), definition by example (informality), variable interpretation of notation depending on subjective criteria (inconsistency), and uncertainty about empirical content (indeterminacy). When a clear theoretical statement can be found, it is usually expressed in procedural terms, which clouds the empirical ramifications making a theory difficult to falsify. Finally, even when explicit and nonprocedural generalizations are found, they are commonly stated in a nonlinear model, which clearly goes beyond the assumptions about phonology made in HPSG as it currently stands.

We approach these challenges by adopting a formal, nonprocedural, nonlinear model of phonology and showing how it can be integrated into HPSG, following on the heels of recent work by the authors (Bird and Klein 1990; Bird 1992; Klein 1992). One of the starting assumptions of this work is that phonological representations are intensional, i.e. each representation is actually a *description* of a class of utterances. Derivations progress by refining descriptions, further constraining the class of denoted objects. Lexical representations are likewise partial, and phonological constraints are cast as generalizations in a lexical inheritance hierarchy or in a prosodic inheritance hierarchy. When set against the background of constraint-based grammar, this intensional approach is quite natural (cf. Johnson [1988]). Moreover, some recent thinking on the phonology-phonetics interface supports this view (Pierrehumbert 1990; Coleman

2 (Bach and Wheeler 1981; Wheeler 1981; Bird 1990; Cahill 1990; Coleman 1991; Scobbie 1991; Bird 1992; Walther 1992; Mastroianni 1993; Russell 1993)

1992). However, it represents a fundamental split with the generative tradition, where rules do not so much refine descriptions as alter the objects themselves (Keating 1984).

While it is clearly possible to integrate an essentially generative model into the mold of constraint-based grammar (Krieger, Pirker, and Nerbonne 1993), it is less clear that this is the approach most phonologists would wish to take nowadays. It is becoming increasingly apparent that rule-based relationships between surface forms and hypothetical lexical forms are unable to capture important generalizations about surface forms. This concern was voiced early in the history of generative phonology, when Kisseberth (1970) complained that such rules regularly *conspire* to achieve particular surface configurations, but are unable to express the most elementary observations about what those surface configurations are. As a criticism of rule-based systems, Kisseberth's complaint remains valid and has been echoed several times since then (Shibatani 1973; Hooper 1976; Hudson 1980; Manaster Ramer 1981). However, recent work in phonology has moved away from models involving rules that relate lexical and surface forms toward models involving general systems of interacting constraints, where this problem has been side-stepped.

Accordingly, we avoid the theoretical framework of early generative phonology, focusing instead on encoding phonological *constraints* in a *constraint-based* grammar framework. We present an overview of the grammar framework in the next section.

1.2 Motivation

At this point, we should briefly address the question: What is gained by integrating phonology into a constraint-based grammar? One pragmatic answer is that approaches like HPSG have already taken this step, by introducing a PHONOLOGY attribute that parallels attributes for SYNTAX and SEMANTICS. Since, as we have already pointed out, the value of PHONOLOGY needs to be enriched somehow if it is to be linguistically adequate, it is reasonable to ask whether the formalism allows insightful statements of phonological generalizations.

An objection might take the following form: phonology is formally less complex than syntax, as shown by the body of work on finite state analyses of phonology (cf. Section 1.4). Hence, it is inappropriate to encode phonology in a general purpose formalism that has been designed to accommodate more complex phenomena. As a first response, we would maintain that formalisms should not be confused with theories. Certainly, we want to have a restrictive theory of phonology and its interactions with other levels of grammar. But we view constraint-based formalisms as languages for expressing such theories, not as theories themselves. Moreover, the fact that we use a uniform constraint formalism does not force us to use homogeneous inferential mechanisms for that formalism; this issue is discussed further in Section 1.4 and Section 6.

A further question might be: do natural language grammars require the kind of interaction between phonology and other levels of grammar made possible by constraint-based formalisms? This is not the place to explore this issue in the detail it deserves. However, even if we accept the contention of Pullum and Zwicky (1984) that the interactions between phonology and syntax (narrowly construed) are highly restricted, there are still good reasons for wanting to accommodate phonological representations as one of the constraints in a sign-based grammar framework.

To begin with, it is relatively uncontroversial that morphology needs to be interfaced with both syntax and phonology. Approaches like that of Krieger and Nerbonne (in press) have shown that both derivational and inflectional morphology can be usefully expressed within the constraint-based paradigm. Taking the further step of adding phonology seems equally desirable.

Second, the use of typed feature structures within the lexicon has been strongly

argued for by Briscoe (1991) and Copestake et al. (in press). That is, even when we ignore syntactic combination, constraint-based grammar frameworks turn out to be well suited to expressing the category and semantic information fields of lexical entries. But the interaction of phonology with categorial information inside the lexicon is well documented. Lexical phonology (Kiparsky 1982) has shown in detail how phonological phenomena are conditioned by morphologically specified domains. If direct interaction between phonology and morpho-syntax is prohibited, one can only resort to ad hoc and poorly motivated diacritic features.

Turning to a different empirical domain, it can be argued that focus constructions exhibit an interaction between information structure (at the semantic–pragmatic level) with prosodic structure (at the phonological level). This interaction can be directly expressed in a sign-oriented approach. In other frameworks it is common practice to avoid direct reference to phonology by invoking a morpho-syntactic FOCUS feature (e.g. Selkirk 1984; Rooth 1985); the mediation of syntax in this way appears to be more an artifact of the grammar architecture than an independently motivated requirement. Equally, it has been argued that the phenomenon of heavy NP shift is a kind of syntax-phonology interaction that is simply stated in a constraint-based approach, where the linear precedence constraints of syntax are sensitive to the phonological category of weight (Bird 1992).

1.3 Theoretical Framework

Typed feature structures (Carpenter 1992) impose a type discipline on constraint-based grammar formalisms. A partial ordering over the types gives rise to an inheritance hierarchy of constraints. As Emele and Zajac (1990) point out, this object-oriented approach brings a number of advantages to grammar writing, such as a high level of abstraction, inferential capacity and modularity.

On the face of it, such benefits should extend beyond syntax—to phonology for example. Although there have been some valuable efforts to exploit inheritance and type hierarchies within phonology (e.g. Reinhard and Gibbon 1991), the potential of typed feature structures for this area has barely been scratched so far. In this section, we present a brief overview of HPSG (Pollard and Sag 1987), a constraint-based grammar formalism built around a type system that suits our purposes in phonology.

In order to formulate the type system of our grammar, we need to make two kinds of TYPE DECLARATION. The first kind contains information about the subsumption ordering over types. For example, the basic grammar object in HPSG is the feature structure of type *sign*. The type *sign* has some SUBTYPES. If σ is a subtype of τ , then σ provides at least as much information as τ . A type declaration for *sign* defines it as the following disjunction of subtypes:³

Example 1

$sign \Rightarrow morph \vee stem \vee word \vee phrase$

The second kind of declaration is an APPROPRIATENESS CONDITION. That is, for each type, we declare (all and only) the attributes for which it is specified, and additionally the types of values which those attributes can take.⁴ For example, objects of type *sign*

³ The constraints proposed here deviate in various respects from the standard version of HPSG. We follow Carpenter (1992) in using the notation $\sigma \Rightarrow \phi$ to specify that type σ satisfies constraint ϕ .

⁴ We are using what Carpenter (1992) calls TOTAL WELL-TYPING. That is, (i) the only attributes and values that can be specified for a given feature structure of type τ are those appropriate for τ ; and (ii) every feature structure of type τ must be specified for all attributes appropriate for τ .

could be constrained to have the following features defined:

Example 2

$$\text{sign} \left[\begin{array}{l} \text{PHON} : \textit{phon} \\ \text{SYNSEM} : \textit{synsem} \\ \text{DTRS} : \textit{list} \end{array} \right]$$

That is, feature structures of type *sign* must contain the attributes PHON (i.e. phonology), SYNSEM (i.e. syntax/semantics),⁵ and DTRS (i.e. daughters) and these attributes must take values of a specific type (i.e., *phon*, *synsem*, and *list*, respectively). A further crucial point is that appropriateness conditions are inherited by subtypes. For example, since *morph* is a subtype of *sign*, it inherits all the constraints obeyed by *sign*. Moreover, as we shall see in Section 3.2, it is subject to some further appropriateness conditions that are not imposed on any of its supertypes.

Continuing in the same vein, we can assign appropriateness conditions to the types *synsem* and *phon* that occurred as values in (2), (simplifying substantially from standard HPSG). Here we give the constraints for *synsem*. The type *phon* will be discussed in Section 2.

Example 3

$$\text{synsem} \left[\begin{array}{l} \text{CAT} : \textit{cat} \\ \text{AGR} : \textit{agr} \\ \text{SUBCAT} : \textit{list} \\ \text{SEM} : \textit{semantics} \end{array} \right]$$

To conclude this section, we shall look very briefly at matters of interpretation and inference. As shown by Carpenter (1992) and Zajac (1992, in press), we can use constraint resolution to carry out type inference for feature terms. Following Zajac, let us say that a GROUND feature term is a term all of whose type symbols are minimal (i.e., the most specific types in the hierarchy immediately above \perp). A WELL-TYPED feature term is one that obeys all the type definitions. Then the meaning of a feature term *F* is given by the set of all well-typed ground feature terms that are subsumed by *F*. Evaluating *F*, construed as a query, involves describing *F*'s denotation; for example, enumerating all the well-typed ground feature terms it subsumes. Since the type definitions obeyed by *F* might be recursive, its denotation is potentially infinite. Consider for example the following definitions (where '*nelist*' and '*elist*' stand for nonempty list and empty list respectively, and \top subsumes every type):

Example 4

a. $\textit{list} \Rightarrow \textit{nelist} \vee \textit{elist}$

b. $\textit{nelist} \left[\begin{array}{l} \text{FIRST} : \top \\ \text{REST} : \textit{list} \end{array} \right]$

⁵ Earlier versions of HPSG kept syntax and semantics as separate attributes, and we shall sometimes revert to the latter when borrowing examples from other people's presentations.

Here, the denotation of the type symbol *list* is the set of all possible ground lists. In practice, a constraint solver could recursively enumerate all these solutions; an alternative proposed by Zajac would be to treat the symbol LIST as the best finite approximation of the infinite set of all lists.

1.4 Finite-State Phonology

Over the last decade much has been written on the application of finite-state transducers (FSTs) to phonology, centering on the TWO-LEVEL MODEL of Koskenniemi (1983). Antworth (1990) and Sproat (1992) give comprehensive introductions to the field. The formalism is an attractive computational model for 1960s generative phonology. However, as has already been noted, phonologists have since moved away from complex string rewriting systems to a range of so-called nonlinear models of phonology. The central innovation of this more recent work is the idea that phonological representations are not strings but collections of strings, synchronized like an orchestral score.

There have been some notable recent attempts to rescue the FST model from its linearity in order to encompass nonlinear phonology (Kay 1987; Kornai 1991; Wiebe 1992). However, from our perspective, these refinements to the FST model still admit unwarranted operations on phonological representations, as well as rule conspiracies and the like. Rather, we believe a more constrained and linguistically appealing approach is to employ finite-state automata (FSAs) in preference to FSTs, since it has been shown how FSAs can encode autosegmental representations and a variety of constraints on those representations (Bird and Ellison 1994). The leading idea in this work is that each tier is a partial description of a string, and tiers are put together using the intersection operation defined on FSAs.

Apart from being truer to current phonological theorizing, this one-level model has a second important advantage over the two-level model. Since the set of FSAs forms a Boolean lattice under intersection, union, and complement (a direct consequence of the standard closure properties for regular languages), we can safely conjoin ('unify'), disjoin, and negate phonological descriptions. Such a framework is obviously compatible with constraint-based grammar formalisms, and there is no reason in principle to prevent us from augmenting HPSG with the data type of regular expressions. In practice, we are not aware of any existing implementations of HPSG (or other feature-based grammars) that accommodate regular expressions. Ideally, we would envisage a computational interpretation of typed feature structures where operations on regular expression values are delegated to a specialized engine that manipulates the corresponding FSAs and returns regular expression results.⁶ This issue is discussed further in Section 6.

1.5 Overview of the Paper

The structure of the paper is as follows. In the next section, we present our assumptions about phonological representations and phenomena, couched in the framework of typed feature logic. In Section 3 we discuss our view of the lexicon, borrowing heavily on HPSG's lexical type hierarchy, and developing some operations and representations needed for morphology. The next two sections investigate various applications of the approach to two rather differing phenomena, namely Sierra Miwok templatic morphology and French schwa. Section 6 discusses some implementation issues. The paper concludes with a summary and a discussion of future prospects.

⁶ A similar approach is envisaged by Krieger, Pirker, and Nerbonne (1993).

2. String-Based Phonology

In this section we present a string-based phonology based on the HPSG list notation. We present the approach in Section 2.1 and Section 2.2, concluding in Section 2.3 with a discussion of prosodic constituency.

2.1 List Notations

As a concession to existing practice in HPSG, we have taken the step of using lists in place of strings. We shall use angle bracket notation as syntactic sugar for the standard FIRST/REST encoding.

We shall assume that the type system allows parameterized types of the form $list(\alpha)$, where α is an atomic type.

Example 5

$list(\alpha) \Rightarrow elist(\alpha) \vee nelist(\alpha)$

$$nelist(\alpha) \left[\begin{array}{l} \text{FIRST} : \alpha \\ \text{REST} : list(\alpha) \end{array} \right]$$

We can now treat α^* and α^+ as abbreviations for $list(\alpha)$ and $nelist(\alpha)$ respectively.

Another useful abbreviatory notation is parenthesized elements within lists. We shall interpret $\langle a(b) \rangle \frown L$, a list consisting of an a followed by an optional b concatenated with an arbitrary list L , as the following constraint:

Example 6

$$list \left[\begin{array}{l} \text{FIRST} : a \\ \text{REST} : list \left[\begin{array}{l} \text{FIRST} : b \\ \text{REST} : L \end{array} \right] \vee L \end{array} \right]$$

We shall see applications of these list notations in the next section.

2.2 A Prosodic Type Hierarchy

A PROSODIC TYPE HIERARCHY is a subsumption network akin to the lexical hierarchy of HPSG (Pollard and Sag 1987). The type constraints we have met so far can be used to define a type hierarchy, which for present purposes will be a Boolean lattice. In this section we present in outline form a prosodic hierarchy that subsequent analyses will be based on. Example (7) defines the high-level types in the hierarchy.

Example 7

$phon \Rightarrow utterance \vee phrase \vee foot \vee syl \vee segment$

Each of these types may have further structure. For example, following Clements (1985:248) we may wish to classify segments in terms of their place and manner of articulation, using the following appropriateness declaration.

Example 8

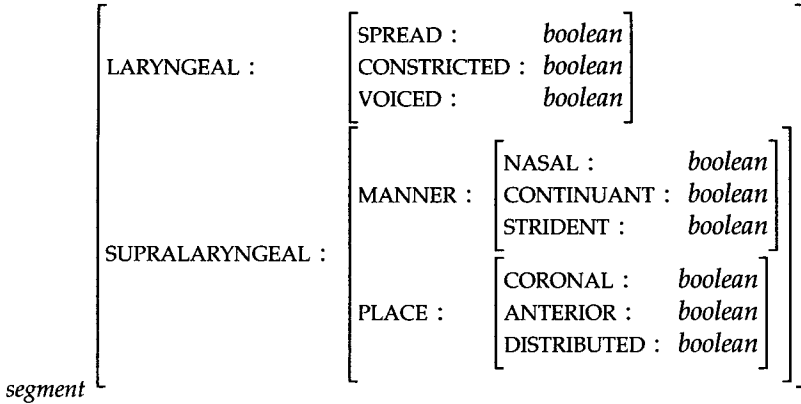

Suppose now that we wished to use these structures in a constraint for English homorganic nasal assimilation. This phenomenon does not occur across phonological phrase boundaries and so the constraint will be part of the definition of the type (phonological) *phrase*. Let us assume that a *phrase* is equivalent to *segment**, i.e. a list of *segments*. Informally speaking, we would like to impose a negative filter that bars any nasal whose value for place of articulation differs from that of the stop consonant that immediately follows. Here, we use SL as an abbreviation for SUPRALARYNGEAL, CONT for CONTINUANT, MN for MANNER, and PL for PLACE.

Example 9

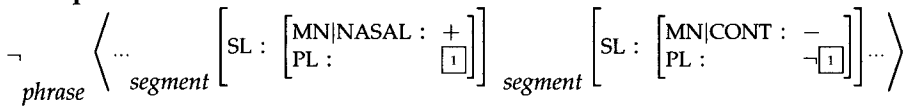

While the abbreviatory conventions in this filter might appear suspicious, it is straightforwardly translated into the constraint in (10). This constraint is divided into three parts. The first simply requires that *hna* be a subtype of *list(segment)*. The second part is lifted from (9), ensuring that the first two positions in the list do not violate the assimilation constraint. The third part propagates the assimilation constraint to the rest of the list.

Example 10

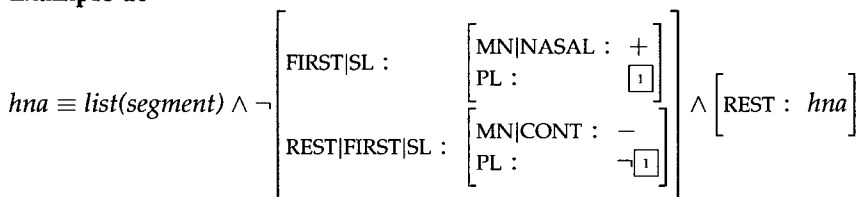

Standard techniques can now be used to move the negation in (10) inward.⁷ Since constraints on adjacent list elements generally seem to be more intelligible in the format exhibited by (9), we shall stick to that notation in the remainder of the paper.

2.3 Prosodic Constituency

One standard phonological approach assumes that prosodic constituency is like phrase structure (Selkirk 1984). For example, one might use a rewrite rule to define a (phonological) phrase as a sequence of feet, and a foot as sequence of syllables:

Example 11

- a. $phrase \rightarrow foot^+$
 b. $foot \rightarrow syl^+$

Within the framework of HPSG, it would be simple to mimic such constituency by admitting a feature structure of type *phrase* whose DTRS (i.e. daughters) are a list of feature structures of type *foot*, and so on down the hierarchy. However, there appears to be no linguistic motivation for building such structure. Rather, we would like to say that a *phrase* is just a nonempty list of feet. But a *foot* is just a list of syllables, and if we abandon hierarchical structure (e.g. by viewing lists as strings), we seem to be stuck with the conclusion that phrases are also just lists of syllables. In a sense this is indeed the conclusion that we want. However, not any list of syllables will constitute a phrase, and not every phrase will be a foot. That is, although the data structure may be the same in each case, there will be additional constraints that have to be satisfied. For example, we might insist that elements at the periphery of phrases are exempt from certain sandhi phenomena; and similarly, that feet have no more than three syllables, and only certain combinations of heavy and light syllables are permissible. Thus, we shall arrive at a scheme like the following, where the C_i indicate the extra constraints:⁸

Example 12

- a. $phrase \equiv foot^+ \wedge C_1 \wedge \dots \wedge C_k$
 b. $foot \equiv syl^+ \wedge C_l \wedge \dots \wedge C_n$

This concludes our discussion of string-based phonology. We have tried to show how a phonological model based on FSAs is compatible with the list notation and type regime of HPSG. Next we move onto a consideration of morphology and the lexicon.

⁷ These techniques employ the following equivalences:

$$\begin{aligned} \neg \begin{bmatrix} A : \phi \\ B : \psi \end{bmatrix} &\equiv \neg[A : \phi] \vee \neg[B : \psi] \\ \neg[A : \phi] &\equiv [\neg(A : \top)] \vee [A : \neg\phi] \end{aligned}$$

Here $\neg(A:\top)$ indicates that the attribute A is not appropriate for this feature structure.

⁸ Sproat and Brunson (1987) have also proposed a model in which prosodic constituents are defined as conjunctions of constraints.

3. Morphology and the Lexicon

3.1 Linguistic Hierarchy

The subsumption ordering over types can be used to induce a hierarchy of grammatically well-formed feature structures. This possibility has been exploited in the HPSG analysis of the lexicon: lexical entries consist of the idiosyncratic information particular to the entry, together with an indication of the minimal lexical types from which it inherits. To take an example from Pollard and Sag (1987), the base form of the English verb *like* is given in Example 13.

Example 13

PHON : SYN LOC SUBCAT : SEM CONT :	$\langle l a t k \rangle$ $\langle []_2 []_1 \rangle$ RELN : <i>like</i> LIKER : 1 LIKEE : 2
--	--

main \wedge *base* \wedge *strict-trans*

Since *main* is a subtype of *verb*, the entry for *like* will inherit the constraint that its major class feature is *V*; by virtue of the type *strict-trans*, it will inherit the constraint that the first element in the SUBCAT list is an accusative *NP*, while the second element is a nominative *NP*; and so on for various other constraints. Figure 1 shows a small and simplified portion of the lexical hierarchy in which the verb *like* is a leaf node.

Along the phonological dimension of signs, lexical entries will have to observe any morpheme or word level constraints that apply to the language in question. When words combine as syntactic phrases, they will also have to satisfy all constraints on well-formed phonological phrases (which is not to say that phonological phrases are isomorphic with syntactic ones). In the general case, we may well want to treat words in the lexicon as unsyllabified sequences of segments. It would then follow that, for example, the requirement that syllable-initial voiceless obstruents be aspirated in English

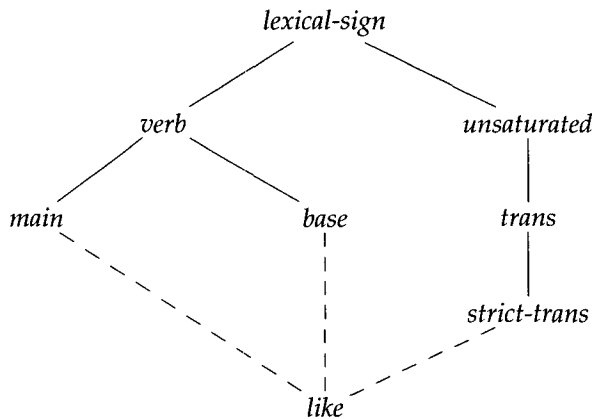

Figure 1
A portion of the lexical hierarchy.

would have to be observed by each syllable in a phrase (which in the limiting case, might be a single word), rather than lexical entries per se.

In some languages we may require there to be a special kind of interaction between the lexical and the prosodic hierarchy. For example, Archangeli and Pulleyblank (1989) discuss the tongue root harmony of Yoruba, which is restricted to nouns. If *atr* (i.e. advanced tongue root) was the type of harmonic utterances, then we could express the necessary constraint thus:

Example 14

$$\textit{noun} \left[\begin{array}{l} \text{PHON : } \quad \textit{phon} \wedge \textit{atr} \\ \text{SYN|LOC|HEAD : } \left[\begin{array}{l} \text{MAJ : } \textit{noun} \\ \text{LEX : } + \end{array} \right] \end{array} \right]$$

This kind of constraint is known as a morpheme structure constraint, and phonologists have frequently needed to have recourse to these (Kenstowicz and Kisseberth 1979). Another interaction between prosody and morphology is the phenomenon of prosodic morphology, an example of which can be found in Section 4.

3.2 Morphological Complexity

Given the syntactic framework of HPSG, it seems tempting to handle morphological complexity in an analogous manner to syntactic complexity. That is, morphological heads would be analyzed as functors that subcategorize for arguments of the appropriate type, and morphemes would combine in a Word-Grammar scheme. Simplifying drastically, such an approach would analyze the English third person singular present suffix *-s* in the manner shown in (15), assuming that affixes are taken to be heads.

Example 15

$$\textit{affix} \left[\begin{array}{l} \text{PHON : } \quad \langle \textit{s} \rangle \\ \text{SYNSEM|SUBCAT : } \langle \textit{verb-stem} \rangle \end{array} \right]$$

By adding appropriately modified versions of the Head Feature Principle, Subcategorization Principle, and linear order statements, such a functor would combine with a verb stem to yield a tree-structured sign for *walks*.

Example 16

$$\textit{verb} \left[\begin{array}{l} \text{PHON : } \left[\boxed{1} \text{ } \boxed{2} \right] \\ \text{DTRS : } \left\langle \textit{verb-stem} \left[\text{PHON : } \boxed{1} \langle \textit{w} \textit{ɔ} \textit{l} \textit{k} \rangle \right] \textit{affix} \left[\text{PHON : } \boxed{2} \langle \textit{s} \rangle \right] \right\rangle \end{array} \right]$$

While one may wish to treat derivational morphology in this way (cf. Krieger and Nerbonne [in press]), a more economical treatment of inflectional morphology is obtained if we analyze affixes as partially instantiated word forms.⁹ Example (17) illustrates this for the suffix *-s*, where *3ps* is a subtype of *sign*.

⁹ See Riehemann (1992) for a detailed working out of this idea for German derivational morphology.

Example 17

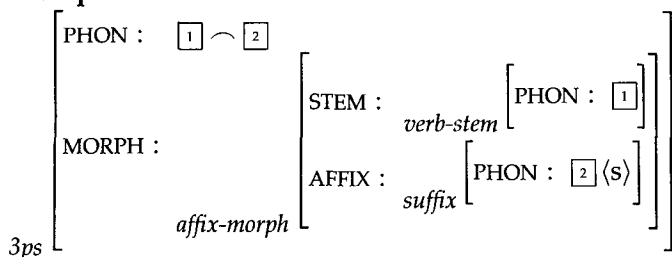

Note that we have added to *sign* a new attribute MORPH, with a value *morph*. The latter has two subtypes, *affix-morph* and *basic-morph*, depending on whether the value contains a stem and affix or just a stem.

Example 18

$\textit{morph} \Rightarrow \textit{affix-morph} \vee \textit{basic-morph}$

While both of these types will inherit the attribute STEM, *affix-morph* must also be defined for the attribute AFFIX:

Example 19

- a. $\textit{morph} \left[\text{STEM : } \textit{stem} \right]$
- b. $\textit{affix-morph} \left[\text{AFFIX : } \textit{affix} \right]$

Moreover, *affix* has two subtypes:

Example 20

$\textit{affix} \Rightarrow \textit{prefix} \vee \textit{suffix}$

Thus, (17) is a third person singular verb form whose stem is unspecified.

As indicated in Section 1.3, we can take the interpretation of a complex type to be equivalent to the disjunction of all of its subtypes. Now, suppose that our lexicon contained only two instances of *verb-stems*, namely *walk* and *meet*. Then (17) would evaluate to exactly two fully specified word forms, where *verb-stem* was expanded to the signs for *walk* and *meet* respectively. Example 21 illustrates the first of these options.

Example 21

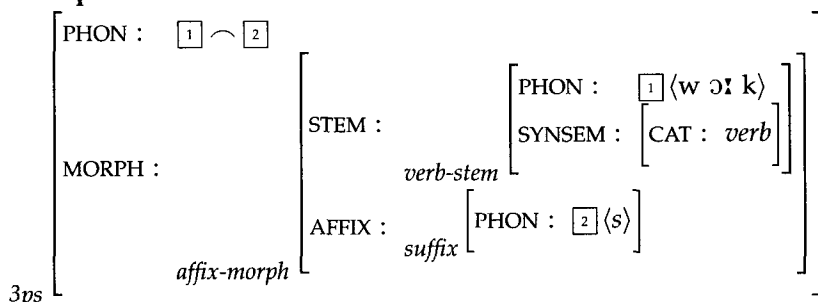

Of course, this statement of suffixation would have to be slightly enriched to allow for the familiar allomorphic alternation $-s \sim z \sim \text{ɪz}$. The first pair of allomorphs can be handled by treating the suffix as unspecified for voicing, together with a voicing assimilation rule similar to the homorganic nasal rule in (9). The third allomorph would admit an analysis similar to the one we propose for French schwa in Section 5.

A second comment on (21) is that the information about ordering of affixes relative to the stem should be abstracted into a more general pair of statements (one for prefixes and one for suffixes) that would apply to all morphologically complex lexical signs (e.g. of type *affixed*); this is straightforward to implement:

Example 22

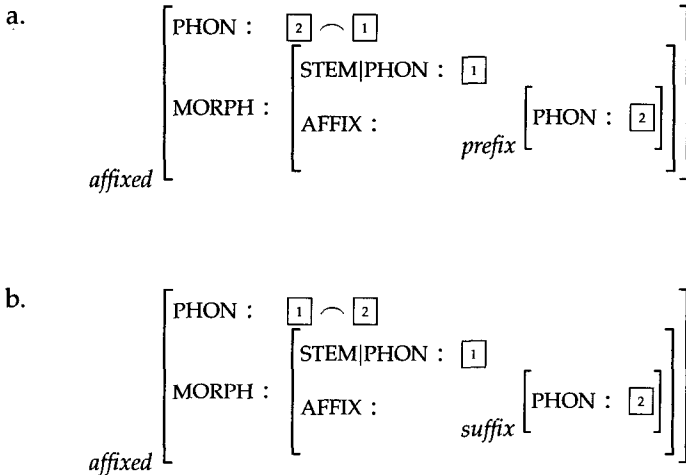

Given this constraint, it is now unnecessary to specify the phonology attribute for feature terms like (21).

Additionally, it is straightforward to prevent multiple copies of the plural suffix from being attached to a word by ensuring that *3ps* and *verb-stem* are disjoint.

3.3 Morphophonological Operations

In and of itself, HPSG imposes no restrictions on the kind of operations that can be performed in the course of composing morphemes into words, or words into phrases. As an illustration, consider the data from German verb inflections analyzed by Krieger, Pirker, and Nerbonne (1993). As they point out, the second person singular present inflection *-st* has three different allomorphs, phonologically conditioned by the stem:

Example 23

sag+st arbat+əst mɪks+t
 'say' 'work' 'mix'

Although the main thrust of their paper is to show how an FST treatment of this allomorphy can be incorporated into an HPSG-style morphological analysis, from a purely formal point of view, the FST is redundant. Since the lexical sign incorporates the phonologies of both stem and affix, segments can be freely inserted or deleted in constructing the output phonology. This is exemplified in (24) for *arbeitest* and *mixt* respectively.

Example 24

a.	<table style="border-collapse: collapse;"> <tr> <td style="padding-right: 10px;">PHON :</td> <td style="border: 1px solid black; padding: 2px;">1</td> <td style="padding: 0 5px;">∅</td> <td style="border: 1px solid black; padding: 2px;">2</td> </tr> <tr> <td style="padding-right: 10px;">MORPH :</td> <td colspan="3" style="border: 1px solid black; padding: 2px;"> STEM : 1 { ... { t, d } } SUFFIX : 2 { s t } </td> </tr> <tr> <td style="padding-right: 10px;">SYN LOC HEAD AGR :</td> <td colspan="3" style="border: 1px solid black; padding: 2px;"> NUM : sg PER : 2 </td> </tr> </table>	PHON :	1	∅	2	MORPH :	STEM : 1 { ... { t, d } } SUFFIX : 2 { s t }			SYN LOC HEAD AGR :	NUM : sg PER : 2		
PHON :	1	∅	2										
MORPH :	STEM : 1 { ... { t, d } } SUFFIX : 2 { s t }												
SYN LOC HEAD AGR :	NUM : sg PER : 2												
b.	<table style="border-collapse: collapse;"> <tr> <td style="padding-right: 10px;">PHON :</td> <td style="border: 1px solid black; padding: 2px;">1</td> <td style="padding: 0 5px;">∅</td> <td style="border: 1px solid black; padding: 2px;">2</td> </tr> <tr> <td style="padding-right: 10px;">MORPH :</td> <td colspan="3" style="border: 1px solid black; padding: 2px;"> STEM : 1 { ... { s, z, x } } SUFFIX : { s } ∅ 2 { t } </td> </tr> <tr> <td style="padding-right: 10px;">SYN LOC HEAD AGR :</td> <td colspan="3" style="border: 1px solid black; padding: 2px;"> NUM : sg PER : 2 </td> </tr> </table>	PHON :	1	∅	2	MORPH :	STEM : 1 { ... { s, z, x } } SUFFIX : { s } ∅ 2 { t }			SYN LOC HEAD AGR :	NUM : sg PER : 2		
PHON :	1	∅	2										
MORPH :	STEM : 1 { ... { s, z, x } } SUFFIX : { s } ∅ 2 { t }												
SYN LOC HEAD AGR :	NUM : sg PER : 2												

That is, we can easily stipulate that \emptyset is intercalated in the concatenation of stem and suffix if the stem ends with a dental stop (i.e either t or d); and that the s of the suffix is omitted if the stem ends with alveolar or velar fricative. Although an actual analysis along these lines would presumably be stated as a conditional, depending on the form of the stem, the point remains that all the information needed for manipulating the realization of the suffix (including the fact that there is a morpheme boundary) is already available without resorting to two level rules.¹⁰ Of course, the question this raises is whether such operations should be permitted, given that they appear to violate the spirit of a constraint-based approach. The position we shall adopt in this paper is that derivations like (24) should in fact be eschewed. That is, we shall adopt the following restriction:

Phonological Compositionality:

The phonology of a complex form can only be produced by either unifying or concatenating the phonologies of its parts.

We believe that some general notion of phonological compositionality is methodologically desirable, and we assume that Krieger, Pirker, and Nerbonne would adopt a similar position to ours. The specific formulation of the principle given above is intended to ensure that information-combining operations at the phonological level are monotonic, in the sense that all the information in the operands is preserved in the result. As we have just seen, the constraint-based approach does not guarantee this without such an additional restriction.

4. Sierra Miwok Templatic Morphology

Noncatenative morphology has featured centrally in the empirical motivations for autosegmental phonology, since McCarthy's demonstration that the intercalation of vowels in Arabic consonantal verb roots could be elegantly handled within this framework (McCarthy 1981). This section presents an approach to intercalation that uses key

¹⁰ This approach of using restructuring devices in the process of a derivation has been explored in the context of extended Montague frameworks by Wheeler (1981) and Hoeksema and Janda (1988).

insights from autosegmental phonology. However, they are captured within constraint-based grammar where the inflectional paradigm is realized as an inheritance hierarchy of partially instantiated stem forms (cf. Reinhard and Gibbon [1991]). We also show that autosegmental association of consonants and vowels to a skeleton can be modeled by reentrancy. Rather than classical Arabic, we use the simpler data from Sierra Miwok that Goldsmith (1990) chose to illustrate the phenomenon of intercalation in his textbook.

This section is divided into four subsections. In Section 4.1 we present an overview of the data, and in Section 4.2 we briefly show what a traditional generative analysis might look like. Our encoding of association by reentrancy is given in Section 4.3, while Section 4.4 contains our constraint-based analysis of Sierra Miwok stem forms.

4.1 Descriptive Overview

As mentioned above, Goldsmith (1990) takes data from Sierra Miwok verb stems to illustrate morphologically determined alternations in skeletal structure. He discusses three of the four types of stem, where the division into types depends primarily on the syllable structure of the basic form, which is the form used for the present tense. The three types are given the following autosegmental representations by Goldsmith:

Example 25

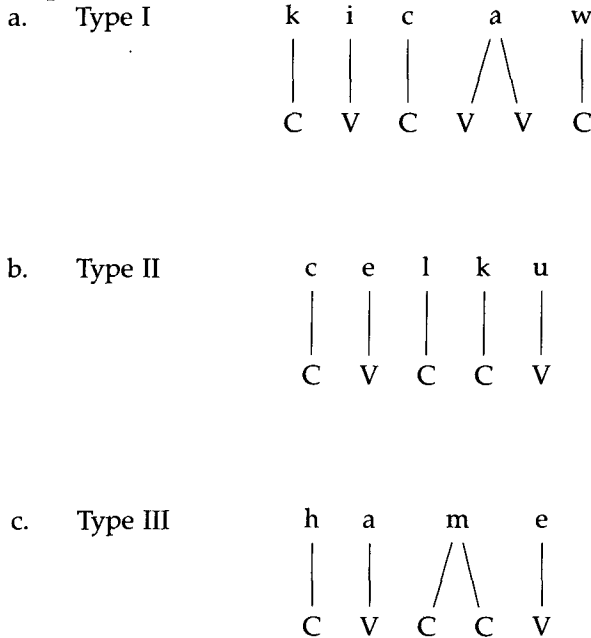

As shown in (26), each type has forms other than the basic one, depending on the morphological or grammatical context; these additional forms are called second, third, and fourth stems.

Although the associations of vowels and consonants exhibited above are taken as definitional for the three stem Types, from the data in (26) it appears that the distinction is only relevant to so-called Basic stem forms.

Example 26

Gloss	Basic stem	Second stem	Third stem	Fourth stem
Type I				
<i>bleed</i>	kicaaw	kicaww	kiccaaw	kicwa
<i>jump</i>	tuyaaŋ	tuyaŋŋ	tuyyaŋ	tuyŋa
<i>take</i>	patiit	patitt	pattit	patti
<i>roll</i>	huteel	hutell	huttel	hutle
Type II				
<i>quit</i>	celku	celukk	celluk	celku
<i>go home</i>	woʔlu	woʔull	woʔʔul	woʔlu
<i>catch up with</i>	nakpa	nakapp	nakkap	nakpa
<i>spear</i>	wimki	wimikk	wimmik	wimki
Type III				
<i>bury</i>	hamme	hameʔʔ	hammeʔ	hamʔe
<i>dive</i>	ʔuppi	ʔupiʔʔ	ʔuppiʔ	ʔupʔi
<i>speak</i>	liwwa	liwaʔʔ	liwwaʔ	liwʔa
<i>sing</i>	milli	miliʔʔ	milliʔ	miʔli

4.2 Segmental Analysis

Goldsmith (1990) has shown just how complex a traditional segmental account of Sierra Miwok would have to be, given the assumption that all of the stem forms are derived by rule from a single underlying string of segments (e.g. that *kicaww*, *kiccaaw* and *kicwa* are all derived from *kicaaw*). Here, we simplify Goldsmith’s analysis so that it just works for Type I stems. The left-hand column of (27) contains four rules, and these are restricted to the different forms according to the second column.

Example 27

Rules	Form	Second	Third	Fourth
		k i c a a w	k i c a a w	k i c a a w
$V_i \rightarrow \emptyset / C - V_i C]$	all	k i c a w	k i c a w	k i c a w
$C_i \rightarrow C_i C_i / -]$	2	k i c a w w	—	—
$C_i \rightarrow C_i C_i / [CV - V$	3	—	k i c c a w	—
$VC] \rightarrow CV$	4	—	—	k i c w a
		k i c a w w	k i c c a w	k i c w a

Thus, the first rule requires that a vowel V_i is deleted if it occurs after a consonant and immediately before an identical vowel V_i that in turn is followed by a stem-final consonant. Goldsmith soundly rejects this style of analysis in favor of an autosegmental one:

This analysis, with all its morphologically governed phonological rules, arbitrary rule ordering, and, frankly, its mind-boggling inelegance, ironically misses the most basic point of the formation of the past tense in Sierra Miwok. As we have informally noted, all the second

stem forms are of the shape CVCVCC, with the last consonant a geminate, and the rules that we have hypothetically posited so far all endeavor to achieve that end without ever directly acknowledging it. (Goldsmith 1990:87)

4.3 Association

We shall not attempt here to give a general encoding of association, although the technique used in Sections 5.4 could be applied to achieve this end. Moreover, like Goldsmith we shall ignore the role of syllable structure in the data, though it clearly does play a role. Instead, we shall confine our attention to the manner in which skeletal slots are linked to the consonant and vowel melodies. Consider again the skeletal structure of Type I verb stems shown in (25a). As Goldsmith (1990) points out, there is a closely related representation that differs only in that the CV information is split across two tiers (and which allows a much more elegant account of metathesis and gemination):

Example 28

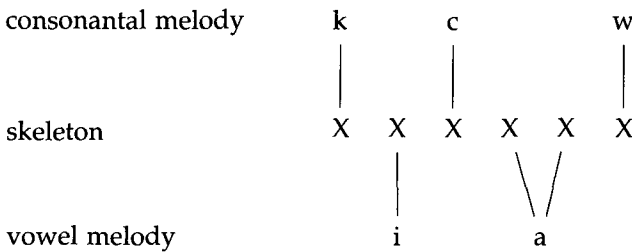

The diagram in Example 28 can be translated into the following feature term:

Example 29

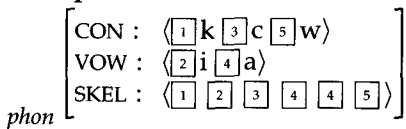

That is, since association in (28) consists of slot-filling (rather than the more general temporal interpretation), it can be adequately encoded by coindexing.

4.4 Basic Stem Forms

The analysis starts from the assumption that the Sierra Miwok lexicon will contain minimally redundant entries for the three types of verb root. Let us consider the root corresponding to the basic stem form *kicaaw*. We take the unpredictable information to be the consonantal and vowel melodies, the valency, the semantics, and the fact it is a Type I verb stem. This is stated as (30), together with the declaration that *lex-bleed* is a subtype of *v-root-I*.

Example 30

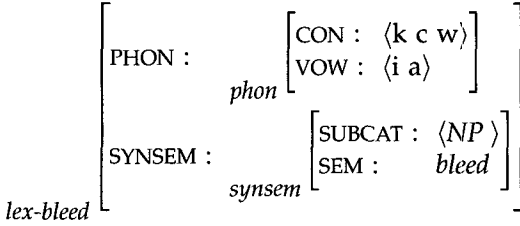

Notice that we have said nothing about how the melodies are anchored to a skeleton—this will be a task for the morphology. Additionally, this entry will inherit various properties by virtue of its type *v-root-I*. The three types of verb root share at least one important property, namely that they are all verbs. This is expressed in the next two declarations:

Example 31

- a. $v-root \Rightarrow v-root-I \vee v-root-II \vee v-root-III$
- b. $v-root \left[\begin{array}{l} SYNSEM|CAT : verb \end{array} \right]$

We shall also assume, for generality, that every *v-root* is a *root*, and that every *root* is a *morph*. Anticipating the rest of this section, we show how all the postulated types are related in Figure 2. The next step is to show how a *v-root-I* like (30) undergoes morphological modification to become a basic verb stem; that is, a form *with* skeletal structure. Our encoding of the morphology will follow the lines briefly sketched in Section 3.2.

We begin by stating types that encode the patterns of skeletal anchoring associated with the three types of basic stem.

Example 32

$$phon \Rightarrow template-I \vee template-II \vee template-III$$

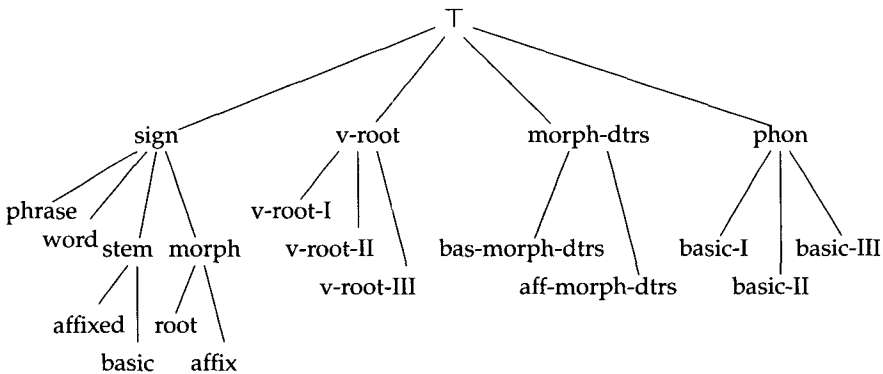

Figure 2
Sierra Miwok type hierarchy.

The appropriateness constraints on these types are given in (33). As an aid to readability, the numerical tags are supplemented with a C or a V to indicate the type of value involved.

Example 33

$$\text{a. } \left[\begin{array}{l} \text{CON : } \langle \boxed{1} \text{C } \boxed{3} \text{C } \boxed{5} \text{C} \rangle \\ \text{VOW : } \langle \boxed{2} \text{V } \boxed{4} \text{V} \rangle \\ \text{SKEL : } \langle \boxed{1} \text{C } \boxed{2} \text{V } \boxed{3} \text{C } \boxed{4} \text{V } \boxed{4} \text{V } \boxed{5} \text{C} \rangle \end{array} \right] \\
 \text{template-I}$$

$$\text{b. } \left[\begin{array}{l} \text{CON : } \langle \boxed{1} \text{C } \boxed{3} \text{C } \boxed{5} \text{C} \rangle \\ \text{VOW : } \langle \boxed{2} \text{V } \boxed{4} \text{V} \rangle \\ \text{SKEL : } \langle \boxed{1} \text{C } \boxed{2} \text{V } \boxed{3} \text{C } \boxed{4} \text{V } \boxed{5} \text{C} \rangle \end{array} \right] \\
 \text{template-II}$$

$$\text{c. } \left[\begin{array}{l} \text{CON : } \langle \boxed{1} \text{C } \boxed{3} \text{C} \rangle \\ \text{VOW : } \langle \boxed{2} \text{V } \boxed{4} \text{V} \rangle \\ \text{SKEL : } \langle \boxed{1} \text{C } \boxed{2} \text{V } \boxed{3} \text{C } \boxed{3} \text{C } \boxed{4} \text{V} \rangle \end{array} \right] \\
 \text{template-III}$$

Each of these types specializes the constraints on the type *phon*, and each can be unified with the *phon* value earlier assigned to the root form of *kicaaw* in (30). In particular, the conjunction of constraints given in (34) evaluates to (29), repeated here:

Example 34

$$\text{phon} \left[\begin{array}{l} \text{CON : } \langle \text{k c w} \rangle \\ \text{VOW : } \langle \text{i a} \rangle \end{array} \right] \wedge \text{template-I}$$

Example 29

$$\text{phon} \left[\begin{array}{l} \text{CON : } \langle \boxed{1} \text{k } \boxed{3} \text{c } \boxed{5} \text{w} \rangle \\ \text{VOW : } \langle \boxed{2} \text{i } \boxed{4} \text{a} \rangle \\ \text{SKEL : } \langle \boxed{1} \boxed{2} \boxed{3} \boxed{4} \boxed{4} \boxed{5} \rangle \end{array} \right]$$

However, we also need to specify the dependency between the three types of verb root, and the corresponding phonological exponents that determine the appropriate basic stem forms (cf. Anderson [1992]). As a first attempt to express this, let us say that *stem* can be either *basic* or *affixed*:

Example 35

$$\text{stem} \Rightarrow \text{affixed} \vee \text{basic}$$

Type declaration (35) ensures that *basic* will inherit from *stem* the following constraint, namely that its SYNSEM value is to be unified with its MORPH's ROOT's SYNSEM value:

Example 36

$$\text{stem} \left[\begin{array}{l} \text{SYNSEM : } \boxed{1} \\ \text{MORPH|ROOT|SYNSEM : } \boxed{1} \end{array} \right]$$

We could now disjunctively specify the following three sets of constraints on *basic*:

Example 37

- a.
$$\text{basic} \left[\begin{array}{l} \text{PHON : } \textit{phon} \wedge \textit{template-I} \\ \text{MORPH : } \left[\text{ROOT : } \textit{v-root-I} \right] \end{array} \right]$$
- b.
$$\text{basic} \left[\begin{array}{l} \text{PHON : } \textit{phon} \wedge \textit{template-II} \\ \text{MORPH : } \left[\text{ROOT : } \textit{v-root-II} \right] \end{array} \right]$$
- c.
$$\text{basic} \left[\begin{array}{l} \text{PHON : } \textit{phon} \wedge \textit{template-III} \\ \text{MORPH : } \left[\text{ROOT : } \textit{v-root-III} \right] \end{array} \right]$$

Although the example in question does not dramatize the fact, this manner of encoding morphological dependency is potentially very redundant, since *all* the common constraints on *basic* have to be repeated each time.¹¹ In this particular case, however, it is easy to locate the dependency in the *phon* value of the three subtypes of *v-root*, as follows:

Example 38

- $$\textit{v-root-I} \left[\text{PHON : } \textit{template-I} \right]$$
- $$\textit{v-root-II} \left[\text{PHON : } \textit{template-II} \right]$$
- $$\textit{v-root-III} \left[\text{PHON : } \textit{template-III} \right]$$

We then impose the following constraint on *basic*:

Example 39

- $$\text{basic} \left[\begin{array}{l} \text{PHON : } \boxed{1} \\ \text{MORPH|ROOT : } \textit{v-root} \left[\text{PHON : } \boxed{1} \right] \end{array} \right]$$

By iterating through each of the subtypes of *v-root*, we can infer the appropriate value of PHON within MORPH's ROOT, and hence infer the value of PHON at the top level of the feature term. Example 40 illustrates the result of specializing the type *v-root* to *lex-bleed*:

¹¹ In an attempt to find a general solution to this problem in the context of German verb morphology, Krieger and Nerbonne (in press) adopt the device of 'distributed disjunction' to iteratively associate morphosyntactic features in one list with their corresponding phonological exponents in another list.

Example 40

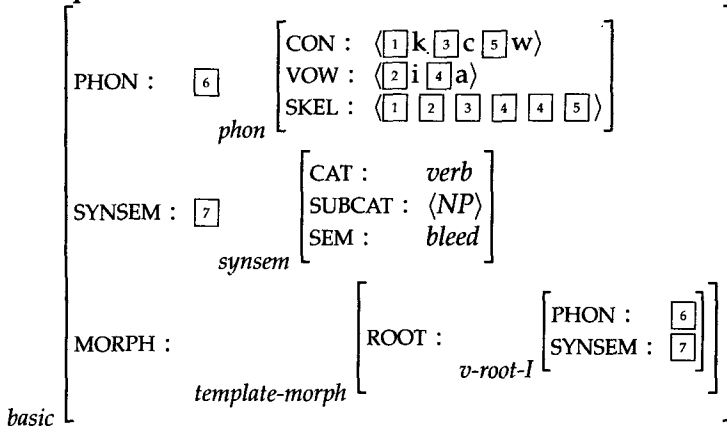

Exactly the same mechanisms will produce the basic stem for the other two types of verb root. For an account of the other alternations presented in Goldsmith’s paradigm, and for some discussion of how lexical and surface forms determine each other, see Klein (1993).

We have just seen an application of constraint-based phonology to Sierra Miwok. In order to illustrate some of the other expressive capabilities of the approach, we now turn to the phenomenon of French schwa.

5. French Schwa

Many phonological alternations can be shown to depend on properties of prosodic structure. In this section we show how the French phenomenon of schwa-zero alternation arises out of the interplay of various syllable structure requirements. This is done by introducing a system of prosodic types for syllables and a special type declaration showing how a string of segments can be ‘parsed’ into syllables. The standard (but nonmonotonic) ONSET MAXIMIZATION PRINCIPLE is reinterpreted in the system, as well as the exceptions to this principle due to a class of words known as h-aspiré words. We also show how a certain kind of disjunction can be used to deal with free variation. As we shall see, some linguistic analyses are more amenable to a declarative encoding than others. In order to demonstrate this, it will be necessary to go into some detail concerning the linguistic data.

This section is divided into four subsections. In Section 5.1 we present a descriptive overview of the data,¹² and in Section 5.2 we sketch a traditional generative analysis. A more recent, nonlinear analysis appears in Section 5.3 while our own, constraint-based version is presented in Section 5.4.

5.1 Descriptive Overview

Unlike schwa in English, the French schwa (or mute *e*) is a full vowel, usually realized as the low-mid front rounded vowel *œ* (and sometimes as the high-mid front rounded vowel *ø* in certain predictable environments). Its distinctive characteristic is that under

¹² The data is from standard French taken from (cited) literature, although in some instances we have found speakers with different acceptability judgments than reported here. See Morin (1987) for a discussion of some problems with the treatment of French data in the literature.

certain conditions, it fails to be realized phonetically.¹³ From now on we shall use the term 'schwa' to refer to the vowel with this characteristic, rather than to the segment ə.

Although schwa is associated with orthographic *e*, not all *es* will concern us here. For example, the orthographic *e* of *samedi* [sam.di] 'Saturday' can be taken to indicate that the previous vowel should not be nasalized, while the final *e* of *petite* [pœ.tit] indicates that the final *t* should be pronounced. In morphology, orthographic *e* marks feminine gender, first-conjugation verbs, and subjunctive mood.

Instead, we shall be concerned with the pattern of realization and non-realization exhibited by schwa—a pattern that we interpret as grounded in the alternation of two allophones of schwa: œ and ∅ (zero). This alternation is manifested in forms like (41),¹⁴ where the dots indicate syllable boundaries.

Example 41

- a. six melons [si.mœ.l̩] ~ [sim.l̩]
 b. sept melons [sɛt.mœ.l̩], *[sɛtm̩l̩]

Observe that while *six melons* can be pronounced with or without the schwa, *sept melons* requires the schwa in order to break up the *tml* cluster that would otherwise be formed. Unfortunately, the conditions on the distribution of schwa are not as simple (and purely phonological) as this example implies. As we shall see, schwa alternation in French is governed by an interesting mixture of lexical and prosodic constraints.

In the remainder of this section, we dispel the initial hypothesis that arises from (41), namely that schwa alternation is to be treated as a general epenthesis process.¹⁵ Consider the following data (Morin 1978:111).

Example 42

Cluster	Schwa Possible/Obligatory	Schwa Impossible
rdr	bordereau [bɔr.dœ.ro]	perdrix [pɛr.dri]
rʃ	derechef [dœ.rœ.ʃɛf]	torchon [tɔr.ʃɔ̃]
skl	squelette [skœ.lɛt]	sclérose [sklɛ.roz]
ps	dépecer [de.pœ.se]	éclipser [ek.li.p.se]

The table in (42) gives data for the clusters [rdr], [rʃ], [skl] and [ps]. In the first column of data, the œ is possible or obligatory, while in the second column, it is absent. Thus, we see that the appearance of œ cannot be predicted on phonotactic grounds alone. Consequently, we shall assume that schwa must be encoded in lexical representations. Note that it is certainly not the case that a lexical schwa will be posited wherever there is an orthographic *e*. Consider the data in (43), where these orthographic *es* are underlined.

13 The data used in this section is drawn primarily from the careful descriptive work of Morin (1978) and Tranel (1987b). The particular approach to French schwa described in the following paragraphs most closely resembles the analysis of Tranel (1987a).

14 We shall not be concerned with another œ~∅ alternation known as elision. This is a phonologically conditioned allomorphy involving alternations such as *le~l'*, for example, *le chat* [lœ.ʃa], *l'ami* [la.mi].

15 This epenthesis hypothesis was advanced by Martinet (1972).

Example 43

Orthography	With Schwa	Without Schwa
bord <u>e</u> reau	[bɔr.dœ.ro]	—
fais- <u>l</u> e	[fɛ.lø]	—
six m <u>e</u> lons	[si.mœ.lɔ̃]	[sim.lɔ̃]
pell <u>e</u> terie	—	[pɛl.tri]

In a purely synchronic analysis there is no basis for discussing an alternating vowel for *bordereau*, *fais-le* and *pelletterie*. Many orthographic *es* that are not in the first syllable of a word come into this category.

Accordingly, we begin our analysis with three background assumptions: the alternating schwa is (i) prosodically conditioned, (ii) lexically conditioned, and (iii) not in direct correspondence with orthographic *e*. Next we present a generative analysis of schwa due to Dell, followed by an autosegmental analysis due to Tranel. We conclude with our own, syllable-based analysis.

5.2 A Traditional Generative Analysis

The traditional approach to vowel-zero alternations is to employ either a rule of epenthesis or a deletion rule. Dell discusses the case of the word *secoue*, whose pronunciation is either [sku] or [sœku], in a way that parallels (41).

In order to account for alternations such as that between [sku] and [sœku] there are two possibilities: the first consists of positing the underlying representation /sku/ where no vowel appears between /s/ and /k/, and to assume that there exists a phonological rule of epenthesis that inserts a vowel œ between two consonants at the beginning of a word when the preceding word ends in a consonant. . . . The second possibility is preferable: the vowel [œ] that appears in *Jacques secoue* is the realisation of an underlying vowel /ə/ which can be deleted in certain cases. We shall posit the VCE₁ rule, which deletes any /ə/ preceded by a single word-initial consonant when the preceding word ends in a vowel.

$$\text{VCE}_1: \quad \text{ə} \rightarrow \emptyset / \text{V} \#_1 \text{C} \text{ —}$$

(Dell, 1980:161f)

Suppose we were to begin our analysis by asking the question: how are we to express the generalization about schwa expressed in the above rule? Since our declarative, monostratal framework does not admit deletion rules, we would have to give up. As we shall see below, however, we begin with a different question: how are we to express the *observation* about the distribution of schwa that Dell encodes in the above rule?

There is another good reason for taking this line. As it happens, there is an empirical problem with the above rule, which Dell addresses by admitting a potentially large number of lexical exceptions to the rule and by making ad hoc stipulations (Dell 1980). Additionally, adding diacritics to lexical entries to indicate which rules they undergo and employing rules that count # boundaries would seem to complicate a grammar formalism unnecessarily. As we saw above for the discussion of the word *bordereau*, in the approach taken here we have the choice between positing a stable

œ or one that alternates with zero (i.e. a schwa) in the lexicon, whereas Dell must mark lexical items to indicate which rules they must not undergo. There is also some evidence for a distinction between the phonetic identity of the œ allophone of schwa and the phonetic identity of a nonalternating lexical œ in some varieties of French, requiring that the two be distinguished phonologically (Morin 1978).

Thus, the fact that Dell's analysis involves deletion does not provide a significant stumbling block to our approach. However, Dell employs another procedural device, namely rule ordering, in the application of the rule. In discussing the phrase *vous me le dites* [vu.m(œ).l(œ).dit], in which either schwa (but not both) may be omitted, Dell writes:

VCE₁ begins on the left and first deletes the schwa of *me*, producing /vu#m#lœ#dit/. But VCE₁ cannot operate again and delete the schwa of *le*, for, although this schwa was subject to the rule in the original representation, it no longer is once the schwa of *me* has been dropped. In other words, the first application of VCE₁ creates new conditions that prevent it from operating again in the following syllable (Dell 1980:228).

Again, we are not interested in encoding Dell's particular generalization, and in fact we are unable to. Rather, it is necessary to look at the underlying observation about the distribution of schwa. The observation is that schwa does not appear as its zero allophone in consecutive syllables. This observation is problematic for us, in that it refers to two levels of representation, an underlying (or lexical) level involving a schwa segment, and a surface level involving a zero allophone. We cannot formulate this observation monostratally. However, we can come up with a different observation, namely that the vowel is never omitted if the omission results in unacceptable syllable structure. In the case of Dell's example, *vous me le dites*, if both schwas are omitted the result is a [vml] cluster, which cannot be broken up into a valid coda-onset sequence. This new observation makes a different empirical prediction, namely that schwa can be omitted in consecutive syllables just in case the result is syllabifiable. As we shall see below in (51), this prediction is actually borne out.

Before proceeding with our own analysis, we present an overview of an autosegmental analysis of French schwa due to Tranel. This analysis is interesting because it demonstrates the oft-repeated phenomenon of enriched representations leading to dramatically simplified rule systems. Given the heavy restriction on rules in a monostratal framework, it will be more natural to take Tranel's (rather than Dell's) analysis as our starting point.

5.3 Tranel's Analysis

Tranel (1987a) provides an insightful analysis of French schwa cast in the framework of autosegmental phonology. In this section we give an overview of this analysis. In the following section we shall endeavour to provide an empirically equivalent analysis.

Tranel adopts a CV skeleton tier and a segmental tier. Schwa is represented as an unlinked vowel, as shown in the following representation for *melons*.

Example 44

C	C	V
m	œ	l ̃

On top of this two-tiered structure, Tranel proposes a level of hierarchical organization for representing syllable structure. Tranel adopts the two syllable formation rules given in (45). A third (unstated) rule is assumed to incorporate unsyllabified consonants into coda position.

Example 45

a. Basic syllable formation

b. Schwa-syllable formation

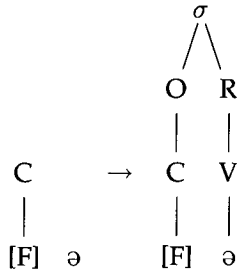
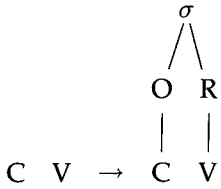

Note that (45a) does not apply to the *mæ* sequence in (44), as the schwa is not linked to a *V* node as required on the left-hand side of rule (45a). (Tranel later adopts a refinement to (45a), preventing it from applying if the *V* is the first vowel of an *h*-aspiré morpheme.) For the phrases *six melons* and *sept melons*, the basic syllable formation rule builds the following structures.

Example 46

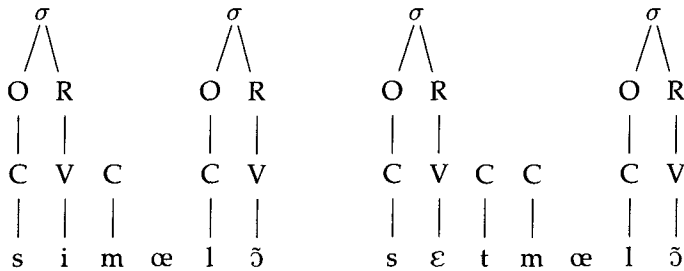

The remaining consonants must either be syllabified leftward into an unsaturated coda or remain unsyllabified and rescued by the schwa syllable formation rule. For *six melons*, both options are possible, as illustrated below. Note that the unlinked *œ* is assumed to be phonetically uninterpreted.

Example 47

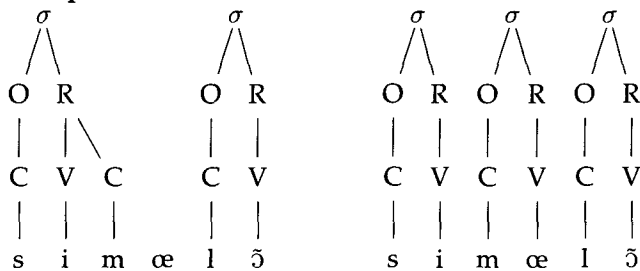

This gives us the two options, [sim.lð] and [si.mœ.lð], according with the observation

in (41). For *sept melons*, however, there is just the one option. The *t* must be syllabified into the preceding coda, and the *m* requires the presence of schwa, and so we have [sɛt.mœ.lɔ̃]. Further examples of this particular kind of schwa alternation are given below (Tranel 1987b:91).

Example 48

Schwa Required		Schwa Optional	
de qui parlez-vous?	[dœkiparlevu]	vous parlez de qui?	[vuparled(œ)ki]
te casse pas la tête	[tœkɑspalatɛt]	ne te casse pas la tête	[nœt(œ)kɑspalatɛt]
debout	[dœbu]	il est debout	[ilɛd(œ)bu]
depuis quatre ans	[dœpɥikatrɑ̃]	c'est depuis quatre ans	[sɛd(œ)pɥikatrɑ̃]
dedans	[dœdɑ̃]	là-dedans	[lad(œ)dɑ̃]
je joue	[ʒœʒu]	mais je joue	[mɛʒ(œ)ʒu]
le lait	[lœlɛ]	dans le lait	[dɑ̃l(œ)lɛ]
ce salon	[sœsalɔ̃]	dans ce salon	[dɑ̃s(œ)salɔ̃]

So far, we have seen the case where the leftward syllabification of a consonant licenses the omission of schwa. Now we turn to a similar case, but where the consonant syllabifies rightward into a following onset provided that the resulting onset cluster is permitted. The data in (49) are from Tranel (1987b:92).

Example 49

secoue pas la tête	[sku.pa.la.tɛt]~[sœ.ku.pa.la.tɛt]	'don't shake your head'
je pense pas	[ʃpɑ̃s.pa]~[ʒœ.pɑ̃s.pa]	'I don't think so'
ce bon à rien	[zbɔ̃.a.rjɛ̃]~[sœ.bɔ̃.a.rjɛ̃]	'this good-for-nothing'

Tranel gives two additional syllable formation rules, shown in (50).

Example 50

a. Onset accretion

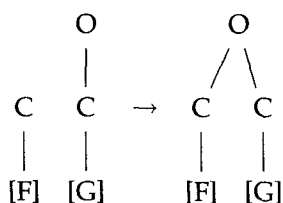

Restriction:

must create a valid onset

b. Onset accretion across schwa

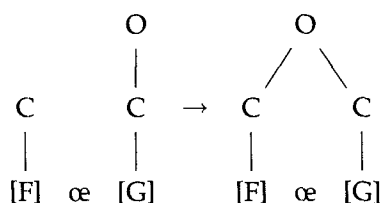

Restriction:

[F] must be word-initial

Rule (50a) incorporates as many consonants as possible into an onset so long as the onset conforms to the phonotactic constraints of the language. Rule (50b), of most interest here, allows for a consonant to be incorporated into a following onset even if there is an intervening schwa, provided that the consonant is word-initial (and that the resulting onset is allowable). The intervening schwa remains unpronounced. Rule (50b), which is optional, correctly captures the alternations displayed in (49). This rule is restricted to apply word-initially "so as to avoid the generation of word-internal trilateral consonant clusters from underlying /CCəC/ sequences (compare *marguerite*

/margərit/ [margərit] *[margrit] and *margrave* /margrav/ [margrav] *[margərav])” (Tranel 1987a:852). Thus, although many CCC sequences are acceptable phonologically, they are not permitted if a schwa is available to break up the cluster.

We also note that Tranel’s analysis (Tranel 1987a) gives the correct result for cases of deletion of schwa in consecutive syllables. Consider the following data.

Example 51

- a. *on ne se moque pas* [ɔ̃n.smək.pa] (Valdman 1976:120)
 b. *sur le chemin* [syl.ʃmɛ̃] (Morin 1978:82)

For both of these cases we observe an “underlying” $C_1\text{œ}C_2\text{œ}$ pattern, but where both œs are omitted and where C_1 syllabifies into the preceding coda and C_2 syllabifies into the following onset.

To conclude, we can summarize the empirical content of Tranel’s analysis as follows:

- (a) Every consonant must be syllabified.
- (b) Schwa must be realized if it provides the syllable nucleus for an immediately preceding consonant that:
 - (i) cannot be syllabified into a coda, and
 - (ii) cannot form a permissible (word) onset with an immediately following consonant.

Naturally, this statement is not the last word on French schwa and there may be ways in which it needs to be revised, such as for the treatment of word-final schwas and thematic schwas (Tranel 1987a:855ff). However, since our purpose is primarily to illustrate the workings of the theoretical model, we shall take the above statement as a well-defined starting point on which to base the following analysis.

5.4 A Constraint-Based Analysis

Given our formal semantics for the autosegmental notation, it would be a relatively straightforward matter to implement Tranel’s analysis directly, especially since the rules only involve the building of structure, and there is no use of destructive processes. Tranel’s analysis is fully declarative.

However, as it happens, there is no need for us to adopt the rich representation Tranel employs. We can simulate his analysis using a single tier (rather than two) while retaining a representation of syllable structure. Observe that the use of the CV tier and the melody tier was motivated solely by the need to have a floating autosegment, the œ. It is equivalent to collapse these two tiers, using the alternation $\text{œ} \sim \emptyset$ in place of the floating œ. This style of approach to zero alternations, which dates back to Bloomfield (1926), will employ the parenthesis notation for optional items that was defined in Section 2.1. We follow Tranel in representing syllable structure and we shall do this using the notation shown in (52).¹⁶

¹⁶ Our analysis is not crucially tied to this particular version of syllable structure, which is most closely related to the proposals of Kahn (1976) and Clements and Keyser (1983).

Example 52

$$syl \left[\begin{array}{l} \text{ONS : } onset \\ \text{NUC : } nucleus \\ \text{CODA : } coda \end{array} \right]$$

An independent tier that represents syllable structure will be encoded as a sequence of such syllables, where the segmental constituents of the syllable structure are coindexed with a separate segmental tier, as defined in (53). Note that the indices in (53) range over lists that may be empty in the case of onsets and codas, and that the type *phrase* denotes phonological phrases.

Example 53

a.

$$phrase \left[\begin{array}{l} \text{SYLS : } \left\langle \begin{array}{l} syl \left[\begin{array}{l} \text{ONS : } \boxed{1} \\ \text{NUC : } \boxed{2} \\ \text{CODA : } \boxed{3} \end{array} \right] \sim \boxed{4} \end{array} \right\rangle \\ \text{SEGS : } \boxed{1} \sim \boxed{2} \sim \boxed{3} \sim \boxed{5} \end{array} \right] \Rightarrow phrase \left[\begin{array}{l} \text{SYLS : } \boxed{4} \\ \text{SEGS : } \boxed{5} \end{array} \right]$$

b.

$$phrase \left[\begin{array}{l} \text{SYLS : } \langle \rangle \\ \text{SEGS : } \langle \rangle \end{array} \right]$$

The notation of (53) states that in order for something to be a well-formed phrase, its sequence of segments must be parsed into a sequence of well-formed syllables. In more familiar terms, one could paraphrase (53) as stating that the domain of syllabification in French is the phrase.

As a simple illustration of the approach, consider again the word *melons*. The proposed lexical representation for the phonology attribute of this word is [SEGS : ⟨m (æ) l ɔ̃⟩]. When we insist that any phrase containing this word must consist of a sequence of well-formed syllables, we can observe the following pattern of behavior for *six melons*.

Example 54

a.

$$phrase \left[\begin{array}{l} \text{SYLS : } \left\langle \begin{array}{l} syl \left[\begin{array}{l} \text{ONS : } \langle s \rangle \\ \text{NUC : } \langle i \rangle \\ \text{CODA : } \langle \rangle \end{array} \right]_{syl} \left[\begin{array}{l} \text{ONS : } \langle m \rangle \\ \text{NUC : } \langle \text{æ} \rangle \\ \text{CODA : } \langle \rangle \end{array} \right]_{syl} \left[\begin{array}{l} \text{ONS : } \langle l \rangle \\ \text{NUC : } \langle \text{ɔ̃} \rangle \\ \text{CODA : } \langle \rangle \end{array} \right]_{syl} \end{array} \right\rangle \\ \text{SEGS : } \langle s \ i \ m \ \text{æ} \ l \ \text{ɔ̃} \rangle \end{array} \right]$$

b.

$$phrase \left[\begin{array}{l} \text{SYLS : } \left\langle \begin{array}{l} syl \left[\begin{array}{l} \text{ONS : } \langle s \rangle \\ \text{NUC : } \langle i \rangle \\ \text{CODA : } \langle m \rangle \end{array} \right]_{syl} \left[\begin{array}{l} \text{ONS : } \langle l \rangle \\ \text{NUC : } \langle \text{ɔ̃} \rangle \\ \text{CODA : } \langle \rangle \end{array} \right]_{syl} \end{array} \right\rangle \\ \text{SEGS : } \langle s \ i \ m \ l \ \text{ɔ̃} \rangle \end{array} \right]$$

Observe in the above example that the syllabic position of *m* is variable. In Example 54a *m* is in an onset while in 54b it is in a coda. Therefore, it is inappropriate to

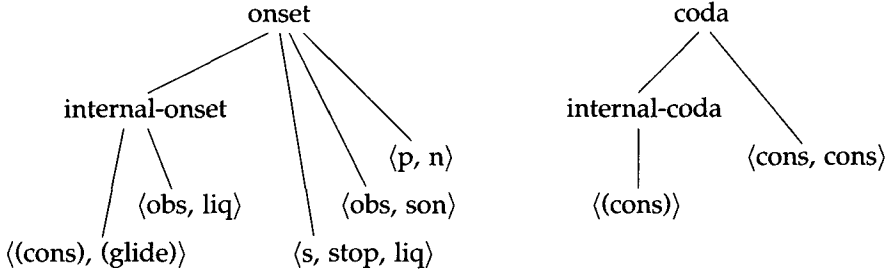

Figure 3
Parts of French type hierarchy.

insist that the syllabic affiliation of segments is determined lexically. Rather, we have opted for the prosodic type *phrase*, insisting that anything of this type consists of one or more well-formed syllables (cf. Example 11).

Now consider the case of the phrase *sept melons*. This is similar to the situation in (54), except that we must find a way of ruling out the *tml* cluster as a valid coda-onset sequence. We are not aware of any exhaustive study of possible French consonant clusters, although one can find discussions of particular clusters (e.g., Tranel [1987b:95ff] shows that CLj onset clusters are not tolerated). Consequently, the two hierarchies in Figure 3 are necessarily preliminary, and are made more for the sake of being explicit than for their precise content. Note that parentheses indicate optionality, so, for example, both onsets and codas are allowed to be null. Additional stipulations will be necessary to ensure that an intervocalic consonant is syllabified with the material to its right. We can do this by preventing an onsetless syllable from following a closed syllable, with the type *onset-max-1*.

Example 55

$$onset-max-1 \equiv \neg \left\langle \dots \underset{phrase}{syl} \left[\begin{matrix} CODA : \\ nelist \end{matrix} \right] \underset{phrase}{syl} \left[\begin{matrix} ONS : \\ elist \end{matrix} \right] \dots \right\rangle$$

Now consider again the phrase *six melons*. The syllabification *[si.mœl.ʃ] would be represented as follows:

Example 56

$$* \left\langle \underset{syl}{\left[\begin{matrix} ONS : <s> \\ NUC : <i> \end{matrix} \right]} \underset{syl}{\left[\begin{matrix} ONS : <m> \\ NUC : <œ> \\ CODA : nelist \langle l \rangle \end{matrix} \right]} \underset{syl}{\left[\begin{matrix} ONS : elist \\ NUC : <ʃ> \end{matrix} \right]} \right\rangle$$

Observe that this list of syllables contains a violation of (55), so [si.mœl.ʃ] is ruled out. Now that we have considered vowel-consonant-vowel (VCV) sequences, we shall move on to more complex intervocalic consonant clusters.

Although the constraints in Figure 3 produce the desired result for VLLV clusters (L=liquid), by assigning each liquid to a separate syllable (Tranel 1987b), there is still ambiguity with VOLV clusters (O=obstruent), which are syllabified as V.OLV according to Tranel. We can deal with this and similar ambiguities by further refining

the classification of syllables and imposing suitable constraints on syllable sequences. Here is one way of doing this, following the same pattern that we saw in (55).

Example 57

$$\text{onset-max-2} \equiv \neg \left\langle \dots \underset{\text{phrase}}{\text{syl}} \left[\text{CODA} : \langle \dots \text{obs} \dots \rangle \right] \underset{\text{syl}}{\left[\text{ONS} : \neg \langle \dots \text{obs} \dots \rangle \right]} \dots \right\rangle$$

This constraint states that it is not permissible to have an obstruent in a syllable coda if the following onset lacks an obstruent. Equivalently, we could say that if a syllable coda contains an obstruent then the following onset must also contain an obstruent. To see why these constraints are relevant to schwa, consider the case of *demanderies*, (also discussed by Tranel [1987b]). The constraints in Figure 3 rule out *[dœ.mã.drjõ], since the underlined onset cluster is too complex. The constraint in (57) rules out *[dœ.mã.d.rjõ], where the obstruent *d* is assigned to the preceding syllable to leave an *rj* onset. The remaining two possible pronunciations are [dœ.mã.dœ.rjõ] and [dœ.mã.dri.jõ], as required. (Note that the *ions* suffix has the two forms, [jõ] and [ijõ].)

Now let us consider the case of h-aspiré words. These vowel-initial words do not tolerate a preceding consonant being syllabified into the word-initial onset. What happens to the V.CV and V.OLV constraints when the second vowel is in the first syllable of an h-aspiré word, as we find in *sept haches* [sɛt.aʃ], *[sɛ.taʃ] and *quatre haches* [katra.ʃ], *[kat.raʃ], *[ka.traʃ]? Here, it would appear that Tranel’s analysis breaks down. Our conjecture is that the constraints in (55) and (57) should only apply when the second syllable is not an h-aspiré syllable. So we need to introduce a further distinction in syllable types, introducing *ha-syl* for h-aspiré syllables and *nha-syl* for the rest.

Example 58

$$\text{syl} \Rightarrow \text{ha-syl} \vee \text{nha-syl}$$

Now *ha-syl* is defined as follows:

Example 59

$$\text{ha-syl} \left[\text{ONSET} : \text{elist} \right]$$

Accordingly, the constraints (55) and (57) are refined, so that the second syllable is of the type *nha-syl*. The revised constraints are given in (60).

Example 60

$$\text{a. } \text{onset-max-1}' \equiv \neg \left\langle \dots \underset{\text{phrase}}{\text{syl}} \left[\text{CODA} : \text{nelist} \right] \text{nha-syl} \left[\text{ONS} : \text{elist} \right] \dots \right\rangle$$

$$\text{b. } \text{onset-max-2}' \equiv \neg \left\langle \dots \underset{\text{phrase}}{\text{syl}} \left[\text{CODA} : \langle \dots \text{obs} \dots \rangle \right] \text{nha-syl} \left[\text{ONS} : \neg \langle \dots \text{obs}, \dots \rangle \right] \dots \right\rangle$$

Now, h-aspiré words will be lexically specified as having an initial *ha-syl*. However, we must not specify any more syllable structure than is absolutely necessary. Example 61 displays the required constraint for the word *haut*.

Example 61

$$\text{lexical-sign} \left[\begin{array}{l} \text{PHON :} \\ \text{SYNSEM|CAT : } \textit{noun} \end{array} \right] \textit{phon} \left[\begin{array}{l} \text{SYLS : } \left\langle \begin{array}{l} \textit{ha-syl} \left[\text{NUC : } \langle \boxed{1} \text{ o} \rangle \right] \end{array} \right\rangle \\ \text{SEGS : } \langle \boxed{1} \text{ o} \rangle \end{array} \right]$$

So although syllabification operates at the phrase level rather than the morpheme level (see Example 53), we are still able to impose lexically conditioned constraints on syllable structure directly.

It remains to be shown how this treatment of h-aspiré bears on schwa. Fortunately, Tranel (1987b:94) has provided the example we need. Consider the phrase *dans le haut* [dã.lœ.o]. This contains the word *le* [l(œ)], which is lexically specified as having an optional œ, indicated by parentheses.¹⁷ There are three possible syllabifications, only the last of which is well formed.

Example 62

$$\begin{array}{l} \text{a. } * \left\langle \begin{array}{l} \text{ONS : } \langle \text{d} \rangle \\ \text{NUC : } \langle \text{ã} \rangle \\ \text{CODA : } \langle \rangle \end{array} \right\rangle_{\textit{syl}} \left\langle \begin{array}{l} \text{ONS : } \langle \text{l} \rangle \\ \text{NUC : } \langle \text{o} \rangle \\ \text{CODA : } \langle \rangle \end{array} \right\rangle_{\textit{ha-syl}} \\ \text{b. } * \left\langle \begin{array}{l} \text{ONS : } \langle \text{d} \rangle \\ \text{NUC : } \langle \text{ã} \rangle \\ \text{CODA : } \langle \text{l} \rangle \end{array} \right\rangle_{\textit{syl}} \left(\begin{array}{l} \text{ONSET : } \langle \rangle \\ \text{NUC : } \langle \text{œ} \rangle \\ \text{CODA : } \langle \rangle \end{array} \right)_{\textit{syl}} \left\langle \begin{array}{l} \text{ONSET : } \langle \rangle \\ \text{NUC : } \langle \text{o} \rangle \\ \text{CODA : } \langle \rangle \end{array} \right\rangle_{\textit{ha-syl}} \\ \text{c. } \left\langle \begin{array}{l} \text{ONS : } \langle \text{d} \rangle \\ \text{NUC : } \langle \text{ã} \rangle \\ \text{CODA : } \langle \rangle \end{array} \right\rangle_{\textit{syl}} \left\langle \begin{array}{l} \text{ONSET : } \langle \text{l} \rangle \\ \text{NUC : } \langle \text{œ} \rangle \\ \text{CODA : } \langle \rangle \end{array} \right\rangle_{\textit{syl}} \left\langle \begin{array}{l} \text{ONSET : } \langle \rangle \\ \text{NUC : } \langle \text{o} \rangle \\ \text{CODA : } \langle \rangle \end{array} \right\rangle_{\textit{ha-syl}} \end{array}$$

The syllabification in (62a) is unavailable, since the syllable corresponding to the word *haut* is lexically specified as *ha-syl*, which means that its onset must be an *elist* from (59). The syllabifications in (62b) are likewise unavailable since these both consist of a syllable with a coda followed by a syllable without an onset, in contravention of (60a). This only leaves (62c), which corresponds to the attested form [dã.lœ.o].

We conclude this section with an example derivation for the phrase *on ne se moque pas* [õn.smɔk.pa], which was presented in (51). We assume that at some stage of a derivation, the PHON attribute of a sign is as follows:

Example 63

$$\textit{phon} \left[\text{SEGS : } \langle \text{õ} \rangle \frown \langle \text{n } (\text{œ}) \rangle \frown \langle \text{s } (\text{œ}) \rangle \frown \langle \text{m } \text{ɔ} \text{ k} \rangle \frown \langle \text{p } \text{a} \rangle \right]$$

¹⁷ As stated above, we do not address the phenomenon of elision here; this example shows that an analysis of elision would not require a separate stipulation for h-aspiré words.

When the appropriate grammatical conditions are met, this phonology attribute will be given the type *phrase*. The definition in (53) will accordingly specialize the SYLS attribute. One possible specialization is given in Example 64.

Example 64

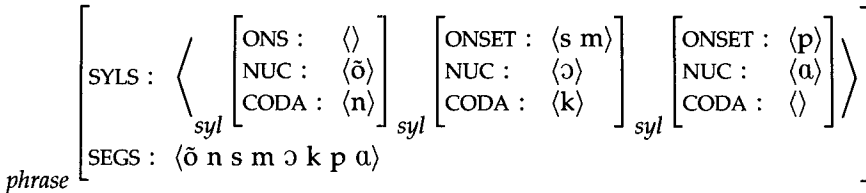

The reader can check that the onset and coda sequences comply with the constraints in Figure 3, that the first syllable can have an empty onset because there is no preceding syllable that could have a coda that matches the requirements of (60a), and that the obstruent *k* is permitted by constraint (60b) to appear in the coda of the second syllable because there is another obstruent *p* in the following onset.

This concludes our discussion of French schwa. We believe our treatment of schwa is empirically equivalent to that of Tranel (1987a), except for the analysis of h-aspiré. Several empirical issues remain, but we are optimistic that further refinements to our proposals will be able to take additional observations on board. Notwithstanding such further developments, we hope to have demonstrated that the procedural devices of deletion and rule ordering are unnecessary in a typed feature-based grammar framework, and that constraints represent a perspicuous way of encoding linguistic observations.

6. Prospects for Implementation

In the preceding sections we have shown how the use of parameterized lists in HPSG is sufficient for encoding a variety of phonological generalizations. While we like this approach for the purposes of specification and exposition, as stated in Section 1.4, we actually envisage an implementation employing finite-state automata for string manipulation. This is simply because we favor the use of existing well-understood technology when it comes to producing an efficient implementation.

As we have already explained in Section 1.4, we have linguistic reasons for not wishing to use finite-state transducers and the concomitant two-level model, and instead are interested in exploring the prospects of integrating our work with the automaton model of Bird and Ellison (1994). In this section we give an overview of this automaton model and briefly outline the view of automata as types that was originally proposed in Bird (1992).

6.1 One-Level Phonology

For a variety of reasons already laid out in Section 1, we would like to achieve a closer integration between phonology and constraint-based grammar frameworks like HPSG. However, for such an integration to work, it is necessary to adopt a rather unusual view of phonology; one characterized by such notions as compositionality, intensionality, and lexicalism, and which has come to be called constraint-based phonology (Bird 1990).

Recently, Bird and Ellison (1994) have reinterpreted the constraint-based approach to phonology using finite-state automata. Nonlinear phonological representations and

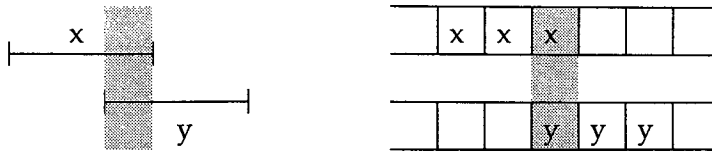

Figure 4
Two views of autosegmental association.

rules are encoded as automata. The key insight is that if autosegmental association is viewed as overlap between intervals with duration (Bird and Klein 1990), then the overlap can be simulated by using synchronization primitives on automata. Figure 4 illustrates this idea. The diagram on the left of Figure 4 shows two temporal intervals *x* and *y* that overlap during the shaded period. On the right, the intervals *x* and *y* themselves are represented as sequences of contiguous tape cells where each cell contains a copy of the appropriate information (here, simply repeats of *x* and *y*). Again, the shaded period indicates the period of ‘overlap’ of the two intervals. The reader is referred to Bird and Ellison (1994) for further details.

Although this kind of phonology employs formal devices very similar to the two-level FST model, there are some important differences in how the two models are used. In the two-level model the traditional distinction in phonology between RULES and REPRESENTATIONS is evident in the transducers and tapes respectively. As in constraint-based grammar more generally, one-level phonology does not have this distinction; rules and representations alike are interpreted as automata. Figure 5 illustrates this difference.

Now that we have outlined the one-level model and briefly discussed its relationship with the two-level model, we shall sketch the link to typed feature systems.

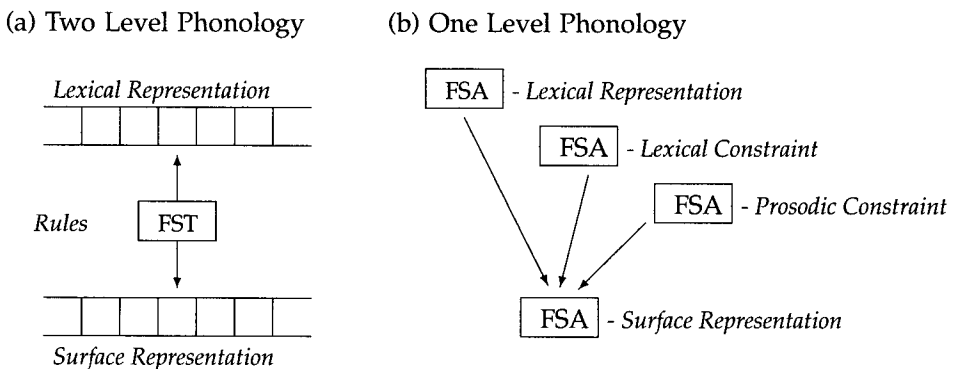

Figure 5
Comparison of two-level and one-level phonology.

6.2 Types as Automata

A type denotes a set of objects. Thus, types are descriptions, and they can be combined using the familiar operations of meet, join, and negation. Similarly, an automaton denotes a set of objects, namely strings (or automaton tapes). And likewise, the operations of meet, join, and negation are defined for automata and correspond to intersection, union, and complement of the corresponding sets. Of course, a further operation of concatenation is defined for automata. We envisage a system for processing linguistic descriptions that implements a subset of the types (which we might simply call STRING types) as finite-state automata over some predefined alphabet. When the inference engine requires that two string types be 'unified,' the meet of the corresponding automata will be formed.

Although these string types may be declared as the appropriate values for certain attributes in a typed feature system, string types are only declared in terms of the basic alphabet and other string types. It is not possible to employ non-string types in the definition of string types. This is a severe restriction, since list types (say, in HPSG) allow arbitrary feature structures as elements, and we would like to be able to do the same for string types. Work on overcoming this limitation is currently in progress, and builds on the well-known similarity between feature structures and automata, when viewed as directed graphs (Kasper and Rounds 1986).

7. Conclusion

In this paper, we have tried to give the reader an impression of how two rather different phonological phenomena can be given a declarative encoding in a constraint-based grammar. Although we have focused on phonology, we have also placed our analyses within a morphological context as befits the multi-dimensional perspective of HPSG.

The formal framework of HPSG is rather powerful; certainly powerful enough to capture many analyses in the style of classical generative phonology in which arbitrary mappings are allowed between underlying and surface representations. We have limited ourselves further by allowing only one phonological stratum in the grammar, and by adopting a notion of phonological compositionality that supports monotonicity. These restrictions make it much harder to carry over generalizations that depended on a procedural rule format. This is not a handicap, we contend, since it is heuristically valuable to view the data in a new light rather than just coercing traditional analyses into a modern grammar formalism.

So what is a constraint-based style of phonological analysis? An important key, we claim, is the use of generalizations expressed at the level of prosodic types. Coupled with a systematic underspecification of lexical entries and a regime of type inheritance, this allows us to have different levels of linguistic abstraction while maintaining a 'concrete' relation between lexical and surface representations of phonology.

We hope to have given enough illustration to show that our approach is viable. In future, we wish to extend these same techniques to a typologically diverse range of other linguistic phenomena. A second important goal is to show how the technology of finite-state automata can be invoked to deal with phonological information in HPSG. For although we have placed phonology within a general framework of linguistic constraints, the analyses we have presented only involve manipulation of regular expressions.

Acknowledgments

This research is funded by the U.K. Science and Engineering Research Council, under

grant GR/G-22084 *Computational Phonology: A Constraint-Based Approach*, and has been carried out as part of the research program

of the Human Communication Research Centre, supported by the U.K. Economic and Social Research Council. We are grateful to Ted Briscoe, Tomaz Erjavec, Danièle Godard, John Nerbonne, Marc Plenat, Bernard Tranel, and Ivan Sag for discussions and correspondence relating to this work, and to two anonymous reviewers for their helpful suggestions.

References

- Anderson, S. R. (1992). *A-Morphous Morphology*, Volume 62 of *Cambridge Studies in Linguistics*. Cambridge University Press.
- Antworth, E. (1990). *PC-KIMMO: A Two-Level Processor for Morphological Analysis*. Summer Institute of Linguistics.
- Archangeli, D., and Pulleyblank, D. (1989). "Yoruba vowel harmony." *Linguistic Inquiry*, 20, 173–217.
- Bach, E., and Wheeler, D. W. (1981). "Montague phonology: A first approximation." *University of Massachusetts Occasional Papers in Linguistics*, 7, 27–45.
- Bird, S. (1990). *Constraint-based phonology*. Doctoral dissertation, University of Edinburgh. To be published in revised form by Cambridge University Press, *Studies in Natural Language Processing*.
- Bird, S. (1992). "Finite-state phonology in HPSG." In *Proceedings of the 14th International Conference on Computational Linguistics (COLING-92)*. 74–80.
- Bird, S., and Ellison, T. M. (1994). "One-level phonology: Autosegmental representations and rules as finite automata." *Computational Linguistics*, 20, 55–90.
- Bird, S., and Klein, E. (1990). "Phonological events." *Journal of Linguistics*, 26, 33–56.
- Bird, S., and Ladd, D. R. (1991). "Presenting autosegmental phonology." *Journal of Linguistics*, 27, 193–210.
- Bloomfield, L. (1926). "A set of postulates for the science of language." *Language*, 2, 153–164. Reprinted in *Readings in Linguistics I: The Development of Descriptive Linguistics in America 1925–56*, edited by Martin Joos. 26–31.
- Briscoe, T. (1991). "Lexical issues in natural language processing." In *Natural Language and Speech*, edited by E. Klein and F. Veltman, 39–68. Springer-Verlag.
- Bromberger, S., and Halle, M. (1989). "Why phonology is different." *Linguistic Inquiry*, 20, 51–70.
- Cahill, L. J. (1990). "Syllable-based morphology." In *Proceedings, 13th International Conference on Computational Linguistics, Volume 3*, edited by H. Karlgren, 48–53.
- Carpenter, B. (1992). *The Logic of Typed Feature Structures*. Volume 32 of *Cambridge Tracts in Theoretical Computer Science*. Cambridge University Press.
- Clements, G. (1985). "The geometry of phonological features." *Phonology Yearbook*, 2, 225–252.
- Clements, G. N., and Keyser, S. J. (1983). *CV Phonology: A Generative Theory of the Syllable*. MIT Press.
- Coleman, J. S. (1991). *Phonological representations—their names, forms and powers*. Doctoral dissertation, University of York.
- Coleman, J. S. (1992). "The phonetic interpretation of headed phonological structures containing overlapping constituents." *Phonology*, 9, 1–44.
- Copestake, A.; Sanfilippo, A.; Briscoe, T.; and de Paiva, V. (in press). "The ACQUILEX LKB: An introduction." In *Default Inheritance in Unification Based Approaches to the Lexicon*, edited by T. Briscoe, A. Copestake, and V. de Paiva. Cambridge University Press.
- Dell, F. (1980). *Generative Phonology and French Phonology*. Cambridge University Press.
- Emele, M. C., and Zajac, R. (1990). "Typed unification grammars." In *Proceedings, 13th International Conference on Computational Linguistics*. 293–298.
- Gazdar, G.; Klein, E.; Pullum, G.; and Sag, I. (1985). *Generalized Phrase Structure Grammar*. Blackwell.
- Goldsmith, J. (1990). *Autosegmental and Metrical Phonology*. Blackwell.
- Goldsmith, J. A. (1993). "Harmonic phonology." In *The Last Phonological Rule: Reflections on Constraints and Derivations*, edited by J. A. Goldsmith, 21–60. University of Chicago Press.
- Hoeksema, J., and Janda, R. (1988). "Implications of process morphology for categorial grammar." In *Categorial Grammars and Natural Language Structures*, edited by R. T. Oehrle, E. Bach, and D. W. Wheeler, 199–247. Reidel.
- Hooper, J. (1976). *An Introduction to Natural Generative Phonology*. Academic Press.
- Hudson, G. (1980). "Automatic alternations in non-transformational phonology." *Language*, 56, 94–125.
- Jaffar, J., and Lassez, J.-L. (1987). "Constraint logic programming." In *ACM Symposium on Principles of Programming Languages*, 111–119.
- Johnson, M. (1988). *Attribute-value logic and*

- the theory of grammar*. Doctoral dissertation, Stanford University.
- Kahn, D. (1976). *Syllable-based Generalizations in English Phonology*. Indiana University Linguistics Club.
- Kaplan, R. M., and Bresnan, J. (1982). "Lexical-Functional Grammar: A formal system for grammatical representation." In *The Mental Representation of Grammatical Relations*, edited by J. Bresnan. MIT Press.
- Kasper, R. T., and Rounds, W. C. (1986). "A logical semantics for feature structures." In *Proceedings, 24th Annual Meeting of the Association for Computational Linguistics*. 257–266.
- Kay, M. (1987). "Nonconcatenative finite-state morphology." In *Proceedings, Third Meeting of the European Chapter of the Association for Computational Linguistics*. 2–10.
- Keating, P. (1984). "Phonetic and phonological representation of stop consonant voicing." *Language*, 60, 286–319.
- Kenstowicz, M., and Kisseberth, C. (1979). *Generative Phonology: Description and Theory*. Academic Press.
- Kiparsky, P. (1982). *Lexical Morphology and Phonology*. Hanshin Publishing Co.
- Kisseberth, C. W. (1970). "On the functional unity of phonological rules." *Linguistic Inquiry*, 1, 291–306.
- Klein, E. (1992). "Data types in computational phonology." In *Proceedings, 14th International Conference on Computational Linguistics (COLING-92)*. 149–155.
- Klein, E. (1993). "An HPSG approach to Sierra Miwok verb stems." In *Phonology and Computation*, edited by T. M. Ellison and J. M. Scobbie. University of Edinburgh, 19–35.
- Kornai, A. (1991). *Formal phonology*. Doctoral dissertation, Stanford University.
- Koskenniemi, K. (1983). *Two-level morphology: A general computational model for word-form recognition and production*. Doctoral dissertation, University of Helsinki.
- Krieger, H.-U., and Nerbonne, J. (in press). "Feature-based inheritance networks for computational lexicons." In *Default Inheritance in Unification Based Approaches to the Lexicon*, edited by T. Briscoe, A. Copestake, and V. de Paiva. Cambridge University Press.
- Krieger, H.-U.; Pirker, H.; and Nerbonne, J. (1993). "Feature-based allomorphy." In *Proceedings, 31st Annual Meeting of the Association for Computational Linguistics*, 140–147.
- Manaster Ramer, A. (1981). *How abstruse is phonology?* Doctoral dissertation, University of Chicago.
- Martinet, A. (1972). "La nature phonologique d'e caduc." In *Papers in Linguistics and Phonetics to the Memory of Pierre Delattre*, edited by A. Valdman. Mouton.
- Mastroianni, M. (1993). *Attribute Logic Phonology*. CMU-LCL 93-4, Carnegie Mellon University.
- McCarthy, J. (1981). "A prosodic theory of non-concatenative morphology." *Linguistic Inquiry*, 12, 373–418.
- McCarthy, J., and Prince, A. (1993). "Prosodic morphology I—Constraint interaction and satisfaction." Unpublished Report.
- Morin, Y.-C. (1978). "The status of mute 'e'." *Studies in French Linguistics*, 1, 79–140.
- Morin, Y.-C. (1987). "French data and phonological theory." *Linguistics*, 25, 815–843.
- Paradis, C. (1988). "On constraints and repair strategies." *The Linguistic Review*, 6, 71–97.
- Partee, B. H. (1979). "Montague grammar and the well-formedness constraint." In *Syntax and Semantics 10: Selections from the Third Groningen Round Table*, edited by F. Heny and H. Schnelle, 275–313. Academic Press.
- Pierrehumbert, J. (1990). "Phonological and phonetic representation." *Journal of Phonetics*, 18, 375–394.
- Pollard, C., and Sag, I. (1987). *Information-Based Syntax and Semantics*. Volume 13 of *CSLI Lecture Notes*. Stanford: Center for the Study of Language and Information.
- Prince, A. S., and Smolensky, P. (1993). "Optimality theory: Constraint interaction in generative grammar." Technical Report 2, Center for Cognitive Science, Rutgers University.
- Pullum, G. K., and Zwicky, A. M. (1984). "The syntax-phonology boundary and current syntactic theories." In *Ohio State University Working Papers in Linguistics: Papers on Morphology*, edited by A. Zwicky and R. Wallace. Ohio State University.
- Reinhard, S., and Gibbon, D. (1991). "Prosodic inheritance and morphological generalizations." In *Proceedings, 5th European ACL Meeting*, 131–136.
- Riehemann, S. (1992). *Word formation in lexical type hierarchies: A case study of bar-adjectives in German*. Master's thesis, Department of Linguistics, University of Tübingen.
- Root, M. (1985). *Association with focus*. Doctoral dissertation, University of Massachusetts-Amherst.

- Russell, K. (1993). *A constraint-based approach to phonology*. Doctoral dissertation, University of Southern California.
- Scobbie, J. (1991). *Attribute-value phonology*. Doctoral dissertation, University of Edinburgh.
- Selkirk, E. (1984). *Phonology and Syntax*. MIT Press.
- Shibatani, M. (1973). "The role of surface phonetic constraints in generative phonology." *Language*, 49, 87–106.
- Smolka, G. (1992). "Feature constraint logics for unification grammars." *Journal of Logic Programming*, 12, 51–87.
- Sproat, R. (1992). *Morphology and Computation*. Natural Language Processing. MIT Press.
- Sproat, R., and Brunson, B. (1987). "Constituent-based morphological parsing: A new approach to the problem of word-recognition." In *Proceedings, 25th Annual Meeting of the Association for Computational Linguistics*. 65–72.
- Tranel, B. (1987a). "French schwa and nonlinear phonology." *Linguistics*, 25, 845–866.
- Tranel, B. (1987b). *The Sounds of French—An Introduction*. Cambridge University Press.
- Valdman, A. (1976). *Introduction to French Phonology and Morphology*. Newbury House.
- Walther, M. (1992). *Deklarative Silbifizierung in einem constraintbasierten Grammatikformalismus*. Master's thesis, University of Stuttgart.
- Wheeler, D. (1981). *Aspects of a Categorical Theory of Phonology*. Doctoral dissertation, University of Massachusetts-Amherst.
- Wiebe, B. (1992). *Modelling autosegmental phonology with multi-tape finite state transducers*. Master's thesis, Simon Fraser University.
- Zajac, R. (1992). "Inheritance and constraint-based grammar formalisms." *Computational Linguistics*, 18, 159–182.
- Zajac, R. (in press). "Issues in the design of a language for representing linguistic information based on inheritance and feature structures." In *Default Inheritance in Unification Based Approaches to the Lexicon*, edited by T. Briscoe, A. Copestake, and V. de Paiva. Cambridge University Press.