

# Logical Operators and Quantifiers in Natural Language

Shin-ichiro KAMEI and Kazunori MURAKI

C&C Media Research Laboratories, NEC Corporation  
4-1-1, Miyazaki, Miyamae-ku, Kawasaki, 216 JAPAN  
kamei@hum.cl.nec.co.jp, k-muraki@hum.cl.nec.co.jp

## abstract

This paper investigates negations in natural language, comparing natural language and first-order logic, and it introduces a model for describing quantifiers and negations in natural language. The model consists of the semantic representation of quantifiers such as 'all' and 'some,' and logical operators such as entailment between these words and their negation. The basic framework of semantic representation is a pair of lists, which is called a 'dual list.' Each list includes conceptual elements. The upper list represents a 'literal' meaning of a word, and the lower represents a 'possible' meaning. Logical operations such as entailment and negation are defined on the dual list. The model can handle a wide range of linguistic phenomena, which are related to numbers such as 'three,' and conjunctions such as 'and' and 'or,' as well as qualities such as 'all' 'some' and 'no.' The negation operation on the dual lists consistently generates all possible interpretations for these words. Words such as 'all' and 'some,' and 'and' and 'or' correspond to logical operators in a sense, but they are different in some other aspects. This model, especially its negation process, clarifies the similarities and differences between logic and natural language.

## 1 Introduction

In natural language, there are many curious phenomena which are difficult to explain from the viewpoint of usual first-order logic. Let us consider the following sentence, which includes a numeral, as an example.

- (1) I solved three of the problems.

A natural interpretation of this sentence is "I solved just three of the problems, not all or four or two or one or none of them." However, in a logical way, this statement is true, when "I solved FOUR of them." For example, if the border line between success and failure of a test is three, this sentence is naturally spoken, even when, in fact, the person solved four of the problems (Chomsky, 1972; Ota, 1980; Ikeuchi, 1985). This phenomenon suggests that more complex states than just 'three' for the meaning of the number three are needed to understand natural language.

The following is a Yes/No question corresponding to sentence (1) and its answers. Interestingly, both of the answers below are possible in this case (Ota, 1980; Ikeuchi,

1985). The fact that both Yes and No answers are possible for the same situation suggests the 'duality' of number concepts.

- (2) A: Did you solve three of the problems ?  
B: – Yes, in fact I solved four.  
– No, I solved four.

In addition, let us think of a negative sentence which corresponds to sentence (1). It is well known that a negative sentence like this can have several interpretations.

- (3) I didn't solve three of the problems.

One possible interpretation of sentence (3) is that there are three problems that "I did not solve." Another interpretation of this sentence is that some of the problems were solved, but that the number did not reach three. In addition, an interpretation that the number of solved problems exceed three is also possible. What is important here is that these interpretations are all related to the negation of the number. This phenomenon also suggests the concept 'three' in natural language has to be more complex than just the number 'three' in mathematics.

Similar interesting phenomena are known for quantifiers such as 'all' and 'some,' and conjunctions such as 'and' and 'or.' These words in a sense are similar to operators in logic, that is,  $\forall$   $\exists$   $\wedge$  and  $\vee$ . However, they are definitely different in many other cases, especially in negation processes.

The facts described above have already been pointed out by previous research but these phenomena have not been treated satisfactorily. This paper compares natural language and logic, and introduces a model to describe phenomena which are related to the words above and negations in natural language. The model describes, explains, and calculates the possible interpretations of a wide range of affirmative, interrogative, and negative sentences in a consistent and visible way, and clarifies the similarities and differences between natural language and logic.

## 2 The Dual List Model

### 2.1 Dual List Expression

This section introduce the basic conceptual representation of the model, i.e. the dual list. This representation is introduced for number concepts, but is applied to a wide range of concepts such as 'all' and 'some,' and 'and' and 'or.'

As we have seen in the previous section, the number part of sentence (1) seems to be expressed by more complex representations than just the mathematical number.

- (1) I solved three of the problems.

The authors think that five states are actually needed for clarity: (i) All problems are solved, (ii) the number of solved problems exceeds the number in the sentence (=three in this case), (iii) the number of solved problems is exactly the number in the sentence, (iv) the number of solved problems does not total the number in the sentence, and (v)

no problems are solved. The authors introduce five primitives, 'A,' '>n,' '=n,' '<n,' and 'N,' which are abstracted from the above five states.

In order to describe the actual meanings of these states, a list of these primitives is used. The five primitives are arranged in a list.

$$(4) \{A, >n, =n, <n, N\}$$

The five states are represented by the relative positions shown in Table 1. The authors think that the meanings of words are identified by their relative positions in the list expression. In these lists, '-' means that the value in that particular position is lacking.

Table 1: five states for expressing a number

States	{A, >n, =n, <n, N}
all	{A, -, -, -, -}
>three	{-, >n, -, -, -}
three	{-, -, =n, -, -}
<three	{-, -, -, <n, -}
none	{-, -, -, -, N}

The fact that the two answers with Yes and No are both possible for the same situation, exemplified by sentence (2), suggests that the number concept in sentence (1) has a kind of duality. The authors represent the meaning of the number using the following dual list.

$$(5) \begin{Bmatrix} -, -, =n, -, - \\ A, >n, =n, -, - \end{Bmatrix}$$

The upper row (the direct 'literal' meaning in this representation shows the state where the number of solved problems is the number in sentence (1). The lower row (the possible interpretation) expresses the possible numbers of solved problems, when sentence (1) is spoken. For example, this statement is false, when the number of the solved problems is TWO. Logically, however, this statement is TRUE, when the number of solved problems is FOUR.

When this sentence is spoken, its number part conveys meanings which correspond to BOTH the rows in the dual list. That is, meaning is not only indicated by the upper 'direct' row, but also by the lower 'possible' row.

## 2.2 Intersection Operation

This section introduces an intersection operation on the list, and it shows that dual list and intersection operation naturally generate the two possible answers for the same situation, described in utterance (2).

In an affirmative sentence, the upper 'direct' meaning may be dominant. However, in the case of an interrogative sentence, the lower 'possible' meaning plays a more important role. This model explains the two possible answers for utterance (2) in a simple way. In

Fig. 1, the meaning of the question is expressed with a dual list. The meaning of the real situation (the meaning of 'four' here) is expressed with a single list (in the middle), because it is not an interpretation, but a situation. When comparing the upper row of the question and the row expressing the situation 'four,' there is no common value. There is no intersection between them. This corresponds to the answer with 'No.' When comparing the lower 'possible' row and the situation, there is an intersection, that is, the value '>n.' Therefore the answer is 'Yes.' This intersection operation is a simple and natural way to calculate possible answers to a question which includes a number.

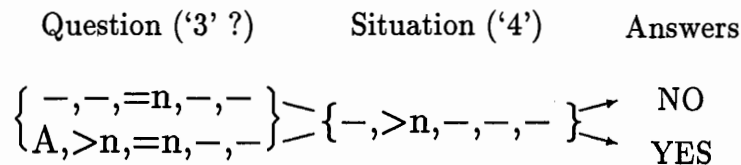

Figure 1: Intersection Operation for Q and A

The difference between the literal meaning and the implications of an utterance is called Conversational Implicature (Grice, 67). The difference between the two rows, 'A' and '>n' in this case, expresses the possibilities of Conversational Implicature.

### 2.3 Negation Operations

This section introduces Negation Operations, which are defined on the dual list representation. Sentence (3) is a negative sentence which corresponds to sentence (1). A negative sentence like this has several interpretations which has been pointed out but which has not been dealt with treat satisfactorily. This model calculates all the possible interpretations of a negative sentence from the representation of the original affirmative sentence.

(3) I didn't solve three of the problems.

One possible interpretation of sentence (3) is that there are three problems that "I did not solve" (Interpretation A). In this interpretation, the number 'three' is not under the influence of negation, that is, the number is out of the scope of negation. To obtain this interpretation, it is not necessary to change the dual list for the original affirmative sentence (5). It is necessary to change the meaning of the values from the number of solved problems to the number of unsolved problems in the representation of the original affirmative sentence (Fig. 2). The lower row expresses the possibility that the number of unsolved problems exceed three.

Where the number (=three in this case) is within the scope of negation, the negative sentence requires other interpretations.

(6) A: Did you solve three of the problems?  
 B: No, I didn't (get to) solve three of the problems.

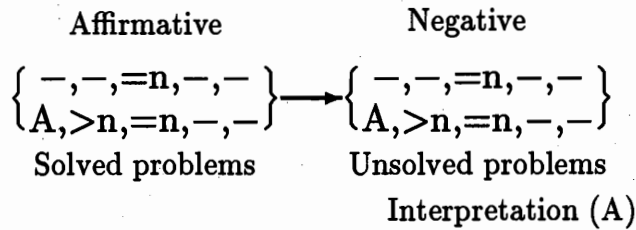

Figure 2: One Negative Interpretation from Affirmative Dual List

—— Interpretation (B)

Response B might mean that some of the problems were solved, but that the number did not reach three. This interpretation can be obtained from the model shown in Fig. 3. The negation operation is shown in Table 2.

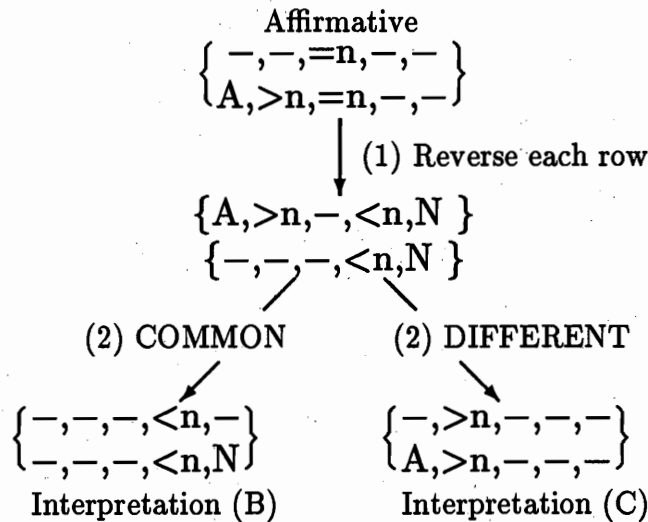

Figure 3: Two Negative Interpretations from Affirmative Dual List

1. Reverse each affirmative row.
2. Select the COMMON part of the two rows.  
The result is a new possible interpretation row.
3. Omit the edge values (A and N).  
The result is a new direct meaning row.

Table 2: Negation Operation for Interpretation B

Step 1 in Table 2 realizes a primitive negation operation on each row. This interpretation of the negative sentence is consistent with the negations of both the direct meaning

and possible implications. Step 2 realizes this condition. This interpretation usually implies that there are some solved problems. This means that negation usually does not deny the existence of solved problems. However, in a logical way, no problem being solved is a possible situation. Step 3 realizes this condition.

- (7) A: Did you solve three of the problems?  
 C: No, I didn't solve **THREE** of the problems: I solved **ALL** of them.

———— Interpretation (C)

The above is a possible utterance, which requires another interpretation. Table 3 shows the procedure to calculate this interpretation (Interpretation (C)).

1. Reverse each affirmative row.
2. Select the DIFFERENT part of the two rows.  
 The result is a new possible interpretation row.
3. Omit the edge values (A and N).  
 The result is a new direct meaning row.

Table 3: Negation Operation for Interpretation C

This interpretation differs from interpretation B, only at Step 2, that is, 'to select the DIFFERENT part of the two rows.' This means that the interpretation is consistent with only the negation of the direct meaning, and it does not satisfy the negation of the possible implications. Step 2 realizes this condition. This exemplifies that the Conversational Implicature can be canceled. In speech, stress is put on **THREE** and **ALL** in this interpretation, and this linguistic phenomenon is accounted for in Step 2.

### 3 Quantifiers in Natural Language

#### 3.1 'All,' 'no,' 'some,' and 'not all'

Here, we will apply the same model introduced in the previous section to the relations between 'all,' 'some,' 'no,' and 'not all' in natural language.

It is well known that sentence (8-1) logically entails sentence (8-2). Sentence (8-2) usually implies sentence (8-3). However, sentence (8-3) contradicts the original sentence (8-1). A careless mixture of logical implication and usual implication in language makes the inference of (8-3) from (8-1) unreasonable (Horn, 1972; Ota, 1980; McCawley, 1981).

- (8-1) All students are intelligent.  
 (8-2) Some students are intelligent.  
 (8-3) Some students are NOT intelligent.

The discrete list model is a useful tool for describing these relations. List (9) is used to express relations between 'all,' 'some,' 'no,' and 'not all (= some ... not).' In this case, three primitives, 'A' 'S' and 'N' are used. These primitives are abstracted from the

meanings of 'all' 'some' and 'no,' respectively. In this list, the value 'S' corresponds to the state wherein there are SOME students who are intelligent and SOME other students who are NOT intelligent.

$$(9) \{A, S, N\}$$

The meanings of these words are also expressed with a dual list. Figure 4 graphically and simply represents the complicated relations among the words.

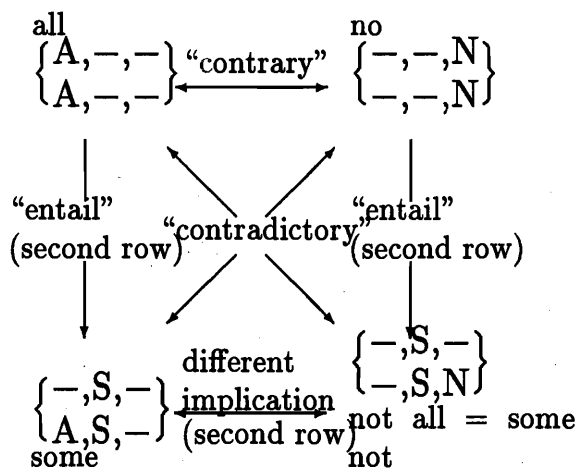

Figure 4: 'All,' 'some,' 'no,' and 'not all'

In Fig. 4, the second 'possible' rows for 'all' and 'some' have an intersection at the value 'A.' 'No' and 'not all' have a similar intersection. This realizes entailment between the two concepts. Figure 4 also expresses the difference between 'contrary' and 'contradictory.' If 'all' is true, 'no' is false. If 'no' is true, 'all' is false. Both expressions cannot be true at the same time. However, these two CAN BE FALSE at the same time, because it is possible that some students are intelligent and some students are not. The term 'contrary' expresses this relation. On the other hand, 'all' and 'not all' have a different relationship. These two cannot be true at the same time, and cannot be false at the same time. 'No' and 'some' have the same constraint. The term 'contradictory' in Fig. 4 expresses this relation.

### 3.2 Negation of Quantifiers

An important point here is that the same operation of negation, Table 2, used for numbers can also obtain the representation of 'not all' from that of 'all' in Fig. 4. The other negation operation, Table 3, produces nothing in this case (Fig. 5). The negation operations are basic and general.

The word 'all' is similar to the operator ' $\forall$ ' in logic, and the word 'some' is similar to ' $\exists$ '. However, the relations concerning the words 'all' and 'some' in natural language are more complicated than the relations between the two operators in logic.

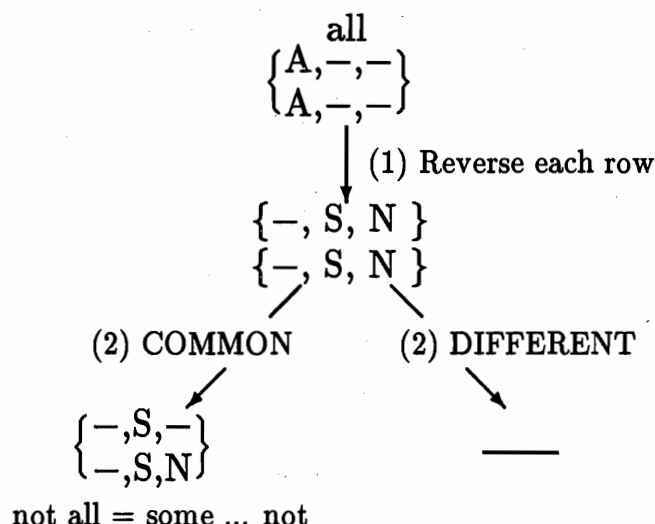

Figure 5: Negation Operation executed on 'ALL'

For example, in the case of logic,  $\neg (\forall A) = \exists \bar{A}$ , and  $\neg (\exists A) = \forall \bar{A}$ . These two relations are symmetric.

It is true that the negation of the word 'all' is 'some ... not,' as described above. Natural language and logic are similar at this point. However, this is not the case with the word 'some' and the operator ' $\exists$ '. The negation of 'some' is difficult to consider in natural language.

The dual list is able to explain this phenomenon. Figure 6 shows negation operations on the word 'some.' Both 'common' and 'different' results have a vacant list as an upper 'direct' meaning. This corresponds to the fact that the negation of 'some' is difficult to consider, while the negation of the logical operator ' $\exists$ ' is easy. The model, that is the dual list, the intersection operation, and the negation operation, is useful and powerful.

## 4 Operators 'AND' and 'OR'

### 4.1 'OR' in Natural Language and 'OR' in Logic

This section applies the same model to the conjunctions 'and' and 'or' in natural language. These words are similar to the logical operators ' $\wedge$ ' (= 'AND') and ' $\vee$ ' (= 'OR'). However, natural language and logic are definitely different. The dual list model clarifies the similarities and differences between natural language and logic.

It has been shown that 'OR' has characteristics similar to degree concepts such as numbers, 'all' and 'some' (Gazdar, 1979). The fact that 'or' in natural language generally has two interpretations, the 'inclusive or' and the 'exclusive or' suggests that the concept of 'or' can be expressed by the dual list.

To express concepts for conjunctions such as 'and' and 'or' in natural language, the authors introduce three states:  $(++)$ ,  $(+/-/+)$ , and  $(--)$ . These primitives are abstracted from the meanings of 'and' 'exclusive or' and 'nor.' A basic list is as follows.



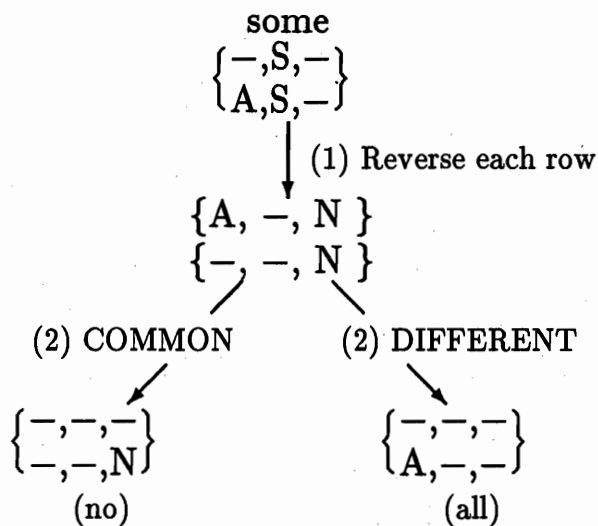

Figure 6: Negation Operation executed on 'SOME'

$$(10) \{((++), (+-/-+), (---))\}$$

The dual lists for 'and' and 'or' are as follows.

$$(11) \text{ and } \left\{ \left( \begin{array}{c} ++ \\ ++ \end{array} \right), \quad - \quad , \quad - \right\}$$

$$(12) \text{ or } \left\{ \begin{array}{c} - \\ ++ \end{array} \right\}, \left( \begin{array}{c} +-/-+ \\ +-/-+ \end{array} \right), \quad - \quad \left\{ \right.$$

'Exclusive or' is a direct meaning of 'or' and 'inclusive or' is a possible interpretation of 'or' in this framework. While 'or' in logic is usually 'inclusive or,' the authors treat 'or' in natural language as the dual list above. In other words, 'or' in natural language means BOTH 'exclusive or' (as a direct or literal meaning) and 'inclusive or' (as a possible meaning).

## 4.2 Negations of 'and' and 'or' in Natural Language

This section calculates the negations of 'and' and 'or' in natural language. Logically, the negation of the logical operation 'OR' (that is, 'Inclusive or') is 'NOR.' However, in a sense in natural language, 'AND' instead of 'NOR' can also be a negation of 'OR.'

It is difficult to conceptualize the negation of 'or' in natural language, in the usual sense, although the negation of 'and' is easy. Figure 9 shows the relationship between the inclusive and exclusive 'or' and their negations.

The same negation operations will produce the two negations for 'or,' that is, both NOR and AND. The direct meaning rows in the two interpretations of negations for 'or'

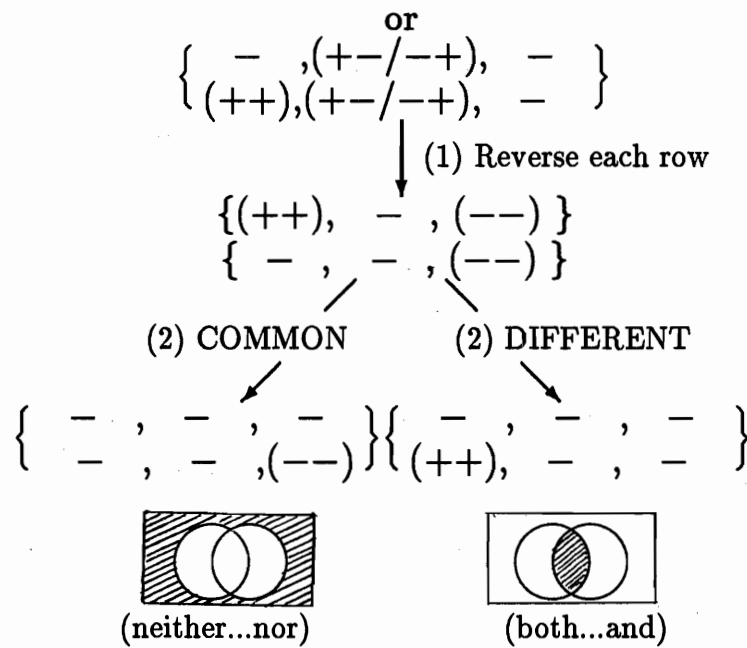

Figure 7: Negation Operation executed on 'OR'

have no values. This corresponds to the fact that it is difficult to consider the negation of 'or' in natural language. Note that the dual list for 'or' and the dual list for 'some' in Fig. 4 have an identical structure. It is equally explained that the negation of 'some' is difficult to conceptualize in natural language, while the negation of 'all' is easy.

## 5 Conclusion

This paper presented a model for negations in natural language. The characteristics of the model are: (1) discrete conceptual primitives, (2) list representation of concepts, (3) dual list representation for possibilities of Conversational Implicature, (4) intersection operation on the list for realizing entailment of two concepts, and (5) negation operations on the dual list to calculate all the possible interpretations of negation of concepts.

The model describes, calculates, and explains a wide range of linguistic phenomena, such as: (1) All possible answers to a question which contains a quantitative word, (2) all possible interpretations of negation of quantitative words, (3) the difficulty of applying negation to some quantitative words, such as 'some' and 'or,' and (4) the relations between 'OR' in logic and 'or' in natural language. These phenomena suggest that the model is able to represent substantial structures in natural language and that it is a suitable tool for natural language understanding.

Since the model uses conceptual elements, and concepts are defined by relative positions using the list, the model can easily be applied to other quantifiers such as 'many,' 'few,' and 'a few' (Kamei and Muraki, 94). The authors hope that this model will become a possible extension of first-order logic for natural language understanding.

## References

- [1] Barwise, J. and R. Cooper (1981). 'Generalized quantifiers and natural language.' *Language and Philosophy* 4.2, pp. 159-219.
- [2] Bolinger, D. L. (1972). *Degree Words*. Mouton.
- [3] Chomsky, N. (1972). *Studies on Semantics in Generative Grammar*. Mouton.
- [4] Fauconnier, G. R. (1975). 'Pragmatic scales and logical structure.' *Linguistic Inquiry* 6, pp. 357-375.
- [5] Gazdar, G. (1979). *Pragmatics: Implicature, Presupposition, and Logical Form*. Academic Press.
- [6] Grice, H. P. (1975). 'Logic and conversation' In P. Cole and J. L. Morgan Eds., *Speech Acts*, pp. 45-58. *Syntax and Semantics* 3. Academic Press.
- [7] Hirschberg, J. B. (1985). 'A Theory of Scalar Implicature' Ph. D. dissertation, University of Pennsylvania.
- [8] Horn, L. R. (1972). 'On the semantic properties of logical operators in English' Reproduced by the Indiana University Linguistics Club (1976).
- [9] Ikeuchi, M. (1985). *Meishi-ku no Gentei Hyougen (Noun Phrase Specifying Expressions)*, (in Japanese). Taishukan.
- [10] Kamei, S. and K. Muraki (1988). On a Model of Degree Expression, (in Japanese). *NLC 88-6*. The Institute of Electronics, Information and Communication Engineers.
- [11] Kamei, S., A. Okumura, and K. Muraki (1990). Syntax of English Adverbs, (in Japanese). *Proceeding of the 40th Conference of Information Processing Society of Japan, Vol. 1*, pp. 417-418.
- [12] Kamei, S., and K. Muraki (1994). A Discrete Model of Degree Concept in Natural Language. *Proceeding of the 15th International Conference of Computational Linguistics, Vol. II*, pp. 775-781.
- [13] McCawley, J. D. (1981). *Everything that Linguists have Always Wanted to Know about Logic but were ashamed to ask*. The University of Chicago Press.
- [14] Ota, A. (1980) *Hitei no Imi (Meanings of Negation)*, (in Japanese). Taishukan.
- [15] Quirk, R., S. Greenbaum, G. Leech, and J. Svartvik. (1985). *A Comprehensive Grammar of the English Language*. Longman.
- [16] Yagi, T. (1987). *Teido Hyougen to Hikaku Kouzou (Degree Expressions and Comparative Structures)*, (in Japanese). Taishukan.