

AUTOMATIC TRANSLATION OF LANGUAGES†

SILVIO CECCATO

Centro di Cibernetica e di Attivita Linguistiche, University of Milan, Italy

1. LANGUAGE AS THE EXPRESSION OF THOUGHT

1.1. *Two approaches to mechanical translation*

In any discussion of MT it is important to make a sharp distinction between two approaches, and two procedures deriving from them; they have grown further apart as they developed, and they are perhaps destined to remain apart for several years in the future, although they share the same name.

On the one hand we speak of mechanical translation, studies for MT, analyses and even grammars for MT in connection with research which is not in the least concerned with the reproduction of the operations involved in human translation, but only with the results—and even the word “results” is used here with several reservations. Basically this is a question of constructing a machine which will enable a person who is not in a position to make use of a text directly, because of his ignorance of the language in which it is written, to discover what the text contains—whether it treats of economics or of ethics, of a railway accident or a political catastrophe. So much the better, of course, if the original text reappears in a form resembling a good human translation. But between the two extremes, any result will be useful and the methods which led to it are irrelevant. This tolerance is understandable, if we bear in mind that the translated text is mainly intended for the eyes of persons competent in the first of which it treats, rather than for a more general public; and such a person is in a position to reconstruct the text and correct errors of translation. Besides, if the results, however lame and distorted, indicate that the text is of real interest to the reader, he can then apply to a person acquainted with both languages (and with the subject concerned) for an accurate translation.

On the other hand we speak of mechanical translation and mean a complex of research primarily aimed at the study of man as a translator, and only secondarily at the construction of a machine which will translate, a machine whose function is also that of a model; that is, it should reproduce as far as possible the operations of a person who translates. And it should be clear how much is involved in studying the procedure of human translation. It involves our embarking on an enquiry which, certainly, is linguistic in scope, but which is very much wider, and deeper too, than is usually implied by this term; an enquiry which requires extensions into the fields of psychology and even of philosophy, enabling us to consider language not merely as a product which we acquire as a datum, but as a process dynamically accompanying the development of our thoughts. A man who is translating is thinking; his understanding of the original text is thinking, and his translated text designates his thoughts. Of course, this enquiry also will lead to the construction of a machine which

† Presented at the NATO Advanced Study Institute, Venice, 15-31 July 1962.

Here, then, is one possible way of mechanizing translation, which would guarantee a rough understanding of a foreign text; and this possibility is certainly within easy reach, because it does not require the solution of any problems, old or new, in psychology, philosophy, or even linguistics; it is only necessary to mechanize an ordinary two-language dictionary, and to expand its list of input words to include all inflected forms, that is, to compile a dictionary which would contain not only a translation of the word "dog" but also of the word "dogs", not only of "to love" but also of "loved", "loves", "loving", and so on. The skill, and the problems, involved in this solution, concern only the builder of the machine, which must be equipped with a memory large enough to contain the equivalents of all the words in the dictionary, and must work at extremely high speeds.

The results of such a word-by-word translation might next be improved if the bilingual dictionary were to be equipped with translations not only of single words but also of frequent combinations of two or three words. It would include, then, not only "cane" translated into English as "dog", but also "cane nero" translated as "black dog", "piccolo cane nero" as "little black dog", and so on. Of course, the number of input units would thus increase enormously, and the work involved in compiling the dictionary, as well as the storage capacity required in the machine, would be correspondingly greater. Going further in this direction, we arrive at the absurd position of feeding into the machine ready-made translations of all the sentences, indeed all the texts, written and not yet written, which the machine may be called upon to deal with.

But in fact, in order to arrive within a reasonably limited time and expenditure at a machine capable of translating, for example the foreign daily press, for the benefit of the civil and military departments which need this information, this type of solution of the problem seems to be, initially, the only practicable one. Accordingly, because of the American government's interest in the Russian press, IBM America has built, under the direction of Dr. Gilbert King, a machine basically of this type; it is already yielding strikingly excellent results. The only thing which now slows up the delivery of translations by this machine is the introduction of texts into the machine, which, in the absence of an adequate automatic reading device, has to rely on inputs supplied by a highly-skilled typist. We also owe to Prof. Leon Dostert, of Georgetown University, a translation procedure which can be applied, for instance, on the 7090 IBM, and which provides useful Russian-English translations; he also uses the principle of direct coupling of the input with the output language. This method is certainly capable of being brought to a very high degree of accuracy, and Dr. King and Prof. Dostert are at present introducing refinements which will further improve the quality of output; but it is not, by its nature, indefinitely perfectible. So that it may turn out, after all, that this type of research is not even the most economical kind; particularly when it is financed by a body such as a Ministry of Education or a National Scientific Research Council, supporting other kinds of research as well; for such a body would gain from MT research remarkably few results of use in any other field of research on human behaviour, from linguistics to physiology.

The other approach, that of constructing a machine which will translate by reproducing the activity of a human translator, gives rise to such hosts of problems that it is extremely difficult to set a limit, of time or of expenditure, to its successful conclusion. What is language? What is a language? What is a sentence? How does the mind operate? What is thinking? What is the relation between language and reality, and between language and thought? We are entering the stronghold of philosophy with these questions; and perhaps for the first time such speculations may prove not wholly innocuous. For people succeed in

thinking and talking and translating quite well, whatever view the philosopher or the psychologist takes of the matter. But here, if the speculative foundations are faulty, sooner or later the research will fail, having first consumed a good deal of time and money.

The undertaking might seem entirely hopeless, then, to anyone who is aware that among the widely diverse and conflicting answers which have been given in the past to such questions, there has been none of a sort which could be used as a basis for the construction of any mechanism, or as the guiding principle of a line of physiological or anatomical research. It is not, be it noted, that the answers given have been *wrong*, in the sense that an actual construction designed in accordance with them would fail to correspond, in its organs or in their functions, with its paradigm, a man thinking and speaking. It is rather that they have been of a sort which excluded the possibility of this kind of verification: they all contain at least one term which is irreducibly metaphorical or negative, and which could only be removed at the cost of introducing a contradiction; and for this reason they are inapplicable as criteria either of construction or of recognition.

1.2. *The study of the mind as a condition for an approach to MT by way of thought*

The Italian Operational School [1], whose findings constitute the basis of the work of the Centro di Cibernetica e di Attività Linguistiche (of the University of Milan and the Consiglio Nazionale delle Ricerche) employs a method of studying the human mind which has made it possible to arrive at results of a sort which can be used both in the construction of a model, and as a working hypothesis for the study of the brain [2-4]. Mechanical translation is only a particular application of these studies.

By virtue of its decisively operational approach [5], and of the extent of the analyses already made during previous enquiries into thought and language, the method adopted by the Centro to solve the problem of MT represents one of the most complete examples of a project for a model of man's superior activities. This is not to say that the machine reproduces in every respect the activities of a man translating; the correspondence is limited in at least three fundamental ways. The first concerns the actual description of the human mind. Although we have been engaged on these problems for some twenty years now, and although about fifteen people now collaborate in the research, the field to be explored appears, and the results already achieved confirm it, extremely vast. The second limitation concerns the mechanizability of the isolated operations—current technical difficulties involved in constructing the organs to carry them out, and requirements, in time and money, for the construction. Lastly, since the Centro's researches are largely financed on a basis of contracts involving specified quantitative results, we have taken certain decisions leading to a compromise.

Let us try now to put this project of mechanical translation into its place in the operational theory from which it is derived. We can do this best by making a brief survey of some of the principal results already arrived at.

(a) *Critique.* The first phase of our research was largely of a critical kind. Of course, things which now appear clearly were at first only glimpsed, concealed and distorted by a speculative tradition of long standing which taught that the brain should be considered not in terms of organs and their functions, but as the passive mirror of the events around it. These events were to be found inside the brain as duplicates of things outside it. But this duplication creates difficulties. The external event and its duplicate are supposed to be the same, yet they must also be different, since the external event may be substantial, material, bodily, while the internal event cannot have any substance, if it is to be accommodated in

a head already full of its own anatomical pieces. Internal events therefore lack at least the physicality of their external counterparts; in at least one respect, then, they have to be described negatively, so as to give rise to the so-called abstract entities. To take a famous example: volume is an abstract, obtained by depriving a body of its physicality; surface is more abstract still, depriving volume of thickness or depth; a line is obtained by depriving a surface of its width, and the most abstract of all is the point, deprived even of the possibility of having parts.

The irreducibility of the metaphor, of which we spoke earlier, arises from the very idea of duplication, of mirroring: if only because the metaphor holds good in situations where both the original object and its reflection are present to us for comparison, whereas in the case of the "reflections" or "duplicates" in our head, the original can never be present.

Hence, it was necessary to set up defences against this speculative tradition, and to demonstrate the error it contained, in order to clear the way, at least programmatically, for a course of research which might result in descriptions useful to the anatomist, the physiologist, and the engineer.

The discovery of the error is anything but easy, because we are led to examine the problem from a point of view which itself embodies the same error; it is as if, in order to find out what distortion of our vision was caused by wearing a certain pair of spectacles, we tried replacing them with another identical pair. This realization was slow to develop in our minds. A determining factor was the observation that, of a thing which remains the same in its form and material, we often speak in different and even contradictory ways. We may speak of a cup, for instance, as a part (in relation to the tea-service) and yet as a whole (in relation to its handle, rim, and so on). We may regard a fingernail as the beginning of a finger, or as its end. And so on. We concluded from this that at least some of the things which we designate by words are quite independent of the bodies in our environment, and cannot thus represent a duplication; instead, they arise from operations which we ourselves perform. Thus, at least, a crack was opened in the tradition built on the duplication of objects and their presence in us as abstract entities; and having embarked on dismantling certain designated things into operations, it seemed reasonable to try to apply the same type of analysis to all designated things in general.

In the meantime we succeeded, also, in finding out how the tradition of duplication of objects may have arisen. For the ordinary requirements of life, we chiefly need to know what relationships obtain between observed things: relations of cause and effect, of appurtenance, of space, of time, and so on. It helps us to know that fire heats water and that water quenches fire; that the seed is contained in the fruit and that the fruit contains the seed; that a particular mountain is near, or far from, a particular river; that the vibration of a cord produces a sound and that sounds can cause cords to vibrate, etc.

We may assume that men have directed their attention towards such things for thousands of years, accumulating this type of knowledge with great success and acquiring the ability and the habit of looking at things in this way.

But all this conscious or unconscious research takes place when the things involved have already been perceived, and never has occasion to pause and consider the activity of perception itself. How we hear the sound, or how we see the cord or its vibrations, these questions never arose.

It is not surprising, then, that when, impelled by pure curiosity, as philosophers, or for more practical reasons, for example medical ones, people came to consider these questions, the technique and the habit which had always worked so well came to be applied in this

new field too; and thus the perception of objects was explained in terms of relationship between the objects perceived and another perceived object, individuated as the body of the perceiver; and the relations involved were supposed to be of the same type: cause and effect, and so on.

On the other hand, since the object perceived is one only, when it had been localized once in its own place, and once inside the human body, there arose the theory of duplication, and of a new kind of activity for man, or for the perceived object, or for God the creator of both: an activity such that one object became a copy of the other, and both were the same except for their different localizations.

It seems probable that two other factors inclined us to mistake the activity of perception for an activity between percepts.

The first springs from the relation which obtains between most of our verbs and their objects; the objects are modified by the activity designated by the verb, and must therefore exist, previous to the activity, in their unmodified form. This is the case, for example, when we heat water, dig the ground, embroider cloth, and so on. We then incline to interpret in a similar way situations in which the object is not the raw material of the activity, but its result; when it exists after the activity, but not before. This is the case in situations such as: to dig a hole, to embroider a flower, and so on; but it is also the case with all verbs of perception, such as to see, to hear, and so on. When situations of this type are confused with those of the first type, the result is, precisely, the duplication of the object of the activity, since the activity cannot produce it, because it already exists, and cannot modify it, because it already exists exactly as it is and as nothing else.

The second factor lies in the nature of the activity of perceiving, and, in general, of all mental activities. These activities, though only for technical and contingent reasons, have never yet been observable in terms of the functioning of any organ; they do not manifest themselves through any effort we make; they are learnt in earliest childhood, without the conscious attention of the adult; and they are carried out with a rapidity which makes them appear instantaneous, and thus deprives them of the characteristic of activities. Only a person who is born blind and gains his sight when he is an adult is aware that visual observation is a long and laborious task. It is not surprising, then, if the activity of perception has, as an activity, escaped us, and has been interpreted instead as the passive reflection of a mirror.

But however it arose, the idea of the duplication of the objects of perception has had notable repercussions in every field of thought. Consider philosophy, which was set up to explain this duplication and the activity which was to reunite the perceiving subject, the "knower", with the perceived object, the "known". Owing to this activity of "knowing", all the contents of thought were expected to display the characteristics of perceived objects; and thus their analysis was to result in an articulation of the object into elements characteristic of perceived things, colours, sounds, etc., and sometimes forms. And consider the theories of knowledge, the methodologies, the logics of scientific enquiry intended to justify and to guarantee these impossible analyses.

These problems have an unmistakable character of their own. For example, if the presence of things in ourselves is a result of the presence of the same things outside us, how are we to explain the presence in us of things which, since they are not physical things, cannot occupy any place outside us? The philosopher must try then to account for them as properties of physical objects; but, apart from the difficulty of finding them among the properties of physical objects, what is he going to do about relations? Above all, what is

to be done about the categories of time and space, which cannot conceivably be duplicated? And when Kant tries to save the situation by assigning different origins to physical things and to some categories, how are the two kinds of things to be recombined?

For our present purposes we shall confine ourselves to showing some of the effects the theory of the duplication of the objects of perception has had on the study of language. Words, in order to be words and not merely sounds, marks or gestures, must be connected with something else, must refer to something else. This reference is easily discovered when the words designate physical things; but what is the reference of words concerned with relations or categories which do not admit of physical existence? They have to be regarded as *flatus vocis*, or empty words, to which no designated thing corresponds, which is blatantly contradictory; or as words which designate values of designation of other words, and so on; in either case language is broken into two parts which have no homogeneity of designation, and cannot therefore be studied in terms of this function of designation, which is in fact the only constitutive function of language.

Further, it becomes impossible to grasp the difference between the signifying function of a sentence and that of a single word, and, accordingly, of the relations between these two fundamental units of discourse. It becomes impossible, that is, to explain the difference between a sequence of detached words such as “and”, “and”, “or”, “sing”, and, for instance, the sentence “and and or are relations”. To explain this difference one must employ the concept of the temporal structure characteristic of thought; but this, as we shall see, is not possible as long as thought is conceived of within the framework of the theory of duplication.

If we bear in mind that, at least at present, in the absence of better techniques of inspection, the most fruitful and least fanciful way of approaching the study of the mind is through language, it becomes clear in what way the interrupted and distorted analysis of language has had a paralysing effect on the various attempts to individuate our superior activities and their organs. And in the special case of MT, it is also easy to understand that, apart from immediate practical aims, a solution which would examine the operations of a man who translates, and who in order to translate understands and therefore thinks, was immediately considered impossible. It is certainly the case that between a line of speculation based on the epistemological premises derived from the duplication of the objects of perception on the one hand, and any kind of technical enquiry either descriptive or constructive on the other, there lies an unbridgable gulf.

(b) *Construction.* When we succeeded in getting rid of this philosophical tradition and began to glimpse the possibility of analysing all designated things in terms of operations, the actual analysis, of course, did not yet exist. But even when planning research in operational terms, we saw that the unavoidable deadlocks of the philosophical tradition would resolve themselves one by one, and we realized that from there on our work would require only great patience and the cultivation of a flair for this type of analysis. At the beginning of the analyses, besides, we set no limit to which the analysis of each item had to be pushed; we were satisfied if the articulation of the thing under analysis in some way made clear the dynamic construction of the thing. Whereas arrival at such a pre-established limit became one of the main requirements later, when we were planning to use the results of our analyses in the construction of models which should *repeat* the isolated and described operations. It was necessary, in fact, that the analysis should always lead to technologically feasible operations, that is, certain changes of state or of place, and combinations of these. Even the metamorphosis of Daphne into a laurel can be presented as a sequence of changes of

state and place, but it could scarcely be achieved in practice by present-day technology. In a linguistic machine, then, changes of state or place, and their combinations, must constitute all nominated things, whether these correspond to single words or to sentences, or to larger units such as a complete discourse.

It would take too long to describe how our analyses developed from the first operational articulations into those which the Centro now employs in its different projects: mechanical translation, which we shall discuss further, mechanical summarizing, and mechanical observation and description. Here we can only sketch briefly the four orders of operations in terms of which the working of the mind has been described in such a way that it is technically possible to construct organs to perform them.

However, there is one other point to be stressed. In speaking of our models we shall use the terms "organs" and "functions". This is legitimate terminology, certainly, provided that we bear in mind a fundamental distinction in this respect between a model and a man. The distinction between organs and functions, as it is usually applied to machines, tends to attribute all differences in the machine to its functioning, while the organs remain unaltered: that is, a machine usually has no monotonic functions save those of running-in and of wear. To correspond to memory, then, which in man is perhaps the most important of the monotonic functions, it is necessary to introduce special organs in addition to the cyclic organs of the machine. But this is obviously only an imitation of operating matter characteristic of living beings, memorizing matter, capable, that is, of repeating operations it has once carried out simply by virtue of having once carried them out; matter which is built up by its operations, so that it can be taken as justifying the statement (contradictory in its terms, as it would seem), that "the function creates the organ". In other words, this amounts to the admission that our models may carry out some of men's operations, but that these operations are inserted beforehand into the stable material of the organs, in an organism which in order to develop must be provided *ad hoc* with an organ in which this development is also inserted beforehand into its stable material. This limitation, of course, derives from the current technical difficulties involved in constructing operating, memorizing matter, which would reproduce living matter.

The four orders of operations isolated as constitutive of human superior activities are these: differentiation, figuration, categorization and thought.

Differentiation is produced by changes of state. Each differentiation is constituted, of course, not by one state but by the change from one state to another; it is characterized by two states and the direction of the transition between them.

By differentiation we obtain the things designated by words like "dark", "light", "hot", "cold", "resistant", "yielding", "silence", "noise", etc. The things nominated by these words, however, often contain more than the results of differentiation alone; they include, as we shall see, certain results of categorization as well.

Since we have taken differentiation as the elementary component operation, its analysis into other operations is *ipso facto* ruled out. This, however, does not prevent us from outlining a differentiatum by indicating, for example, its opposite, that is, the differentiatum obtained from the same two states taken in the reverse order; or by indicating the circumstances under which the particular change of state occurs, that is, by indicating the *dependences* of the functioning of the organ. In this way it is possible to say that noise occurs when bodies vibrate, and silence when vibration ceases; and so on. But it would be wholly wrong to identify the differentiatum with its conditions, to identify "noise" with the vibration of bodies, and so on.

Differentiation, it should be remembered, is not in itself *sensation*: one thing corresponds to “hot” and another to “sensation of hot(ness)”; to get from differentiation to sensation, it is necessary to add the categorization of “subject”, and this is a categorization which, like any other operation, is facultative; that is, it may or may not be made. This analysis brings out the way in which the constitutive activity of sensation is distinguished sharply from what the tradition of duplication has made of it, a process of mirroring, and an irreducible point of departure.

Figuration is obtained by changes of place. Each figure is constituted by a change of place, not by a single place; as with differentiation, it arises from two places and the direction of the transition between them. Most figures, however, are made up of many changes of place. From figuration we obtain things which do not, as a rule, receive designations of their own; they are usually combined with differentia before receiving a designation (especially in the activities of perception and representation, as we shall see later). Although we may find in one language that there exist both a word “egg” and a word “oval”, both a word “lance” and a word “lanceolate”, and so on, in most cases there is no single word to designate the figure, as such, of the perceived object, such as “apple”, “tree”, “dog”, “horse”, “house”, and so on. Most of the figures which we recognize and designate in isolation as figures belong to geometry: “circle”, “triangle”, “Ellipse”, and so forth.

Moreover, the figures we designate, either in isolation or together with differentia, are very rarely constituted by a single change of place. Usually the figure is the result of the combination of many such changes, which constitute the *traces* (Italian “tratti”, or French “traits”), or the elements of the figure. The trace, taken as the result of one change of place, presents the same unanalysability as the differentiatum; but most figures are fairly readily analysed into their constitutive traces.

Categorization is obtained from combinations of a special kind of differentiatum, the differentiatum of consciousness, attention, or presence. This is the differentiatum with which, for instance, we react to exclamations like “look!”, “listen!”, and so on. We obtain combinations of this by way of the two-fold possibility open to us, of either maintaining the constituted differentiatum, that is, prolonging the second state involved in the change of state, or alternatively leaving behind the constituted differentiatum and going back to the initial state. If the differentiatum of presence is maintained, or prolonged, while one goes on to make a second differentiatum of presence, the two differentia will be temporally overlapping; and this gives rise to the simplest of the combinations of presence, or categorial or logical combinations. This first combination corresponds to a state of attention which, from being unfocussed, becomes focussed; it is obtained when, for instance, we react first to the word “look!” and then to the word “there!”. Taken in isolation, this first combination is designated in English by the word “thing”, as in “something”, (in Italian by “qualcosa”, in German by “Etwas”).

From categorization we obtain the things designated by words like “or”, “and”, “not”, “cause”, “effect”, “singular”, “plural”, “can”, “must”, “will”, “time”, “space”, “free”, “necessary”, “probable”, “number”, “point”, “line”, “surface”, “substance”, “accident”, “subject”, “object”, “state”, “process”, and, as we have seen, “thing”.

Mental categories, as we call the results of categorization, are also very often designated in conjunction with the results of other operations, of differentiation or figuration, or other categorizations. “Singular” and “plural”, for example, certainly occur more frequently as categorizations of other things than as isolated categories.

An example will help us to see how a category is constituted, and so how it can be analysed. Let us take the very common categorizations of “singular” and “plural”.

What a gun produces when it fires can be regarded either as a singular, designated by the word “volley”, or as a plurality of “shots”. The difference may appear acoustically as well; but primarily it is a mental phenomenon; categorization has been carried out by the mind in two different ways. And it is not hard to discover the difference. In the case of the singular (the volley), while the shooting went on, there was initially a moment in which the ear heard the sound but the mind was detached, in a state, that is, of simple presence; subsequently there was a moment in which the mind participated, a moment in which the attention was focussed; and finally the mind reverted to a state of detachment, although the sound was still heard by the ear. Here we have, for the singular, a sequence constituted of the simple differentiatum of presence, which corresponds to non-focussed attention, followed by the combination of two differentiata, which corresponds to focussed attention, to the “something”, followed in turn by the simple differentiatum of presence, which corresponds to attention detached again. The analysis of the plural, when we speak of “shots”, on the other hand, displays a situation which seems in one respect the antithesis of this. First, that is, the mind participates in the noise, the noise is regarded as “something”; this is followed by a detachment of the mind, which is followed in turn by participation again.

Every differentiatum, figure, or category can be combined either with elements of its own kind, or with elements of another kind. The compound which results owes its originality both to the characteristics of its component elements, and to the particular order in which they are put together.

To constitute perception, the following operations are involved: (a) a succession of two differentiata; (b) the second of these is categorized “object”; (b') the differentiatum-object may receive a figure (by changes of place which are determined by the boundary line between the two differentiata).

Representation involves a different sequence: (a) a categorization “object”; (b) to this, differentiation is added; (b') the differentiatum-object may lastly receive a figure, by changes of place which this time are free, constructive.

This analysis in terms of operations, as can be seen, completely breaks with the tradition of the duplication of the object of perception; yet it maintains the sense of determinacy and obligatoriness which characterizes perception as opposed to representation, which latter we are aware of as free. In fact, in perception the object is always derived from a differentiatum which is one of a pair, even if subsequently the first of the two is discarded, serving merely as a foil; whereas in representation all the results of the relevant operations become part of the object, which, therefore, has all the freedom of an independent product, and is linked only to its own past history. This is also one of the reasons why representation seems less rich than perception; although it is always possible to make a comparison between the objects of perception and those of representation.

Other very common combinations are those by which we obtain physical things and psychical things. Physicality is the result of categorizing the objects of perception or representation as spatial, psychicality is the result of categorizing them as temporal.

The construction of differentiata, figures, and categories, alone or in combination, does not by itself amount to thinking.

Thought is produced by combining these items into characteristic temporal units; these are the correlations. Correlating consists in setting up a mental category of *relation* occupy-

ing the same interval of time as two other items constructed one after the other. In this temporal structure, the activity corresponding to the relational category and extending over the two moments functions as *correlator*; the activity which occupies the first moment, and then is replaced, functions as *first correlation*; and the activity which replaces it, and occupies the second moment, as *second correlatum*.

Here, then, we have the explanation of the difference, in the example we gave earlier, between “and”, “and”, “or”, etc., as a sequence of isolated words, and the same words in the sentence “and and or are relations”. In the sentence, expressing a train of thought, the second “and” is functioning as a correlator, while the first “and” and the “or” function as first and second correlatum respectively. It is not difficult to detect that the operation which functions as correlator, designated by the second “and”, goes on over twice as long a time as the operation designated by the first “and”, which functions as first correlatum.

“Flesh or fowl”, “blades of grass”, “trout in aspic” are examples of correlations; so are “Mario eats”, “bay horse”, “running fast”; but the latter are of a different type, in which the correlating activity consists in maintaining, as subject or as adjective, etc., the first correlatum while the operations constitutive of the second are being carried out. The pattern of durations characteristic of correlations is clearly recognizable when we examine how we understand an expression like “go and”, which, ending with the correlator suspended, leaves us waiting for a second correlatum with which to close the correlation.

Every correlation can be taken as an element, or correlandum, in a wider correlation. Thus in “John and Mary are a good pair”, “John and Mary” is used as first correlatum, a wider correlation whose second correlatum is “are a good pair”; a correlatum which is itself formed, not of one correlation, but of three. In this way we obtain correlational nets; and thought, in adult human beings, is carried on in nets containing dozens of correlations.

Let us now consider how *language* follows and designates the process of thought. In order to designate, or express, a correlation, which is the minimal unit of thought, at least five indications are required, and they are of two kinds. Three indications of the first kind designate the three specific items put in correlation. To designate the respective functions of these items, as correlator, first correlatum and second correlatum, we require only two indications of the second kind, because from any two the third can always be inferred.

All languages, whether isolating or inflected, can be shown to use these kinds of indication. Languages, however, differ in the ways in which they supply these indications; not merely in the choice of graphic or phonetic material (as for example “dog”, “cane”, and “Hund”), but also in the distribution of the indications. One language uses to a greater extent the phonetic or graphic material of the single words, another language uses rather the order in which the words succeed one another. Although both methods of indication are always employed, the correlational functions in particular may be prevalently determined either, as in Latin, by the form of the single words, or as in Chinese and to a large extent in English, by the word order.

In most cases we find the five indications contained in a sequence of two or three words; two, for example, in “John runs”, three in “travelling by train”. Occasionally a whole correlation or even a small correlational net may be designated by a single word; for example, in Italian, “rubarlo” (to steal it), “rubarglielo” (to steal it from him), and even “rubarmeglielo” (to steal it from him for me).

2. HOW LANGUAGE IS UNDERSTOOD BY MAN, AND HOW IT HAS
BEEN
DECIDED TO MAKE A MACHINE UNDERSTAND IT

“All studies on the problem of translation take it for granted that the translator has comprehended the language and thought of his text. But comprehension is not an easy thing . . .”

—ACHILLES
FANG.

2.1. *Man's understanding of language*

The problem of mechanical translation was approached, by the members of the Centro di Cibernetica, on the principles set forth in the first section [6]: that is, with the recognition that all languages are built on the basis of the thought which they accompany (only a parasitic language corresponds to some other both in its good points and in its bad), and that therefore the transition from one language to another must be made through the thought which is being expressed, just as we ourselves do, when in order to translate, we first comprehend the text. And also with the recognition that the transition from language to thought, and from thought to language, is achieved by means of the semantic connections we have isolated (at least five for each correlation: three to designate the specific things which are being correlated, and two to establish the positions of two of them in the construction of the correlation, that is, to designate their respective correlational functions).

But if any optimism is aroused by the discovery of this very simple correspondence between thought and language, it will soon be disappointed by the difficulties that arise in the further stages of the research. The indications needed to set up an unambiguous correspondence between language and thought, the indications which guarantee univocal comprehension of the text, are not always explicitly present either in the individual words or in their order; the graphic or phonetic form is, indeed, often insufficient; hence, among other things, when one tries to set down the established semantic conventions in rigid, usable rules, exceptions sprout in all directions. It becomes very clear that the missing indications are in some cases provided by an additional, integrating element derived from the clear representation we have of the things designated, and from a certain background of culture, of previous knowledge, more or less general or personal, but which is presupposed by the speaker or writer.

Let us give some examples of this situation. Here is a sentence from a recently-published detective story: “He left the book in the drawer open at page 22”. “Drawer” and “open” obey all the formal requirements permitting “open” to be applied as an adjective to “drawer”, and also the representational requirements, since we can very well think of a drawer as open or shut. But next there is talk of pages; we cannot represent to ourselves a drawer open at one page or another; whereas in representing the book we have already seen it with its pages, or at any rate we are quite ready to see it in this way. And so “open” is applied to “book” and not to “drawer”, contrary to the indications; contrary, that is, to the established conventions based on the form and order of the words. These conventions arose when people had already begun to use words, and therefore they can always be brushed aside by thought when the two seem to conflict. “So much the worse for grammar!”, said Voltaire.

Here is another example: “In a deck-chair, worn and depressed, there sat a young woman”. “Worn and depressed” could, according to its place and grammatical form, refer either to the deck-chair or to the young woman. But the listener will have no doubts; only the woman could be happy or depressed, not the deck-chair. This choice is made on the

basis of a general, previous knowledge, which constrains us to represent the situation in the only way possible according to our own past experience.

Cases of this sort are by no means exceptional. If they seem so, when, exceptionally, we stop to consider them, it is just because, especially in colloquial discourse, they are very frequent, so that we are accustomed to deal with them without even noticing the difficulty; and also because a person who learns to talk makes no conscious distinction between the two sources of indications, the formal and explicit on the one hand, and the implicit, derived from representation and culture, on the other.

Anyone who knows about the things involved will understand immediately that “that new car of Ford’s” and “that new car of Smith’s” mean two quite different things; in the first case the relation of product to producer, and in the second the relation of ownership. But both Ford and Smith are proper names, and the preposition is the same in each case; so we do not get the information about the relationship from these formal factors, but from what we already know about Ford and Smith; and someone not acquainted with the difference between the two names would not know how to understand the phrases. “To sing with grace”, “to sing with Callas”, “to sing with a microphone”, “to sing with the dawn”, designate four different situations, which are not indicated by the single preposition “with”, but by the known relationships between singing and microphones, singing and Callas, and so on.

In order, then, to set about linguistic analyses for MT, we must be prepared to build up a new grammar, with research going far beyond the normal classifications of words and the normal rules which suffice for the guidance of humans. It is an enormous enterprise, requiring immense patience; an enterprise which, until now, has never been carried out.

Further, to restrain the ambitions, or at least the impatience, of the builder of translating machines, another difficulty immediately appears, arising, as we mentioned in the previous lesson, from the impossibility of providing the machine, as yet, with a dynamic memory operating in the same way as the human memory. When we read a text we almost never strain our understanding of it by taking single words as the unit of translation. The indications given by single words serve to tell us what the bits are which are to be correlated, that is, that the sentence is about Colin and not about Lewis, about “quickly” and not about “slowly”, and so on. But before we recognize the correlational functions of the different *nominata* we nearly always wait until we have accumulated several words, three, four, even five, because these indications are often provided by the order of succession of the words, so that we need to see or hear a sentence.

Confronted with a single word, besides, there is only one thing we can be sure of, and that is that the function of the correlator can only be carried out by a category of relation, that is, a particular type of mental category. An *observatum*, “table”, “tree”, etc., could never function as a correlator. But the converse is not true; the mental category of relation may appear as a *correlatum*, as in our example “and and or are relations”, in “to argue for and against philosophy”, and so on. And further, the form of the word, according to normal grammatical categories, does not offer a wholly reliable indication of whether it can be a correlator or not, because although, in general, correlators do not have the form of a noun, the example “pressure times surface” shows that this too is possible.

The group of words and, therefore, the thought which corresponds to it, handed over to our dynamic memory, also has a very important function in that it leads us to anticipate, in some degree, what may follow, and thus to determine promptly the significations of the words which follow; similarly the dynamic memory is able to recall immediately the

previous stages of the thought and discourse, when this is necessary for the elimination of ambiguity in an expression.

All this, in a machine which, at present at least, must employ a memory composed of static records, is impossible.

The project of constructing a machine which would follow a discourse, carrying out all the operations which, in us, constitute understanding, not only the correlational operations between the words, but also the operations constitutive of the single contents, that is, differentiation, figuration, categorization and their combinations, though it is certainly theoretically possible (at the Centro di Cibernetica work is going on for the construction of a prototype which will observe and describe, carrying out all these operations; but for a very limited range of thought and using a very small vocabulary [4]), would involve our ceasing to expect that MT should produce practical results within a reasonable length of time, and would also involve setting aside, for the project and its realization, vast sums of money.

2.2. How much of the process of human comprehension of discourse should be retained in the design of a machine?

Faced with this difficulty, the impossibility of constructing, at present, a machine which should translate by repeating all our own operations, we nevertheless thought it desirable to continue our study of thought and language in man; both for the general theoretical value of these studies, and for their contribution, considerable in the past, and certain to increase in the future, to the project of the mechanization of intelligent activity; but in the meantime we also decided to adopt certain restrictive measures, some compromises for the machine's translation procedure. In this way, of course, we must not expect the machine to translate with all the correctness and elegance of a good human translator; but it will still be of very considerable use; and our consciousness of the compromise, ever before us, makes it possible in the future to supersede the limitations we have introduced, and keeps open the road towards the improvement of the translation.

Here I want to make a point which refers back to what I said at the beginning of the first lesson. If one decides to mechanize a dictionary, word by word, two words by two words, and so on, one is certain of obtaining a usable result in a relatively short time. The machine does not need to know at all what it is about; it may find words which its dictionary does not contain, and which it unconcernedly skips; in any case it keeps going. But if one makes the procedure of the machine dependent on classifications and rules, one must expect that, where these classifications and rules turn out to be incomplete, the machine will get stuck; and at the present stage of our analysis, it is inevitable that they should turn out to be incomplete. Under these conditions the machine can produce very little of use. Again, the number of classifications and rules quickly becomes so enormous that it could not be contained in the memory of any existing computer. But we are convinced that it is time the leap were made; the more so because procedures and machines for translation by, more or less, mechanized dictionary, already exist, and work with appreciable results.

In any case, after a thorough study of the operations carried out by a human translator, it will no longer be so easy to deceive oneself that a basic solution of the problem of mechanical translation can be obtained by mechanizing a normal bilingual dictionary or even a normal bilingual grammar. They have proved certainly to be efficient instruments for a man who is learning to translate, but they cannot be enough for a machine unless the machine is so constructed that it already thinks and speaks in at least one language.

Here, then, is our plan of campaign for MT, with the principal policy decisions we have taken.

(a) *The correlational "tabellone"*. The first decision concerns the unit of input. The machine takes as its unit of input the single word; the number of inputs then cannot exceed the number of single words in a language, and is thus restricted to a figure of the order of some hundred thousands.

For each word, the correlational possibilities of the thing which it designates are examined, allowing the word its maximum designatory scope.

For example, we say that the word "water" designates a correlatum, either first or second, of a correlation whose correlator is "and", "or", "with", etc.; but it cannot be the second correlatum of a correlation whose correlator is "between", because a plural is required for this position; we can say "water and" "and water", "water or", "or water", "water with", "with water", "water between" but not "between water".

To illustrate this example and those which follow, we will show next the graphic form in which we represent correlations; a rectangle divided horizontally into two parts, the upper part to contain the correlator and the lower, divided in turn vertically into two parts, to contain the two correlata, the first correlatum on the left and the second on the right.

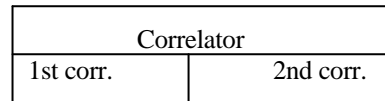

For "water", we have, then, the following possibilities:

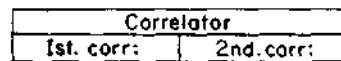
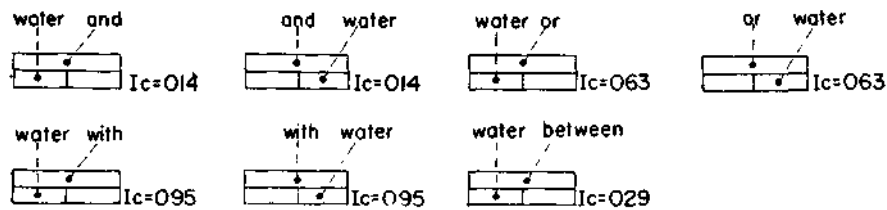

Naturally, this task of classifying words correlationally is carried out, as must always be the case, after the relevant criteria have been established. It is necessary here to fix the correlational position of the various designated things; but to do this it is necessary to establish a schema or pattern to which to refer them.

Various factors which emerged in a first, tentative phase of analysis, combined to suggest the schema and the criteria.

We found that the modalities of correlation, or correlators, the mental categories of relation, are relatively few in number even in the richest and most highly-developed trains of thought: we may say between 100 and 200 in all; and that these correlators, although not all identical in the thought of different peoples or at various times in a people's history, nevertheless show a strong resemblance among themselves, and seem to be among the most stable elements in the history of a language. Thus it was possible to decide that the correlational analysis of nominata should be carried out by enquiring into their correlational possibilities in relation to these correlators, picked out individually and set out each in a separate correlation, characterized then by its correlator. In this way we obtained corre-

lations distinguished by the presence in the upper box of a “by”, an “of”, a “for”, etc.:

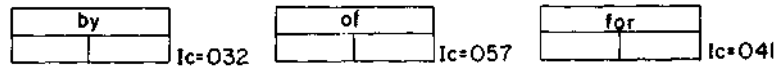

and in inflected languages, correlations distinguished by a genitive, a dative, etc., as well.

It is important, in connection with the correlators, not to confuse: (a) the relations designated by these correlators, which arise from the manner in which the flow of our operations is fragmented and reconnected; (b) the relations found to obtain between these fragments when they have become this or that specific content of thought; and lastly (c) the temporal relations which are involved in the constitution of the correlation itself.

For example, between “air” and “iron” we can find the relation [type (b)] of “rusting”, as soon as in thought, *qua* thought, “air” carries out the function of first correlatum in a correlation of subject-development, and “iron” has the function of second correlatum in a correlation of development-object [relations of type (a)] when, that is, we look at the things in a way conditioned by the question “What does air do to iron, with iron? How does air act on iron?”. But this relation “rusting”, which in any case is not of the mental but of the physical kind (a transformative relation), when it is formulated in a thought expressed by the sentence “Air rusts iron” or “The air rusts the iron”, does not appear as a correlator, but as a correlatum; second correlatum of the correlation subject-development whose first correlatum is “the air”, and first correlatum in the correlation development-object whose second correlatum is “the iron”.

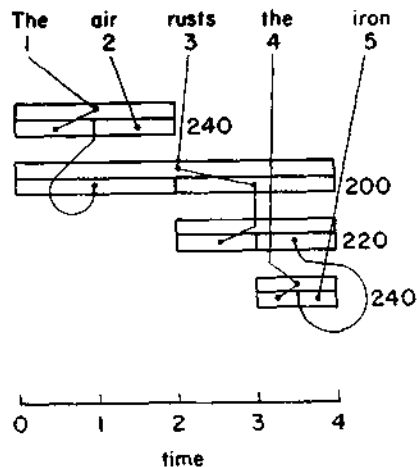

In this correlational net the four correlators which occur, all similar and of type (a), have nothing to do with the relation of “rusting”, but consist, each one, of a mental category of relation which is that of *maintainment*, of addition, which we shall discuss more fully in a moment. The relations of type (c), that is, the durations of presence of the various correlanda, can be read off from the graphic representation we have adopted for the correlation, if it is interpreted like a musical staff; on the net shown here, the times of presence have been added along the bottom of the diagram. The same situation obtains, of course, with relations like those expressed by “John beats William”, “The whole contains the part”, etc.

This distinction also accounts for the fact that relations of type (*a*), the modalities of construction, are fairly limited in number, are constant, and are found to be more or less the same among different peoples; that relations of type (*c*) are actually only three in number, and completely the same for every train of thought; whereas relations of type (*b*) are much more numerous, running into thousands, differ widely according to the cultural heritage of the different people concerned and, in the course of the last 2000 years, have shown a progressive increase in number.

Our decision to take the correlators as point of reference, and to treat each correlator as an individual, would result in a "tabellone", or master-chart, containing, one after the other, for example in alphabetical order, all the correlations individuated by these correlators, and nothing else.

But this narrow and rigorous solution did not turn out to be the most suitable; chiefly because the most frequently-recurrent of all the modalities of construction is the one which consists in the simple addition of one operational fragment to another, and which is made by maintaining the first correlatum and superimposing on it the second; and this modality almost always lacks a designation of its own in terms of a correlator; instead, it is indicated in the most economical way, simply by the designation of the two correlata, and is then immediately divided into many sub-types, according to certain ways of grouping the things which represent the terms of the addition to be carried out in the correlation.

We find here, for example, on the one hand things and on the other hand the story which follows them, the story of which they are the protagonists, the subjects; these things then are first correlatum, and their story is second correlatum, of the correlation of addition; or again, on the one hand are the things, and on the other, the story which precedes them, the story which they receive, by which they are affected, of which they are the objects; then the story is first correlatum, and they are second correlatum, of the correlation of addition. We find things and their aspects, with the possibility of moving from the whole to the part, that is, to the aspect, or vice versa, so that the positions of the correlata are invertible. And so on.

Initially, all these subtypes were presented under the one correlation of addition; but later it proved to be more convenient to lay out the tabellone with these distinctions already made; because in some cases the words which pertain to one or another of them can be treated individually or almost so, that is, in very small groups, and because we wished to avoid overcrowding a single correlation which would then immediately have to be distinguished, for one reason, because they have to be reclassified differently for re-use as correlanda of wider correlations.

A chart was thus obtained in which the correlations are characterized in some cases by their different correlators, taken as individuals, and in others by their correlata, taken as classes or collections.

Another modification of the principle of constructing the tabellone with correlators alone was introduced when we added German to the other languages, Russian, English and Italian, under analysis. In German many words occur which combine the designations of a specific correlator and of a first correlatum in the form of a pronoun, such as "deswegen", "damit", "davon", "danach", "woran", "dadurch". In other languages also, words are found which designate in this way; but they are not so numerous as to have suggested our treating them as a separate group, as has been decided now.

To make clear the function of these enriched correlators, we must recall the function of the relative pronouns and of the full stop between sentences. Clearly, the correlational

unity, the net of correlations, that is, the unity of thought, is not interrupted by a full stop; if it were, instead of a discourse of several sentences, we would have several separate discourses, separate thoughts. But often it is left to the reader to make the relation which connects the two sentences. Thus, for example, when we read "Mario tornò a casa. La moglie lo attendeva" (literally: "Mario went home. The wife was waiting for him"), it is obviously we ourselves who connect the two statements, by a relation of appurtenance, which in English and many other languages has to be expressed in such a sentence by the possessive pronoun: "his wife"; or at any rate by a relation of kinship.

As we shall see again later, when we come to discuss the comma, it is not possible for thought to be carried on indefinitely by links of this kind, which can have as correlata dozens of correlations. The human mind, then, works by stops, or pauses, after each of which we take up again all that went before in the form of a summarized record. In other words, not only the thing designated by a single word, or by a phrase, but sometimes what is designated by an entire chapter is taken up again in this way. It follows that languages will have designations which can carry out this function; which indicate at the same time the retrieval, more or less compressed, of what went before, and the relation by which the train of thought is to go forward, widening the correlational net. It follows also that some designations will be found which are only used when this happens with correlational units containing at least a whole sentence; and hence that the piece which comes before and is retrieved in summarized form will be marked off, gathered together, before the retrieval, by a punctuation mark: a comma, a semicolon, or even a full stop.

These correlators, then, which are combined with a relative pronoun in a single word, are also listed in the tabellone, and form a group of their own.

Altogether, as we have said, the tabellone, although it was suggested by a precise interpretation of thought, is now designed instrumentally, as a linguistic-correlational chart in which certain fixed word-positions serve as reference for all other words. This concession to practical considerations also means, of course, that the different charts, in accordance with the variations of individual languages, are less alike than they would be had they been constructed with strict regard to thought alone. We therefore decided to make certain alterations to each of them which would ensure a reasonable degree of correspondence at least in the field of the five languages on which we are working: Russian, English, Italian, German and Latin.

A further stage which we envisage is the compilation of a single unified tabellone; not, perhaps, universal, but sufficiently articulated to contain all the languages with which we are concerned.

At present (Spring 1962) the "tabelloni" of the five languages have been compiled.

Every word, as we have said, is classified by the correlational possibilities of what it designates, in relation to the tabellone. Since the word is taken as isolated unit of designation, it must receive all its correlational possibilities. These possibilities, in the case of some words, especially in languages which are not inflected or only slightly inflected, such as English, are very numerous; for certain words nearly all the possibilities are open. The word "water", for instance, will occupy more than 160 positions.

But these correlational possibilities are rapidly reduced when the word is part of an actual sentence, as an effect of the order of succession of the words; as soon as the word is followed by another, or even just because it is the first word in a sentence, after a full stop, its possibilities are restricted very considerably. For example, the word "John", will occupy, among many other positions, that of first correlatum of IC 014 ("and"), of IC 063 ("or,")

and of IC 200 (subject+development). But if it is followed by the word “runs”, for instance, it will lose the first two possibilities and retain the third. And if it figures as the first word after a full stop, this is enough to exclude the possibility of its occupying the place of second correlatum, for example, in the correlations of “and”, “or”, “but”, etc.

The situation is quite analogous in the game of poker. Any card, in itself, can enter into all the eight possible poker combinations (pair, two pairs, threes, full house, straight, flush, fours, straight flush); but as soon as we have a second card, these are immediately restricted. For example, if a ten is followed by another ten, a straight and a flush are already excluded.

The linguist, then, who examines one by one all the words of the dictionary, in their basic forms and all their inflections, writes for each form a card which contains its correlational, or tabular, possibilities. But at the same time he has to write the rules which determine—according to the succession of the words, that is, taking account of their respective positions in the order in which they can appear in the discourse—which of these possible combinations can be made and which must be excluded.

At least two rules of this sort are general in their application. The first states that the two correlata, first and second, in order to constitute together a correlation, must belong to the *same* correlation; in other words, they must carry the same number (every correlation has an index number or Index of Correlation, IC, assigned to it, as shown in the tabellone). The second rule states that the two correlata should be complementary, that they must not both occupy the same place in the correlation. In other words, if the IC is the same in both cases, and if the numbers 1 and 2, preceded by an oblique stroke, indicate the first and second correlata respectively, then one word must have the IC followed by /1 and the other word must have the same IC followed by /2.

For example, although “Lewis” appears classified as both first and second correlatum of the correlation IC 095 (with)



and of the correlation IC 041 (for)



once it appears preceded by the words “John with”, it can only occupy the place of second correlatum in the correlation IC 095.

As well as these extremely general rules, which are valid for all languages (because they derive from the actual criterion used for analysis of languages with regard to thought), there are other rules, still general but associated with the individual languages; for example, those well known under the name of rules of agreement, which all languages, or almost all, have in greater or less degree. These are the rules which prescribe, for example, that in English a subject in the third person singular must have a verb correspondingly in the third person singular. These rules, of course, are arrived at by examining the correlations individually.

These rules therefore require other classifications, which in most cases depend on the particular characteristics of the individual languages. For example, Italian and French require agreement in number and gender between substantives and adjectives (correlations IC 240 and IC 260), whereas English makes no such stipulation, because adjectives do not change their form to indicate either number or gender.

Besides rules of agreement, there are rules concerning the order of succession of the words in the discourse. For example, in English the article, definite or indefinite, never combines with what precedes it but only with what follows. Rules of this kind, however, in many cases are extremely elastic; they are subject, that is, to numerous exceptions, when once they have been set up on a basis of the majority of cases.

The plan of campaign, then, for bringing a language under control, proceeds by successive stages. When we have drawn up the *tabelloni*, or charts of correlational references, we begin to set up the rules which limit the correlational possibilities of each single word; but only within the limits of a correlational classification of the word and of the place, in the order of succession of the words, which it occupies. But this is not the end of the first stage of the analysis, because the correlations must themselves be analysed and classified with a view to the possibilities of their figuring in turn as *correlanda*, of carrying out a correlational function as units in wider correlations, when we pass from the single correlation to the correlational net [7].

This time, of course, the classification is no longer the work of the person who prepares the word-matrices, but of the machine itself, and it is carried out according to rules which are furnished to the machine and applied by the machine, making use of the earlier classifications of the words and also in some cases of others. For example, in the case of the correlation IC 057 (“of”), the complete correlation will have assigned to it, by the machine, all the classifications already belonging to the first correlatum. In the case of the correlation IC 014 (“and”), the whole correlation gets reclassified as a plural, not only when one of the two correlata already contains a plural, but also when both are singular, provided that they are not aspects of things, adjectives (correlations IC 240 and IC 260); but here again exception must be made of the ordinal adjectives (“first and second” is reclassified as a plural), etc. To return our example of the correlator “between2 (IC 029), which, as we said requires a plural as second correlatum, this new classification allows the machine to accept as second correlatum a complete correlation, such as, for instance, “Margaret and Sally”.

At this point we regard the first stage of the machine’s understanding of a text as complete. But, as has already been mentioned, there is a great deal more to be done. With the analyses and classifications made so far, there remain two sources of error, because on the one hand we have set up rigid, but partly arbitrary rules about the significance of the position of the word in the order of succession in the sentence, thus obtaining correlational nets which may be wrong, while on the other hand we have set up broader rules which often yield not one correlational net, but a considerable number of alternatives, among which the correct one certainly figures but without a criterion to distinguish it from the incorrect. This will happen particularly in a language in which the order of the words is of meagre correlational significance, that is, lacking indications regarding the net which is to be constructed; this is the case in Italian, for example, which inherited from Latin some of its freedom in the placing of words, but has lost the Latin case-endings, and contains many words which bear no indication of either number or gender (words like “rosa” and “viola”, for example, when they are used as adjectives).

An expression which illustrates this situation is “comprare un dizionario di francese

tascabile" ("to buy a pocket French dictionary"). In Italian, no rule of agreement excludes the possibility that "tascabile" should be taken as second correlatum of the correlation IC 260 with "francese" as first correlatum, so that the sentence would mean "to buy a dictionary of pocket French". But this would be wrong, and the error would persist if we set up as a rule that the words which designate the aspects of things, namely, the adjectives, must occur in a position adjacent to the words which designate the things, namely, the substantives. If we do not set up this rule, and ask the machine to make all the possible combinations within the sentence, there will be no less than six combinations for the various possibilities of "tascabile" alone.

(b) *The analysis of the correlanda.* The second stage, then, involves a much subtler analysis than the one carried out so far in relation to the tabellone; we now need an analysis of what the words designate. The need for this further analysis can be demonstrated either by examples of sentences such as we have already given, which require it for their interpretation, or by reference to the fact that a man, in expressing himself and in understanding, does not work by referring to classes, or even to examples, whether of *nominata* or of words. These groupings are only carried out by someone who specifically wants to group things, and produces in this way, at one level or another, scientific knowledge. A child, for instance, learns the use of the words "the" and "a", without needing to know that they are "articles" or "adjectives of a particular kind", or that they represent the two elements of a particular collection because they designate two different ways of considering things, in one aspect opposed, but in another aspect similar to each other. As children we learn our language, while we carry out the operations designated by each single word, and by the sequence of the words; not only the operations of correlating, but also the operations that constitute each correlandum. And this, as we have said, imparts to us, as a direct, dynamic representation, what situations are possible and what situations are impossible. But, as we have also said, there is more in this dynamic operating: our memory retains previous thoughts, in the form of background knowledge, of general culture, so that to a large extent we already know what things can do and in what relations they may stand to one another; and with this knowledge, when we meet one thing we anticipate certain others. If, for example, we read the phrase "Colin bought books from", we are already expecting someone, a bookseller, a friend, etc., who could have sold them to him; at any rate a person or an organization, because we know that only people buy and sell things, that man is the only economic animal.

But the machine which has to translate one language into another is not a machine which thinks and talks in a language of its own, and it has not collected a body of knowledge of this sort. The new analysis must supply the machine with what it needs of this knowledge.

Even without considering for the moment what is needed from this analysis in translating from one particular language into another particular language, which will be discussed in our third lesson, the new analysis has to provide the machine with information which will enable it to overcome difficulties of at least five distinct types.

First of all there is the problem of the polysemanticity of the individual words. It often happens, either fortuitously or for some historically ascertainable reason, that one word designates not one single thing, but two or more. For example, the Italian word "piano" means either the musical instrument, or a plane surface, or it is an adverb meaning "gently" or "slowly". The English word "mole" means either a small animal, or a structure associated with a harbour, or a mark on the skin; and so on. Since these ambiguities rarely correspond

in two or more languages, it is clear that before we can choose the word in the output language to translate one of the meanings rather than another, it is necessary to ascertain what meaning the word actually has in the context where we find it. But it may be necessary to know this even at an earlier stage, before we can make the correlational net corresponding to the understanding of an expression.

Consider, for example, the sentence “work on this problem is proceeding”, where, in the phrase, “work on this problem” taken alone, “work” may have the meaning either of an imperative verb or of a noun, giving two different nets:

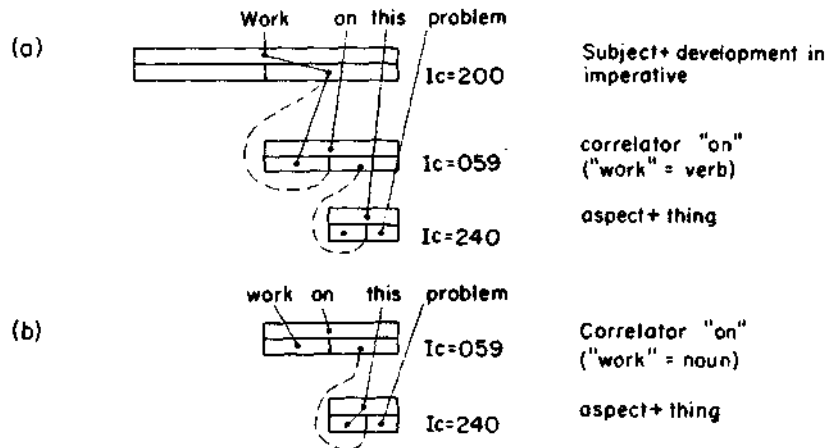

But in the context, that is, when followed by the development “is proceeding”, the ambiguity disappears, because net (b) can be reclassified as a possible first correlatum of the correlation subject+development, with “is proceeding” as second correlatum, whereas no way can be found of correlating net (a) with the development “is proceeding”. In the complete sentence, therefore, net (b) is accepted.

As we have said and illustrated, the greatest source of polysemanticity lies in the significance of the place of a word, the place of a word in a succession of words is always relevant to the thought which is to accompany the expression, but often it is by no means univocal in designating the correlata which are to constitute one correlation or another in a correlational net.

Let us pause for a moment to illustrate the statement that the place of the word in the sentence is always significant. Consider, for example, the two expressions:

“He drinks water”, and

“Water he drinks”.

There is no possibility in either case that in the correlational net “he” will not figure as first correlatum of a correlation IC 200 (subject+development) whose second correlatum is “drinks”, or that “water” will not figure as second correlatum of a correlation IC 220 (development+object), whose first correlatum is “drinks”. But when we read or hear the two phrases, is the thought which is set up by them really the same in both cases? We can easily recognize that in order for “water” to become the object of “drinks” it must follow it in our minds; but we can also see that in order for this to happen in the second example, “Water he drinks”, “water” must be *maintained in* our thought in order to re-enter after the verb; in thought, that is, as an effective temporal structure, we cannot move

backwards (whereas we can very well move backwards or forwards *with* the mind, when we construct the mental category of “past”, of “before”, and of “future”, of “after”) and, therefore, once we have read beyond the word “water” and have not found a possible correlation for its nominatum and the nominatum of “he”, we cannot simply return to the nominatum of “water” in order to correlate it, across “he”, with what might follow. However, since thought is always constituted by correlations made up of correlata in a given order, it is clear that the second example requires a repetition of the nominatum of “water” which is not required in the first example. This repetition is provided for by a new correlation, the correlation of *maintainment*.

The two correlational nets corresponding to the two phrases show the difference in structure clearly:

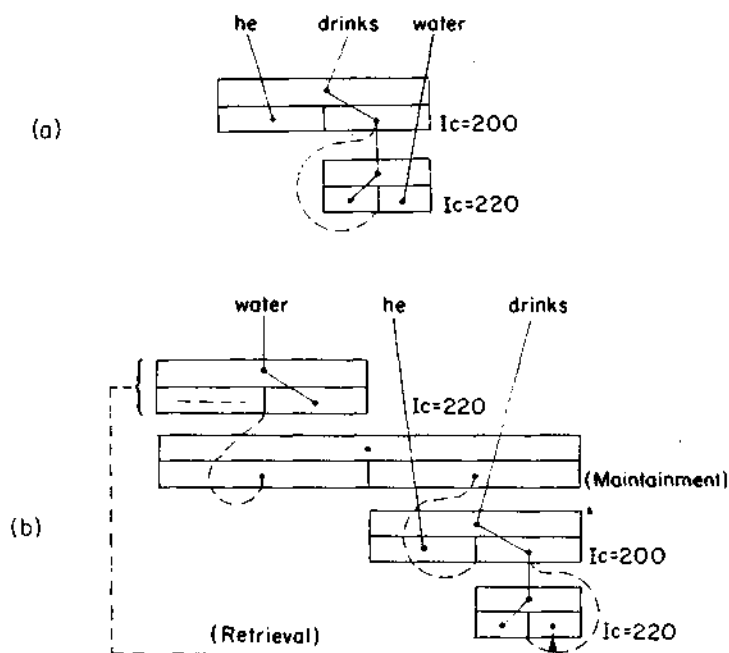

But now let us consider what happens if the two phrases are:

“He drinks water”, and

“He drinks, water”.

Again, there is no possibility in either case that in the correlational net “he” will not figure as first correlatum of a correlation IC 200 (subject+development), and so on. But again, the thought is not identical in the two examples. The correlation IC 220, development+object, that is, “drinks water”, has in the second case been interrupted, divided by the comma (this also has the result that “water” is unexpected, because “he drinks” without an object almost always implies that he drinks alcohol); and now, in order that “water”, isolated as it is, should enter as second correlatum of the correlation IC 220, whose first correlatum is “drinks”, “drinks” has to be picked up again, or *retrieved*; we retrieve the piece which was held up by the comma.

Thus, although the correlata constitutive of the thought are again the same in both cases, the thought in the second example is more complex, because of the repetition which does not occur in the first example, and a new correlation, by which this repetition is made, the correlation of retrieval.

The two correlational nets, corresponding to the two phrases, show the difference:

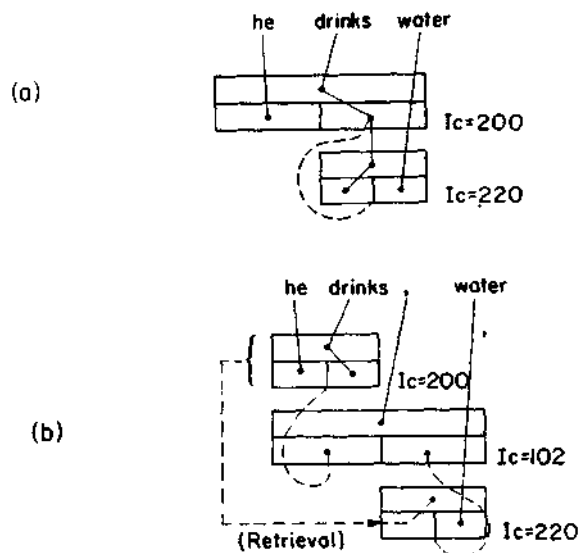

But it is not in such cases as these that the order of the words gives rise to difficulties. The difficulties arise when there is no indication, in the form of the word or in the position it occupies, which tells us how to arrange the various designated things in correlational units corresponding to the thought of the writer. Even a sequence of three correlata, where the correlator is an "of", or an "and", occurring twice, will produce this situation. Should the last correlatum be connected to the first two which are already a correlational unit, or should the first be connected to the other two? "(A of B) of C", or "A of (B of C)"? In a faulty phrase like "a house for a large family with garden", as far as the form of the words is concerned, "with garden" could complete the correlation opened by "a house", or by "a large family", and the proximity of "a large family" would lead one, as is more usual, to correlate the adjacent pieces: "a large family with garden". But we, when we read the sentence, nevertheless represent to ourselves the garden together with the house, not together with the family, and so, contrary to the usual way of taking the meaning of the order of the words, we jump over "for a large family" and constitute the correlation "a house with garden".

Situations of this kind arising from the ambiguous reference of a pronoun, where one has to decide to which of the preceding correlata the pronoun refers, are extremely common; especially with relative pronouns, which, in English, French, Italian, etc., can occur without any indication of number or gender. For example, in the sentence "he bought a violin and a mouth-organ, which he immediately put into his pocket", and "he bought a cigarette-holder and a cigarette-case, which he immediately put into his pocket", there is nothing in the classifications dealt with in traditional grammar, nor in those provided, at this stage, for the correlational tabellone, which will supply the information that in the first case the

“which” refers only to the mouth-organ, whereas in the second case the “which” refers to the cigarette-case *and* to the cigarette-holder. The decision that this is the case is derived, even if unconsciously, from the way in which we represent the two situations; that is, from what we know of the possible relations between, on the one hand, the violin, the mouth-organ, and a pocket, and on the other hand the cigarette-holder, the cigarette-case, and a pocket.

It is necessary, therefore, to go on to a second stage of analysis and classification, in which, independently of the words by which they are designated, and independently of the positions of the words, we establish what the designated things contain, what elements constitute them, and feed this information to the machine, in order to reconstruct the relations between them, possible and impossible. The results of these analyses certainly will not fully replace the richness of our own representations; but they will make it possible to eliminate at least some of the incorrect alternatives in the comprehension of a text which arise from the ambiguous significance of the positions of the words.

For these reasons, as we said, we regarded the analyses and classifications that belong to the correlational tabellone as constituting only a first stage. The next step will have to deal with distinctions applied to *nominata* themselves, which would not display any differences in respect merely of the way in which they are designated; that is, whose nominating words are formally classified as the same. An example will show what I mean. “Apples” and “hours” will receive, in the tabellone, the same correlational possibilities, and in grammar the two words are treated identically, as nouns in the plural. Thus, for the tabellone, and for the grammar, “mangiare tre mele” (to eat three apples) and “mangiare tre ore” (which in colloquial English could be: to eat three hours) are not distinct. But we regard “apples” and “hours” as two very different things, the first edible, but the second certainly not, unless we understand “eat” in a wholly metaphorical sense. New classifications are indicated by this; “apple” is an *observatum*, physical, with a form, and is a specimen of the class of edible things; “hour” is a measure of time, in which are combined two mental categories and the reference to a physical process. It is necessary to keep apart, then, on the one hand “apple”, with “pear”, “orange” and other fruit, and on the other hand measures of time; or at least, even if we cannot yet do this, to keep apart observable things from mental categories.

It may seem that these classifications are useful rather for translation than for passing from the input text to the correlational net, the designated thought; because it may happen that in one language (to use the same example again), the object of an activity and the duration of an activity will be indicated in formally different ways; this is the case in correct English. But in fact they have proved necessary, also, for the text to be understood by the machine as a single and correct net. For example, if the expression were: “chiacchierò e mangiò tre ore”, which in colloquial English could be: “he talked and ate three hours”, “tre ore” would require as first correlatum the whole expression “chiacchierò e mangiò”; but if it were “chiacchierò e mangiò tre mele”, “he talked and ate three apples”, then “chiacchierò” will take as second correlatum (after the correlator “e”) the complete correlation “mangiò tre mele”.

Another difficulty which has to be dealt with by these new analyses and classifications arises from the fact that many things in a discourse are left to be understood, because they are so obvious to a person whose thought is interwoven with dynamic experience and background knowledge that they can very well be left out of the text; but in the machine these omissions make an effective lacuna. Here are some examples: “You know Latin,

but not I"; "Mary wore blue, Sally black". In our classification, in the definition of persons we must include the possibility of knowledge, and in the definition of knowledge we must include knowledge of languages; in the definition of persons we must make reference to clothes and in the definition of clothes we must make reference to colours; and so on; one then has to examine both the correlational relations, and the relations based on content, which have given rise to a preceding situation; only in this way can a subsequent situation which lacks certain items be completed by taking these items from the preceding situation.

The work of analysis and classification, then, is based on the correlational tabellone and proceeds by progressively subdividing everything which is not already treated individually in the tabellone; that is, by subdividing the correlata.

For example, in the English tabellone we find the correlata of "about" and of "by" subdivided into classes, or rather collections, since a language is a finite collection of words even if it can expand. The correlata of "about" will have subclasses, such as mental things and activities ("to think"; "mathematics"), accompanied more or less closely by discourse ("to speak"; "a book") or by feelings ("to cry"; "victory") and on the other hand non-mental things and activities ("to walk"; "house"). The correlata of "by" will be divided into subclasses such as transitive developments and intransitive developments, and among the latter, developments involving spatial relations, further subdivided into developments of state and developments of motion, for the first correlatum; and, for the second, subclasses of possible instruments, and of possible localizations. In the correlation IC 240, for the aspects of things, we immediately find the articles separated off as one sub-class, because they represent a very particular manner of considering a thing in two opposite ways; either in isolation, when we are interested in the thing's continuity in a history (definite article), or together with other things in the single present moment (indefinite article).

This work, of course, can only be regarded as complete when, as in the human mind, every nominatum has been treated as an individual, as unique, as exactly what it is; but already each step in this direction is an advance in the correct comprehension of the text and, therefore, also a reduction in the number of alternative correlational nets we can make to correspond to it.

Given that after the first stage we have to speak of a certain number of other stages in analysis and classification, it is clear that these divisions are discretionary, just as, to a certain extent, even the division we made between the first and second tabellone was the result of a compromise. In our programme we expect to regard a further tabellone as complete, adequate, only when its classes are at least three times as many as those of the previous tabellone.

A diagrammatic representation of these successive steps, from the first correlational tabellone in which only the correlators are taken individually, to the last stage in which the correlata are also treated as individuals, might look like this:

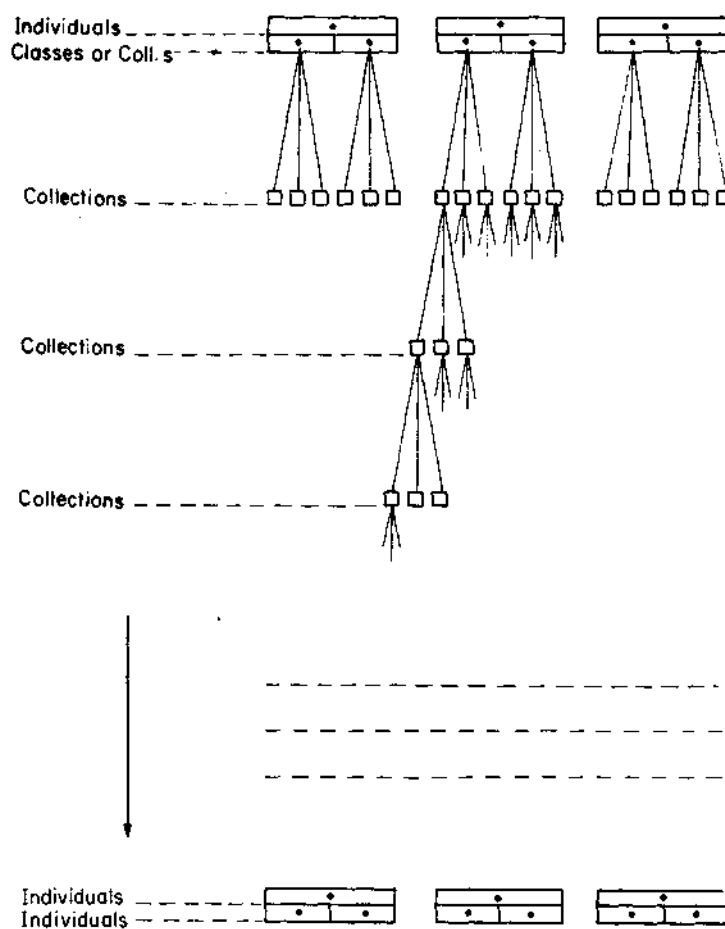

It is clear that the sequence of the tabelloni is a contingent and practical problem, depending on the degree of accuracy we wish to achieve in the comprehension of the text, and therefore also in its translation, and on the other hand on the amount of progress made, the degree of subtlety achieved in the analyses.

Information, essential for the machine, concerning the relations between certain specific things, and concerning the things between which certain specific relations hold, may be introduced into the machine's operating in two different ways; either by making a pre-determined list, or by arranging for the machine to search them out for itself, referring directly to the analyses and classifications of the things, as soon as it encounters one of them.

We will illustrate the two possibilities by way of our earlier example about the gentleman who "bought a violin and a mouth-organ which he immediately put into his pocket". We know quite well that the possibility of being put into a person's pocket holds good only for the mouth-organ and not for the violin, because of the relative sizes of a normal jacket or overcoat pocket, a violin, and a mouth-organ. A relation of container-contained can certainly be set up between the pocket and the mouth-organ, and of "non (container-

contained)” between the pocket and the violin; and we can make the developments “put into”, “put in”, “enter”, etc., dependent on the relation of container-contained; and we can provide the machine with the ready-made conclusions about this, together with the premises. But, on the other hand, we may allow the machine to draw the conclusions for itself, at any rate in part, and restrict ourselves to classifying in terms of their absolute size all the things which have size, that is, all spatially extended things. This second alternative is certainly the more economical.

The need to know what these relations are is fundamental for the translation (or even the summarizing) of a text [8].

Up to this point the analyses and classifications have been made with a view to the comprehension of a text by a machine. But more than this is required if the text is to be translated into a different language; or rather, this would be enough only if the comprehension of the text were carried out in the way in which we ourselves do it, that is, not on a basis of classifications but by effectively carrying out the operations constitutive of the thought and its contents corresponding to the text. At present, it is to be remembered, in these analyses and classifications we are concerned to establish no more than is indispensable in order to avoid a situation in which the machine constructs, in correspondence to a given text, either a number of alternative correlational nets together with the correct one, or a correlational net which is the wrong one.

This necessity is constantly confirmed by examples which we come across in every kind of discourse. It arises chiefly in cases where different languages use different criteria in distributing the two sources of indications; the explicit indications, furnished by the words themselves, and the implicit, derived from the experience and knowledge of the person who is using the language.

A common case of this occurs when one language designates a certain particularity only by means of the subject or object of an activity, and not by the word corresponding to the activity itself, whereas other languages designate it both in the subject and in the activity, or both in the activity and the object (that is, use several verbs to cover the same ground as one verb in the first language); or when one language designates the specific nature of a relation by designating its terms only, while another provides the specification in the designation of the relation itself [9].

A characteristic example of the first of these cases is provided by the Russian verb “SEST-J”, which signifies, quite without ambiguity, that the distance between two points decreases. This distance decreases, for example, when a man sits down, when an animal crouches, when an aeroplane lands, when a bird alights, when a piece of timber gives way, or sags, when a ship sinks, when a garment shrinks, and so on. The subject or the object of this action having been specified, we in English and in Italian nevertheless specify what is happening by means of the choice of the verb as well; so that it would be absurd to say of a ship that it sits down, of a bird that it sags, and so on, even though this may sometimes happen as a metaphorical use of the words, as for example when in Italian one says of an unsuccessful soufflé that it has “sat down” (“si è seduto”). Consequently, on meeting a Russian sentence in which a single verb corresponds to all these variations of subjects and objects, the translator must choose between the seven or eight verbs which English or Italian needs to cover the same range. But this is only possible if the relation between the subjects and objects, with their activities, has been isolated and specified.

A characteristic example of the second type is provided by the Italian verb “pagare”, to pay. It is used in exactly the same way to say “pagare Mario”, to pay Mario, where Mario

is the recipient of the money; “pagare l’automobile”, to pay for the car, where the car is the object bought; and “pagare un milione”, to pay a million lire, where the million is the price paid. But a language which distinguishes these three different relations by three different forms of complement (English, as we see, uses two) could only be properly used in this situation, if the person translating has understood which relation is involved, on the basis of the sort of object mentioned.

The use of this of analysis and classification is continuous, again, if translation is going on between an input language which does not use articles, such as Russian or Latin, and an output language which does, such as English or Italian. As we have already mentioned, the articles are chiefly used to designate the way in which we arrive at given things in our thought; whether we are meeting them for the first time, as is indicated by the indefinite article, or whether we have met them before, as indicated by the definite article. For example, when someone is shown a room for the first time, he will, in describing it, speak of “a” table, “a” reading-lamp, etc. But, if he has to mention them a second time, for any reason, they will have become “the” table, “the” reading-lamp. In order for this to happen it is not necessary for the things to have been previously mentioned explicitly it is enough if we have already come across, in the train of thought, some other thing to which they are closely linked by some relation. For example, together with “jacket” we bring in at the same time the collar, the breast-pocket, the inside pocket and so on; so that we will say “I bought a second-hand jacket, but I had to have *the* breast-pocket re-made” [10].

(c) *The notional sphere and the constellations.* Until we can hand over to the machine the task of isolating the relations between all the various possible contents of thought, with their fragmentation into atomic operations, which at least in part will be able to stand for our original contents of thought, we have arranged to integrate the initial correlational tabellone and the other successive tabelloni by means of (a) a *notional sphere* and (b) an analysis in terms of *constellations*, at present centred on the developments (i.e. the verbs), but intended to be enlarged to include things and their aspects. At present about 300 developments have been analysed.

In the notional sphere, the various designated things, listed in the dictionary with which the machine is equipped, are taken into consideration individually, and the relations which usually hold between them are specified.

In this connection, it must not be supposed that these basic relations are very numerous; they are not more than a few hundred. An investigation to isolate them has already been carried out for the commonest things, and the list which we give here shows which they are; while a few exemplificatory tables illustrate directly what we feed to the machine to replace our own knowledge as ordinary people.

Notional sphere. List of relations

<i>Number of relation</i>		<i>Type of relation</i>
1	element	collection
2	member	class
3	species	genus
4	part	whole

<i>Number of relation</i>		<i>Type of relation</i>
5	component	compound
6	constitutive characteristic	thing characterized
7	subsequent characteristic	thing characterized
8	thing produced	thing which produces it
9	thing produced	place of production
10	thing contained	container
11	thing supported	support
12	thing pulled	thing which pulls
13	thing directed or guided	thing which directs or guides
14	provenient thing	provenience
15	preceding thing	thing which follows
16	thing covered or closed	thing which covers or closes
17	decorated thing	decoration
18	thing pushed	thing which pushes
19	principal thing	accessory
20	means of protection	thing from which sth. is protected
21	material	form
22	material	physical state
23	preceding stage of genetic development	following stage of genetic development
24	ascending kinship	descending kinship
25		collateral kinship
26		historical association
27		contiguity
28		opposition
29		economic relation
30		semantic relation
31	subject	activity
32	subject	object of activity
33	subject	result of activity
34	subject	material of activity
35	subject	instrument of activity
36	subject	usual place of activity
37	subject	usual time of activity
38	activity	object
39	activity	result
40	activity	material
41	activity	instrument
42	activity	its usual place
43	activity	its usual time
44	result of activity	material of the same activity
45	result of activity	instrument of the same activity
46	object of activity	result of the same activity

<i>Number of relation</i>	<i>Type of relation</i>	
47	object of activity	material of the same activity
48	object of activity	instrument of the same activity
49	object	its usual place
50	object	its usual time
51	material of an activity	instrument of the same activity
52		complementary instruments
53		complementary objects
54	thing	material
55	function	organ
56	thing	aspect

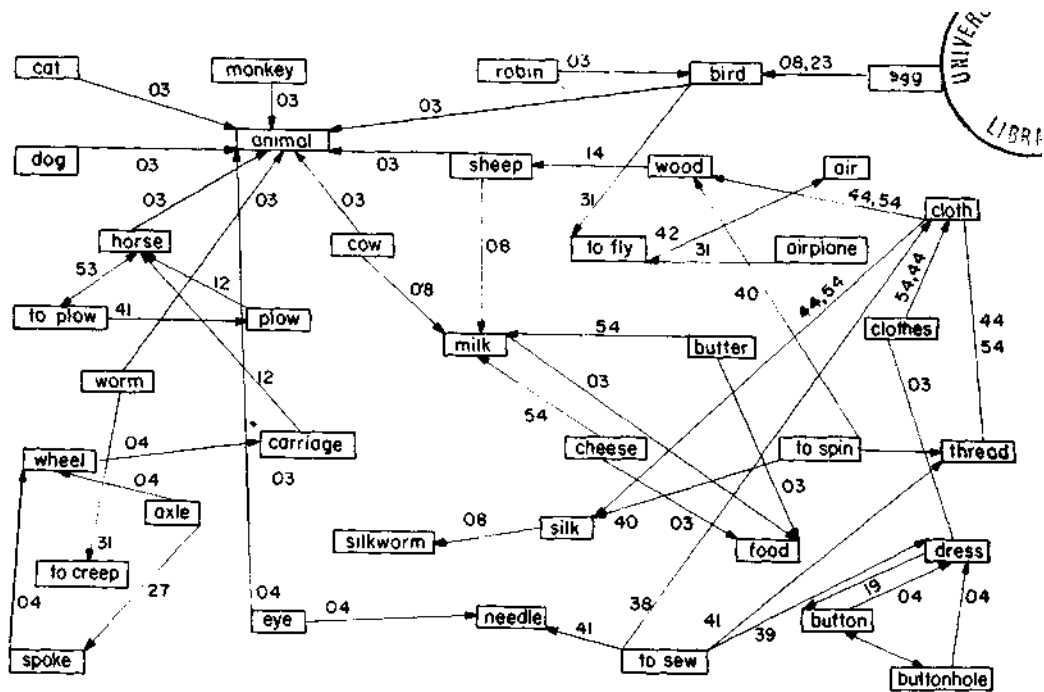

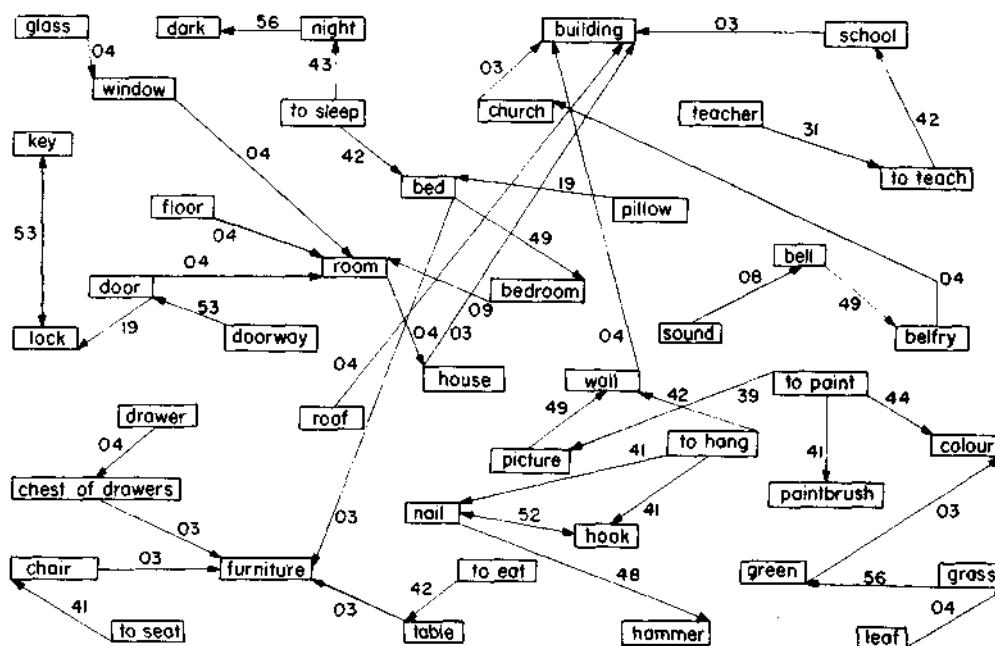

Note to the notional sphere tables

The preceding tables demonstrate two sections of a Notional Sphere studied for a dictionary of about 500 English head-words.

The lines linking the individual boxes show that at least one relation has been identified between the things contained in the boxes; the numbers on each line indicate the particular type of relation that has been individuated (see List of Relations, pp. 83 - 85); the arrow indicates the direction of their relation. For example:

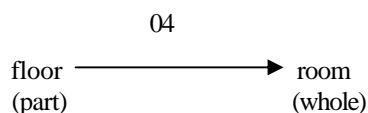

Note that not all the possible relations between the things have been explicitly identified in the tables; but when some basic relations have been isolated, others can be individuated by the machine on the basis of general rules of derivation. For instance, in the case of the relation "species-genus" (these terms, as can be seen from the tables, have not been used in their proper zoological sense) there is a rule that permits us to carry over, to a term classified as "species", all the relations that apply to the thing that has been classified as its "genus", excepting, of course, that of "species-genus" going in the opposite direction. E.g. if robin has been classified as a "species" of bird, and if bird has been placed in relation with egg and (to) fly, then the same relations can be assigned to robin, even without indicating them explicitly.

However, the relation "species-genus" which, e.g. sparrow has with bird is not transferred in this way to the word robin; i.e. one does not end up with sparrow classified as a "species" of robin.

Some relations, including that of "genus-species", "part-whole", "thing-material", etc.,

have the property of “transitivity”, within the limits of one and the same relation, and of a given direction of this relation. That is, it is enough to classify finger as a part of hand, hand as a part of arm, arm as part of body, in order to be able to obtain the relation of “part-whole” between finger and arm, or finger and body; i.e. between members of the group not contiguous with each other. As an example of the same rule with the classification “thing-material”, we may take suit-cloth-wool, where cloth is the material of suit, and wool the material of cloth and, therefore, automatically, wool is also the material of suit.

Another group of rules concerns the relations between activities and their complements. E.g. to paint has been put in a relation of “activity material” with colour; in a relation of “activity-result” with picture; of “activity-instrument” with paintbrush; from these relations it is possible, in fact, to infer that between colour and picture there is a relation of “material-result”, between picture and paintbrush a relation of “result-instrument”, etc. On the other hand, the above relations have been explicitly indicated for each case, when the dictionary does not contain a specific name for the activity concerned. E.g. we would indicate specifically the relation of “subject-result (of his activity)” between cobbler and shoe, because there is no word that one can use to indicate the activity itself, all one can say is that the cobbler makes shoes, and there is no reason why make, being a verb of pure transitivity, should be put in relation to one type of object rather than another.

The analyses in terms of constellations are carried out by taking one of the terms as an individual, at present, as we have said, the developments, but later also things with regard to their aspects, or aspects with regard to the things they characterize, etc., and taking the other term as a member of a class. We will thus, for example, take the verb “to pay” as an individual, and then the relevant classes will be “possessible things, things which can be bought and sold”; “possible possessors, people or organizations”; “prices, the values of things calculated in money”.

The constellations of about fifty developments, drawn up with particular regard to translation from Russian into English, Italian and German, will illustrate fully this procedure of analysis and classification. This research was carried out with the collaboration of Ernst von Glasersfeld, Sergei Perschke, Renzo Beltrame and Elsa Samet, researchers at the Centro di Cibernetica [9].

3. MODIFICATIONS OF THOUGHT IN THE COURSE OF TRANSLATION

“The first requisite of a translation, it seems to me,
is that it should not sound like a translation.”

—MARIANNE MOORE.

When the input text has been understood, that is, when the correlational net corresponding to the text has been constructed, it is not always the case that everything is ready for representation in the output language. For it is true that everyone thinks by means of opening and closing correlations, but if the contents of thought are, for two peoples in two different civilizations, partly held in common, one of the two will still be richer or poorer in certain ways than the other, or will arrive at a different solution when faced with a given situation; the expressions of each of the two languages in question will reflect these differences. The perfect translator is not he who forces the output language to assume the habits of the input language, but he who seeks to achieve in the output the solution which leaves as intact as possible the thought expressed in the input.

Italian, for example, offers an example of richness that cannot be paralleled in other

languages; a situation in which the two elements of an observational situation can be connected in eight different ways. Italian can say, of a pair of shoes, that they are “scarpe di punta quadrata”, “con la punta quadrata”, “dalla punta quadrata”, “in punta quadrata”, “a punta quadrata”, and so on (compare: “square-tipped shoes”, “shoes with a square tip”). All these are not, of course, synonymous expressions, but different ways of constructing the situation: for example the expression “dalla punta quadrata” indicates that it was the tip that attracted the observer’s attention before the whole shoe itself, and that he passed from the construction of the tip to the construction of the whole shoe; while the expression “a punta quadrata” indicates that the two constructions, in a manner of speaking, coincided; and so on. To translate the “da” into English with the word “from”, or the “a” with the word “at”, is quite impossible; whereas the translation of “con” by “with” gives us an example of correspondence. Here, therefore, we have a case where one thought may have to be replaced by another. This also happens, for instance, when we pass from the English phrase “to enter a shop” to the Italian “entrare in un negozio”; here the element “to enter” gives us the passage from outside to inside, while the addition of “in” in the Italian presents us further with the static situation of the subject being inside the shop.

3.1. *Types of transformation*

In the study of transformations, we first have to clear up certain problems of definition, classification, or terminology.

The first, naturally, is that of distinguishing between a non-transformative translation, in which the two expressions of thought can be said to fit, to correspond, in fact to be identical: to be one single thought, the only point of difference being in the graphic or phonetic material chosen to represent it in each case, and a transformative translation. A bilingual person is more or less able to decide whether what he says in one of his languages remains the same or is changed when he says it in the other; at least this is so if he pays attention to the question, for if not, his ease and spontaneity may make him less capable than anyone else of distinguishing any difference. A case of translation in which the thought is generally admitted to be identical is, for example, the Italian “cane”, the English “dog”, and the German “Hund”, and so too “cane e gatto”, “dog and cat”, “Hund und Katze”. We would, moreover, consider identical with these the thought represented by the Latin “canis et felis”; but supposing the Latin said “canis felisque”? Or supposing we had in Italian “il cane corre”, would the English “the dog runs” correspond to this, seeing that English distinguishes between the two cases of “the dog runs” and “the dog is running”?

For the purposes of mechanical translation it was necessary to provide an explicit criterion for what remained the same in translation and what was transformed; it was, moreover, also necessary to lay down the general conditions for the input and the output language for cases where transformation was carried out; for we have noticed that conditions necessitating transformation only occasionally occur individually, being generally identifiable by class or group. Clearly the criterion of equal richness in both languages, such that nothing is either gained or lost in transition, as against greater or lesser richness on the other hand, is wholly insufficient.

In one approaches the problem from the point of view of the linguistic expression, one could talk of there being a transformation when the number of words in one language, or their order, or both, were different from those in the other. According to this criterion we would have a transformation when passing, for example, from the Italian “unità’ di una esperienza” to the German “Einheit einer Erfahrung”, but not when passing from “unità’

dell' esperienza" to "Einheit der Erfahrung". One can, of course, perform such a transformation within one single language, as for instance when one replaces "con l'esperienza" with "coll' esperienza".

A system of translation that is intended to reflect the structure of thought makes it necessary to tackle the problem in a way that takes account of what happens to this structure. In the first place, one must consider whether:

- (a) the correlational structure of the thought, and the elements contained in it, remain the same; or
- (b) the structure remains the same and the elements in it change; or
- (c) the structure changes and the elements in it remain the same.

The criterion of equality for the elements of the correlational structure is easily given if these elements have been taken as members of a class; in this case one need only stipulate that the classes in each of the two cases should be the same. If the elements have been taken as individuals, as happens, for instance, with the correlators, then the criterion of equality must be further specified. For these cases we decided to take account of the results of the operational analysis carried out on the categories of relation that these elements designate. So that, for instance, if "or" has been found to be identical with the Italian "o", or with the German "oder", then the phrase "dog or cat" will not undergo any transformation when it becomes "cane o gatto", or "Hund oder Katze"; while it will be transformed when passing into the richer language of Latin, with its two alternatives "aut" and "vel", giving us either "canis aut felis" or "canis vel felis".

This means that as our analysis becomes more refined, that is, as our tabelloni are developed, a transition which at one stage did not involve a transformation, may at a further stage involve one.

Another question to be examined is the type of transformation carried out among the thought-structures. This transformation can be concerned with the relative positions of the structures, or with their relative size, or with both. For example, the Italian phrase "acqua molto sporca"

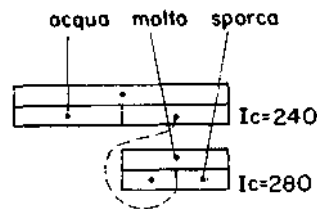

becomes in English "very dirty water"

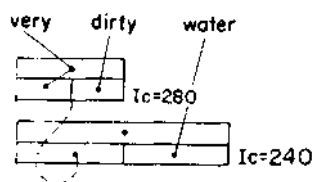

this being an example of the first type of transformation.

For an example of the second type we may look at the Italian “un tale uomo”, which becomes in English “such a man”.

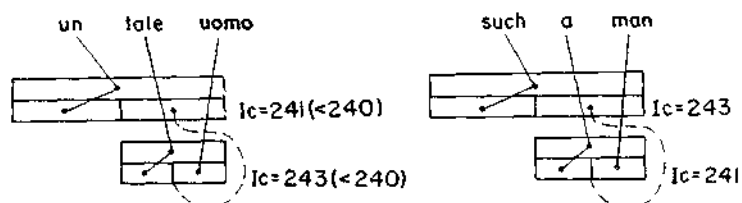

The size of the unit that is transformed also changes, of course. Sometimes we are dealing with one single correlation, sometimes with two or more, sometimes only with one or two of three elements that compose one correlation; in this last case we have seen that it is important to distinguish between the cases where it is the correlator that is changed, and those where it is one or other of the two correlata.

For example it is almost always the case that where one language has an active and a passive form of a given verb, and the other language has only the active, the transformation of a passive input into an active output involves the replacement of at least two correlations. The English “I am envied by all”:

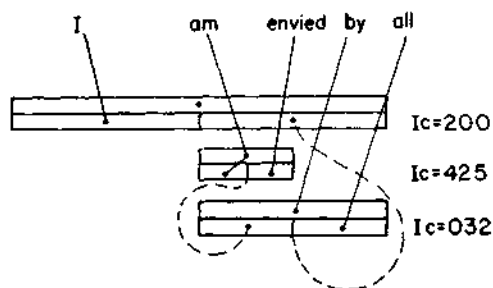

can be rendered in Latin by “omnes invident mihi”:

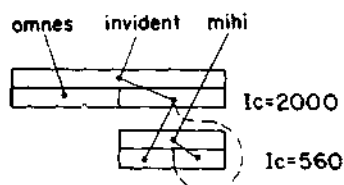

The importance of the situation where one correlator is replaced by another is explained by the stage our analysis has reached and by the fact that the majority of the correlations that compose the tabellone are designated by an index number connected to one correlator alone.

As regards the size of the units to be transformed, we must add that in some cases the number of correlations in the final result remains the same as before, in others it is greater and in others again it is less. As an example of this, it is sufficient to point out that the presence of an article in the output language always leads to an increase in the number of correlations if the input language has none, while if the input language has them and the output language has not, then the number of correlations decreases.

3.2. Conditions for transformation

We will illustrate the conditions which govern the process of transformation, by reference principally to a study carried out for the purpose of mechanical translation from English into Latin; these two languages were chosen because of the continual work of transformation that has to be carried out in translating from one to the other, caused by the many differences between the two languages.

As we have said, the work of the machine must be based on the correlational structures of the input language and the elements contained in these structures.

Sometimes the rule of transformation depends on the index number of the input correlation alone. For instance, when passing from an English input, containing articles, to a Latin output, without them, the index number that designates a correlation with an article as first correlatum will be sufficient to inform the machine that this is a correlation to be eliminated, only its second correlatum being retained, this second correlatum having, of course, not the correlational function it had in the input, but the correlational function which was attached, in the input, to the whole article correlation.

Sometimes the index number alone is not a sufficient indication, and needs to be supplemented by another condition. This is the case, for instance, when there is in English a correlation of subject-development (IC 200), classified as consecutive, i.e. appearing as second correlatum of a correlation such as IC 076 (sicche in Italian) or IC 088 (ut, in Latin), since here the verb, indicative in English, must be replaced by a verb in the subjunctive in Latin.

Thus: "He ate so much that he burst"

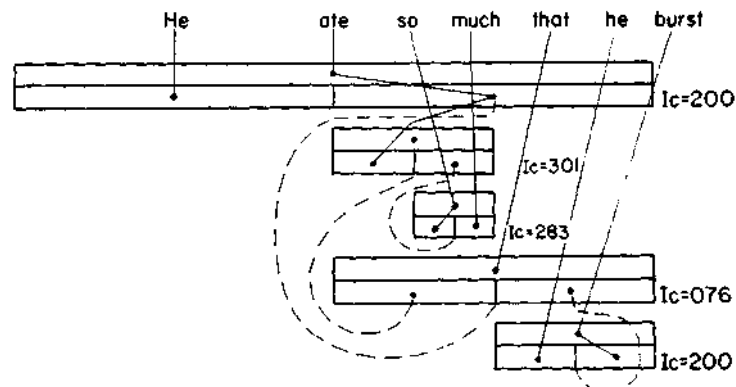

becomes in Latin: "Manducavit tantum ut dissiluerit".

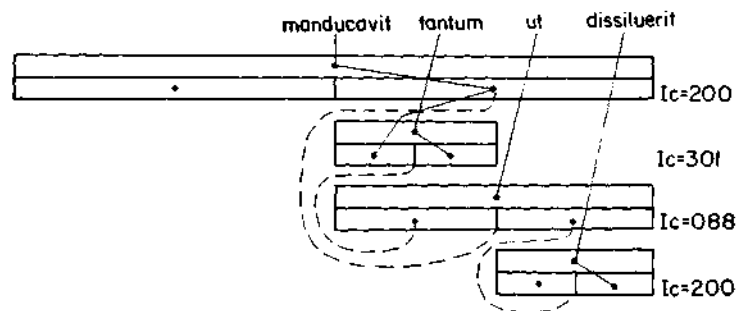

In other cases the rules of transformation take account of morphological peculiarities of the two languages; this is a consequence of the fact that we assign to each individual word the value of a semantic unit. In English, for instance, the comparative and the superlative are sometimes expressed in a single word, this being the case for all monosyllabic and some bisyllabic adjectives, e.g. "finer, finest", and sometimes in two words, when the number of syllables in the original adjective is greater. Latin, on the other hand, is almost always able to express them in a single word. It follows that the correlational net of an English input will occasionally contain a correlation which will be replaced in Latin by one correlandum alone.

Transformations based on the type of declension to which a Latin word belongs are of the same type. For example, the correlation that has the correlator "in" (even supposing that the English and the Latin words "in" can be held to designate the same mental category of relation) does not always remain the same; "in London" becomes "Londinii", with the locative case, because "Londinium" is a second declension noun; while "in Naples" becomes "Neapoli", in the ablative case, because "Neapolis" is a third declension noun.

It quite often happens, too, that a transformation depends both on the correlator, that is, on the index number of the correlation, and on the two correlata; we find an example of this when the first of the correlata is, in English, a verb like "to get", "to become", "to be", etc., i.e. correlations which convey a pure static or developmental situation, the equality or the difference between the two moments contained in the verb, without conveying the specific content of these moments. The English phrases "to be cold, to grow cold", for instance, will be rendered in Latin by "frigere, frigescere".

A number of examples of transformation, with the conditions for each case, will be found in the constellation tables prepared for the Russian verbs.

3.3. Rules for transformation

We will give here a more detailed example of the rules supplied to the machine for the making of transformations; here too we will make particular reference to the study carried out for a translation from English into Latin.

We have chosen rules intended for the eliminative type of transformation, i.e. for situations where the number of correlations is greater in the input than in the output. And we have here distinguished between correlations which do not contain other correlations as constituent elements, and those which do.

Examples of procedure. 1. Example of a case where the correlation to be eliminated is not composed of other correlations but of simple correlata, i.e. elements corresponding only to word-cards.

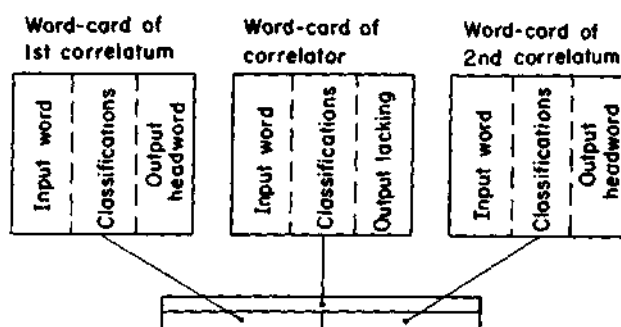

Two cases can be distinguished here: A. One of the two correlata does not carry on its word-card any corresponding term in the output language. (Note that the word-cards of the correlators never carry output-language correspondences.)

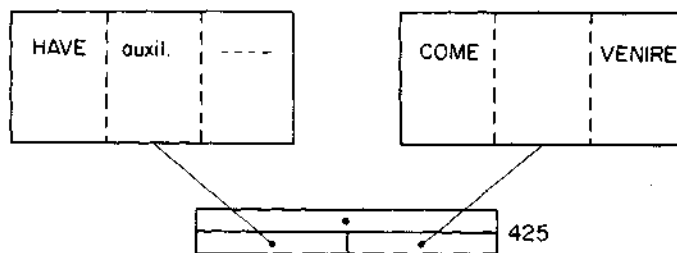

The input dictionary headword "have" does not correspond, *qua* auxiliary, to any output dictionary headword, since in Latin, tenses and moods of the active voice are formed by inflection alone.

In this case the product-card corresponding to the correlation that has been eliminated is replaced by a word-card containing all the classifications shown on the product matrix, and bearing, as its output dictionary headword, the output headword shown on that one of the two input word-cards that carried an output counterpart.

Example :

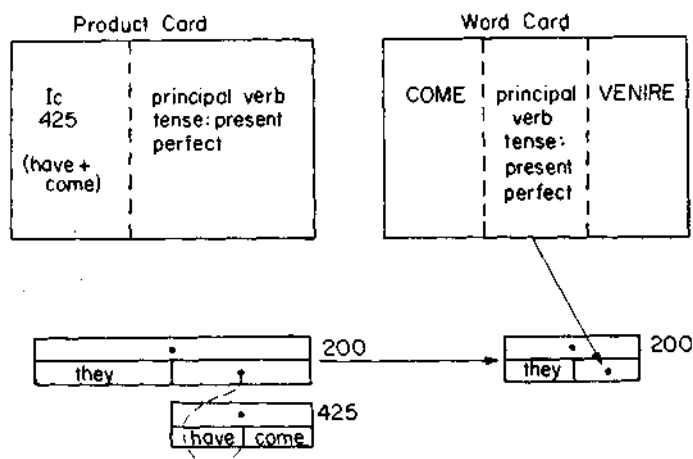

As can be seen in the above figure, the word-card that has thus been substituted for the product-card now takes the place of the eliminated correlation in the correlational net. B. Both the correlata carry, on their word-cards, counterparts in the output dictionary:

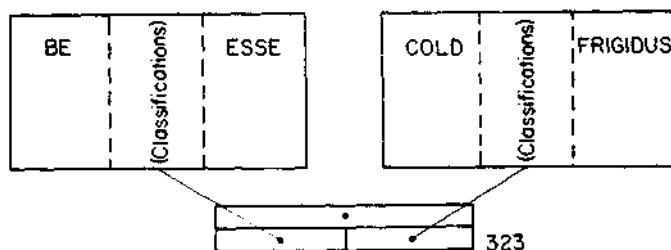

The correlation 323, copulative verb+predicative adjective, is not always transformed. In order to decide in each particular case whether it is to be transformed or not, the specific contents must be explored; in the present case they suggest that the correlation 323 should be eliminated.

At this stage, therefore, a "fusion table" is consulted; and this table will tell us that the two input headwords BE and COLD in the correlation together correspond to the single output headword FRIGERE.

In this case, too, the correlation is replaced by a word-matrix containing all the classifications of the eliminated correlation, together with the new headword FRIGERE. This card will occupy, in the correlational net, the place previously occupied by the correlation now eliminated.

There is a third case, C, which is never met with because of the rules of construction used. This is the case where neither of the correlata has an output counterpart on its word-card. Our procedure of construction does not allow this to take place. In a case such as: HAVE BEEN LOVING, where neither HAVE nor BEEN has a counterpart in Latin, since both of them are auxiliary verbs, the following correlation has been forbidden:

*

	•
have	been

which would then have been correlated with LOVING; instead, priority has been given to the correlational net which contains as I correlatum the word HAVE, and as II correlatum the words BEEN LOVING; thus this case too belongs to the general case where a correlation which is to be eliminated contains as its II correlatum an entire correlation.

2. Example of a case where the correlation that is to be eliminated is composed of other correlations, that is when the components of its product-card are in their turn composed of other product-cards.

Two cases can be distinguished here: A. Only one of the correlata corresponds to an entire correlation:

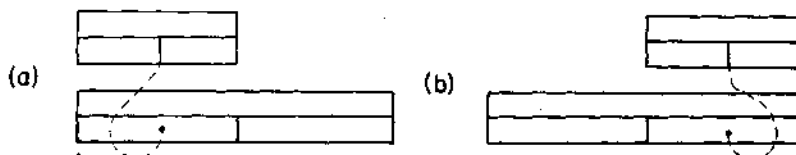

In each case the classifications of the correlation contained as I or II correlatum of the larger correlation are replaced by the classifications of the correlation that is to be eliminated. If the simple correlatum of the larger correlation (that is, the correlatum that does not comprise another correlation) contains a dictionary headword, then this is transferred to the position of the correlatum that has no output counterpart, in the smaller (contained) correlation.

(a) corresponds to expressions such as HAVE NOT LOVED;

(b) corresponds to expressions such as the HAVE BEEN LOVING, already examined.

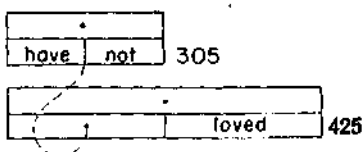

Product card of the correlation IC 425

IC 425
 Classifications: present, perfect, active, principal verb
 I correlatum: IC 305
 II correlatum: LOVE
 (output: AMARE)

Product card of the correlation IC 305

IC 305
 Classifications: present, active, auxiliary verb
 I correlatum: HAVE
 (output lacking)
 II correlatum: NOT
 (output NON)

Product card of the correlation IC 305, after elimination of the correlation IC 425

IC 305
 Classifications: present perfect, active, principal verb
 I correlatum: LOVE
 (output: AMARE)
 II correlatum: NOT
 (output: NON)

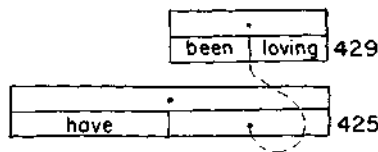

Product card of the correlation IC 425

IC 425
 Classifications: present perfect, active, continuous aspect, principal verb
 I correlatum: HAVE
 (output lacking)
 II correlatum: IC 429

Product card of the correlation IC 429

IC 429
 Classifications: past, active, continuous aspect, principal verb
 I correlatum: BE
 (output lacking)
 II correlatum: LOVE
 (output: AMARE)

Product card of the correlation IC 429, after elimination of the correlation IC 425

IC 429
 Classifications: present perfect, active, continuous aspect, principal verb
 I correlatum: BE
 (output lacking)
 II correlatum: LOVE
 (output: AMARE)

The two correlational nets, then, when they have been reclassified, become:

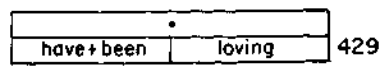
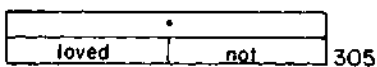

(a) This correlation will subsequently have to be transformed, by substitution, of IC, into the correlation which contains the same correlata in the reverse order:

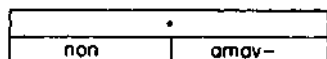

(b) This correlation is in its turn eliminated according to the rules already demonstrated for those correlations which do not contain other correlations. We will, therefore, have a word-card corresponding to AMAB-.

B. Both correlata correspond to entire correlations:

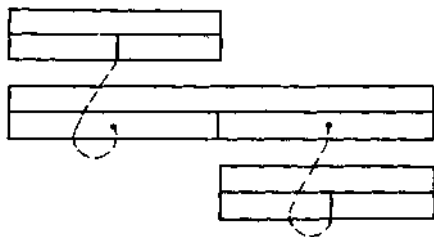

In this case, the small correlation contained as II correlatum of the larger receives all the classifications of the latter (which will itself be eliminated), and enters into the smaller correlation that acts as I correlatum of the larger, to occupy there the position which does not correspond to an output dictionary headword.

A net of this type would correspond to an expression such as for example:

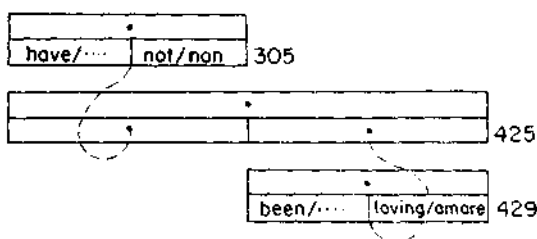

The subsequent stages of the transformation will therefore be:

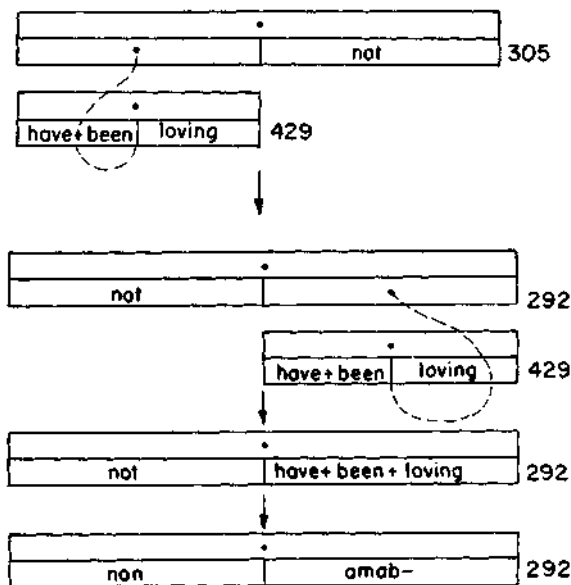

Note: As can be seen, when carrying out transformations of the net, we proceed from the largest rectangle to the smallest. This procedure holds not only for eliminations, but for all types of transformation.

4. THE PROCEDURE OF MECHANICAL TRANSLATION AND ITS PHASES, ILLUSTRATED BY AN EXAMPLE

A microexample of mechanical translation from Italian into English (prepared by Dr. Bruna Zonta), will best illustrate the way in which the research workers of the Centro di Cibernetica have approached and dealt with this problem. It is a "microexample" in every sense, because the dictionary it uses is minimal, containing only about twenty words, and because the correlations admitted for these words are only a small section of those which appear in the second-level correlational tabellone. But we decided that only by means of this deliberate simplification could the example be immediately followed and understood, which is essential if it is to serve as an illustration of procedure. For the same reason it has been drawn up with reference to a tabellone which represents a compromise between the first- and the second-level tabellone; a tabellone, that is, small enough to be presented in a single diagram, but large enough to give an impression of its use in the actual full-scale procedure.

Other classifications, on the other hand, have been left complete in this example—even where they are not procedurally relevant—to show their range as classifications and to maintain as far as possible the autonomy of the presentation of the example.

The sentence to be translated is also very short: “Un giglio ci sta bene”.

DICTIONARY

1. andare	6. ebbe	11. io	16. per
2. bene	7. fame	12. lui	17. sono
3. casa	8. giglio	13. mela	18. sta
4. cavallo	9. i	14. occhi	19. un
5. ci	10. il	15. pane	20. vanno

TABELLONE

032	“e”
064	“per”
129	subject + development
130	development + object
131	article
133	adjective as second correlatum
135	adverb as second correlatum
143	“ci” + development
155	development + dative

The first operation performed by the machine is that of numbering progressively, according to their linear sequence, all the words of the text to be translated, as far as the first full stop. This makes it possible to know, in the course of the procedure, which is the last word of the text, and so to carry out other operations taking account of this, before the input of the full stop itself. In our case, then, we have the following numeration:

Un(1) giglio (2) ci (3) sta (4) bene (5).

The word-card corresponding to the first word is then extracted from the dictionary.

Word-card No. 19: UN

tabellone Nos. (IC)	131/1
case	—
number	singular
person	—
gender	masculine
mood	—
tense	—
function	—

Every word-card contains in numerical form all the combinatory possibilities assigned by the linguist to the word, and a certain number of other classifications, introduced for the checking of agreement and of the acceptability of correlata on other grounds. Every

word-card, then, has as many tabellone-numbers as the word has correlational possibilities, and each of these numbers is accompanied by the indication of the place in the correlation which can be occupied by the word (i.e. 1 for the first correlatum, 2 for the second correlatum, and 3 for the correlator).

Word-card No. 19 contains only one tabellone-number:

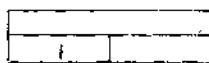

131 (The number 1 in the first box refers to the initial numeration of the input words.)

and, of the other classifications, only those which may be needed in the control procedures of the ten correlations included in this example.

Next the word-card of the second word is extracted from the dictionary:

Word-card No. 8: GIGLIO		
tabellone Nos.	032/1	064/1
	032/2	064/2
	129/1	133/1
	130/2	131/2
case	—	
number	singular	
person	—	
gender	masculine	
mood	—	
tense	—	
function	—	

It contains the following correlational possibilities:

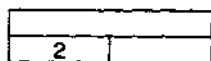

032, 064, 129, 133

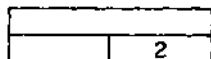

032, 064, 130, 131

The correlation forms corresponding to the first word are now combined with those corresponding to the second.

Since the two general rules of identity of the tabellone-number and of complementarity of position limit the acceptable combinations, we have as the only acceptable possibility:



131

derived from:

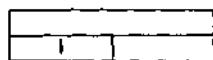

131

+

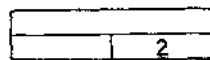

131

At this point the control-card of the correlation 131 is looked up, to find out whether any particular conditions restrict the acceptance of the two correlata.

Control card (acceptance card) of correlation 131 (ARTICLE)

Conditions of order: the first correlatum must always precede the second.

Conditions of interval: no other words may occur between the first and the second correlatum.

Conditions of agreement:

(1) if the second correlatum is masculine, the first must also be masculine; if the second is feminine, the first must also be feminine; if the second correlatum has no classification of gender, the first must be masculine.

(2) if the second correlatum is singular, the first must also be singular; if the second is plural, the first must also be plural; if the second has no classification of number, there is no restriction on agreement.

Since all the conditions stated on this card, of order, interval and agreement between the correlata, are satisfied in the present case (as can be seen by reference to the word-cards of the correlata), the correlation 131, composed of the first two words of the text, is accepted and reclassified; that is, its own correlational possibilities as a single correlatum, in terms of tabellone-numbers, are assigned to it by the machine. The rules of reclassification associated with correlation 131 provide that all the combinatory possibilities which belonged to its second correlatum can be reassigned to the correlation as a whole, with the exception of the possibility of being second correlatum of a correlation 131 again. Special restrictive rules further exclude certain possibilities, depending on the position which the completed combination occupies in the discourse; correlation 131, for instance, although in itself it has the possibility of being second correlatum of an "e" ("and") or a "per" ("for"), loses these possibilities if it is made of the first two words of a text, because the acceptance rules of the correlations made with "e" and "per" exclude the sequences of: second correlatum—correlator—first correlatum, and: second correlatum—first correlatum—correlator. There will, therefore, be the following reclassifications:

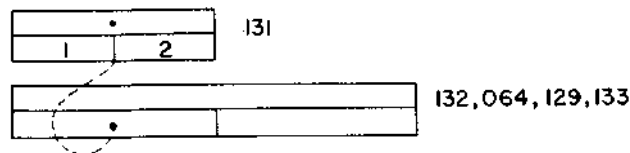

and

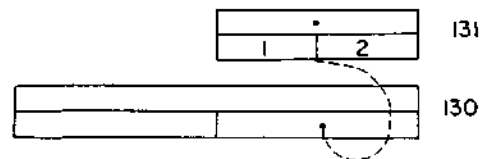

With a view to later combinations, the combinatory possibilities of the single words are also retained in the machine, even those which have already been used in combinations. For example, here, word 1's possibility of being first correlatum of the correlation 131 is retained, because it could still be used if the words which followed, formed, together with

word 2, a group reclassified as a possible second correlatum of 131; this would happen, for example, if the third word proved to be "solo", which would combine with "giglio" to form a possible second correlatum to "un"; the phrase would then be "un giglio solo" ("a single lily").

All the possibilities of the second word are also retained, except those of being second correlatum of correlations 032 and 064, both excluded by rules of order. The correlational forms which remain open prior to the input of the third word are therefore the following:

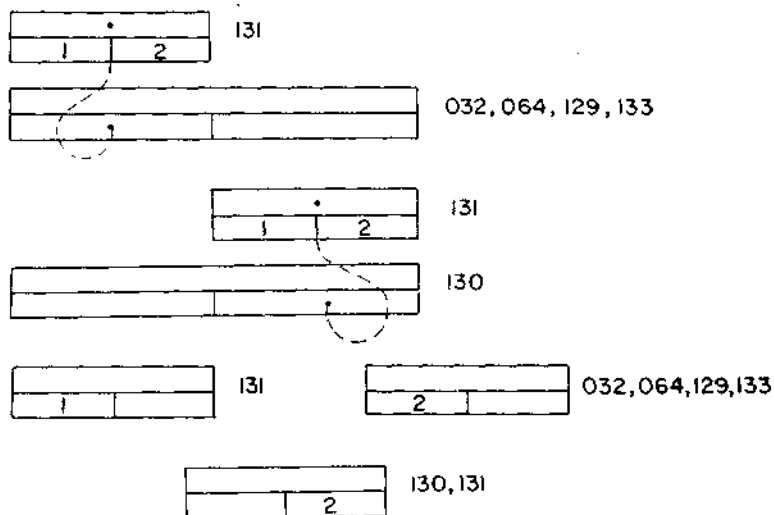

The third word-card is then extracted from the dictionary, with the following correlational possibilities:



which are combined with the five possibilities transcribed before; and since the combination produces no results, owing to the incompatibility of tabellone-numbers and because of the rules of complementarity of position—the word-card of the fourth word is extracted:

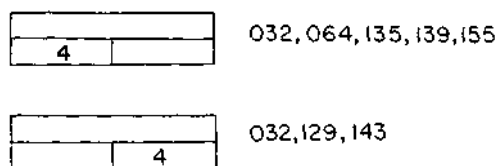

The correlational forms are combined with all the transcribed ones, to which the possibilities of the third single word have now been added. Taking into account the general

rules of combination, the restrictive conditions contained on the control card, and the subsequent discard rules, we obtain only the two following combinations:



which, reclassified, give rise to the following possibilities:

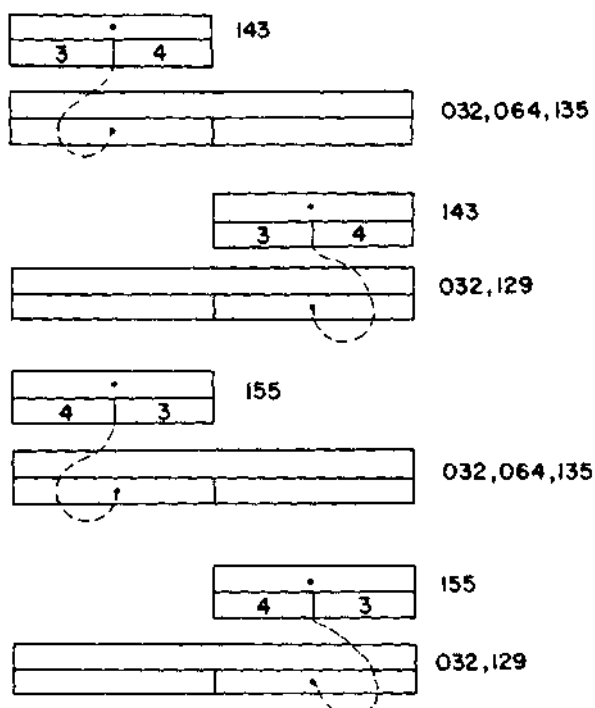

Since, in this combination, we have obtained results which do not contain all the words of the input text so far, before the fifth and last word-card is extracted we *recombine* the results obtained and reclassified in this last combination with the correlational forms pertaining to the other words (that is, words 1 and 2) which we already have. This operation, which allows us to combine results from different combinations with one another, and also

results of combinations with correlational possibilities belonging to earlier single words, is called *circulation* and is carried out according to all the usual combination and control rules. From it we obtain the following new results:

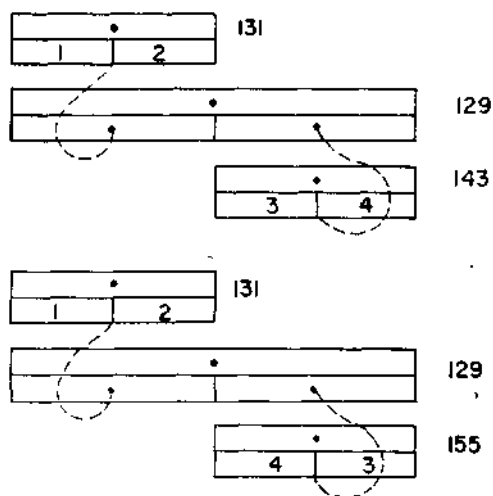

with their respective reclassifications.

Since these results of circulation now include the whole text fed in so far, they and their reclassifications (each, in fact, is reclassified only as 032/1) are transcribed together with all the preceding results and all the other correlational forms which are still usable, and circulation is regarded as complete for this cycle.

After the extraction of the word-card of the fifth and last word of the text, with its possibilities:

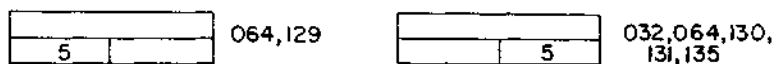

and the combination of these possibilities with all those previously transcribed, the following results are obtained:

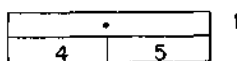

(reclassified with all the classifications of its first correlatum, except 135/1); and:

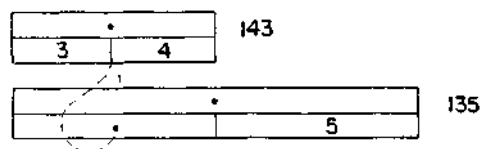

(reclassified in the same way); and:

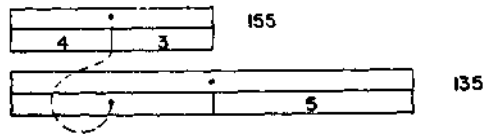

The circulation of these results with the preceding correlational forms produces, by various routes, no fewer than four nets each of which involves the whole of the input text; they are as follows:

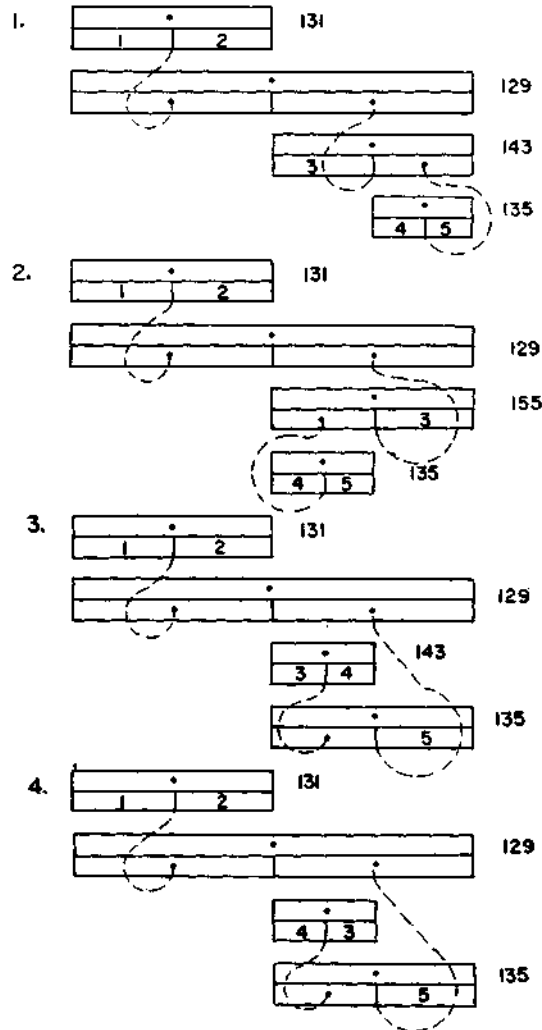

These four final nets represent four possible readings of the expression “un giglio ci sta bene”.

The first corresponds to the sense which the expression has in the context “Tra le rose

e le viole anche un giglio ci sta bene”—literally, “among the roses and the violets a lily also stands well there”—where “ci”, “there”, has its value of “localizing particle”, and the verb “stare” is taken together with the adverb “bene” to make a new development with a particular idiomatic meaning.

The second net presents, as a variant of the first, the word “ci” taken as a “pronominal particle”, with the sense of “to us”, “for us”.

The third net, on the other hand, corresponds to the meaning which the phrase has if we take “ci” and “sta” together, composing the verb “starci” as supposed to the verb “stare” (literally “to stand there”) and correlating this product with the adverb “bene”.

The fourth and last net presents, again, “ci” combined with “stare”, but in its pronominal sense (producing the literal meaning “to stand to (or for) us”), and then combined with the adverb “bene” as before.

All four of these nets are carried on towards the output procedure, while the rest which do not contain all the words of the text are cancelled.

Here we will follow out only the first of the four nets through the output procedure.

Before the actual output, the net is examined for any *transformations* which it may require, where the thought expressed by the input text does not find an exactly correspondent thought which is expressible in the output language, but does find a thought which contains the same *information* but with a different temporal distribution. A correlational net may be transformed either by adding correlations to it, or by dropping correlations from it, or by replacing one type of correlation by another. The need to transform the net may be absolute, that is, when a certain number in the tabellone of one language has no equivalent in the tabellone of the other; but it may also arise from the specific contents of the correlation. In our case, for example, the correlation 143, characterized by “ci”, has an equivalent in English (the correlation with “there”, as in “there is a story”), but this correlation does not have corresponding conditions; that is, the list of developments which can function as second correlatum to “there” is much more limited than in the case of “ci”.

It will, therefore, be necessary to transform the net by the elimination of one correlation; we will have, then:

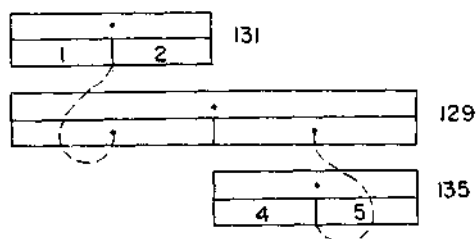

Since there is no other occasion to transform the net as it now stands, the actual output procedure can begin. First of all, the correlation which, in this net, contains all the others and is not contained by any other is examined by the machine, and we ask if in the English language there exists the possibility of expressing explicitly, by a word or a phrase, the correlator “subject-development”. Since in English (as, indeed, in Italian) this possibility does not exist, the position of first correlatum of this correlation is explored next. If this place contains no further correlations, but only a single word, this word is looked up in the output dictionary and is registered in the form of a dictionary head-word (nominative,

infinitive, singular, etc.). If, on the other hand, as in this case, the position is occupied by a further correlation, the largest contained correlation is isolated and examined in the same way and in the same order as the first.

When all the contents of the correlations have been registered, their inflection begins, according to the correlational rules of the output language, moving from the words which dominate agreements to the words which are dominated by these agreements.

Here, then, is the development of our final net through the various phases of the output procedure:

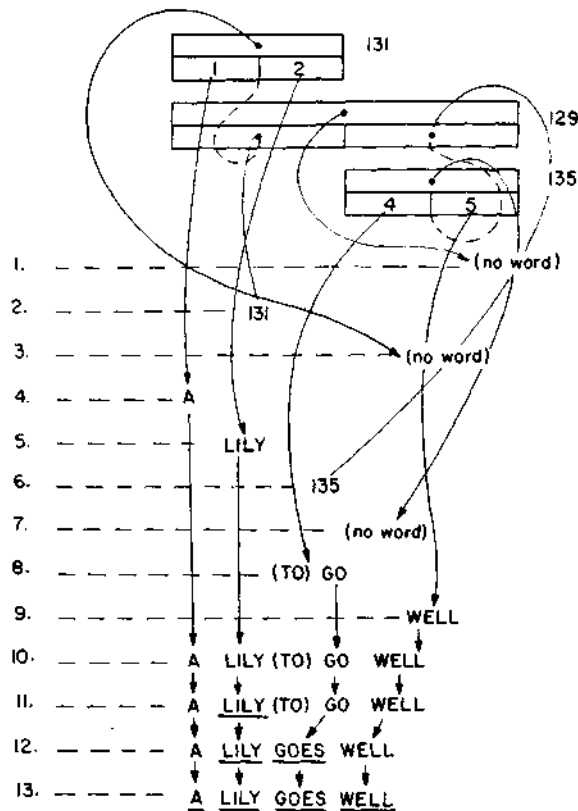

REFERENCES

- [1] S. CECCATO: L'Ecole operationelle et la rupture de la tradition cognitive. *Bulletin de la Société Française de Philosophie*, 1952-3, II, 46-47. Paris: Librairie Armand Colin, pp. 41-85.
- [2] S. CECCATO: La machine qui pense et qui parle. *I Congrès International de Cybernétique* (Namur, 1956), pp. 288-99. Paris: Gauthier Villars, 1959.
- [3] S. CECCATO: La meccanizzazione delle attività umane superiori. *Civiltà delle Macchine*, Roma, IX-4 (1961), pp. 22-29; ix-5 (1961), pp. 55-61; x-2 (1962), pp. 58-70.
- [4] S. CECCATO: Suggestions for anthropology: the machine which observes and describes. *The Use of Computers in Anthropology*. Wenner-Gren Foundation for Anthropological Research (Burg Wartenstein Symposium, 1962). Mouton and Cie, in press.

- [5] S. CECCATO: Principles and classifications of an operational grammar for mechanical translation. *Information Retrieval and Machine Translation*, **III**, 2, pp. 693-713. New York and London: Interscience Publishers, Inc., 1960.
E. MARETTI: How to represent and rule Correlating. *Ibid.*, pp. 713-38.
E. ALBANI: Construction of the correlational net by means of digital computers. *Ibid.*, pp. 738-53.
- [6] S. CECCATO and B. ZONTA: Human translation and translation by machine. *The First International Conference on MT, National Physical Laboratory (Teddington, 1961)*. Paper 30.
- [7] S. CECCATO: Operational linguistics and translation. *Linguistic Analysis and Programming for MT*, pp. 11-80. Milano: Feltrinelli Editore, 1961. New York: Gordon and Breach Publishers, 1961.
E. MARETTI: Figurative representation of operational procedure. *Ibid.*, pp. 141-69.
E. ALBANI: Correlational net and digital computers. *Ibid.*, pp. 197-220.
- [8] S. CECCATO: Thought as the basis of mechanical translation and summarising. *Colloque sur la Cooperation en Matière de Documentation et d'Information Scientifiques et Techniques*. Milano, November-December 1960.
- [9] R. BELTRAME: List of classifications. *Linguistic Analysis and Programming for MT*. (See [7].)
E. GLASERSFELD: Some notes on interlanguage correspondence. *Ibid.*, pp. 117-29.
S. PERSCHKE: Some notes on Ambiguous Russian verbs. *Ibid.*, pp. 130-40.
E. SAMET: Analysis of developmental situations in Polish with a view to finding adequate English equivalents. *The First International Conference on MT*. (See [6].) Paper 31.
S. PERSCHKE: Operational analysis of verbs. *Euratom CETIS Rapport*, No. 24 (1962).
- [10] J. BARTON: The application of the article in English. *The First International Conference on MT*. (See [6].) Paper 32.